



**PACIFIC COLUMNS &
ARCHITECTURAL DEPOT**
VOLUME VII

what we **MAKE**

Our exterior shutters are crafted in a variety of high quality materials designed to meet your needs. Whether you seek popular vinyl, durable fiberglass, or authentic wood shutters, we have an ideal shutter for any exterior.

SHUTTERS

Stately, elegant and bold, Endura-Series Composite Architectural Columns are historically inspired, entirely beautiful, and fully load bearing. Our Endura-Series Composite Architectural Columns bring traditional appeal and modern durability - an excellent alternative to traditional stone columns.

COLUMNS

Balustrade is one of the finest architectural elements that exists. We designed the absolute best balustrade product on the market. FiberThane is the only light-weight system that can span 16' lengths without needing a newel post or column.

BALUSTRADE

We have the largest collection of decorative crown moulding in the industry, with hundreds of different designs available. But we don't just carry one type of moulding: we also supply many other types of moulding, including panel moulding and chair rail. To help keep your project simple, we have 'Miter-Free' solutions that are absolutely revolutionary.

MOULDING

Our medallions and domes are modeled after original, historical patterns and designs. The installation is quick and easy due to the lightweight material. To make things even easier they come primed, ready-for-paint, or in faux finishes. Don't be afraid to cut, drill, screw, or glue these products.

**MEDALLIONS
& DOMES**

THOUSANDS OF OPTIONS



Our product lines are enormous! We carry thousands of products with some product lines boasting several hundred variations. If you don't find something you love, check our website or give us a call to find out what we have in stock.

SPEND LESS MONEY

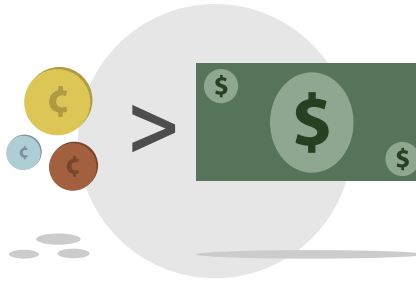

Get the most bang for your buck. We aim to sell the highest quality products for the lowest possible price. If the price is lower somewhere else, call us! We want to make that right by beating the price and leaving you with some extra money in your wallet!

GET YOUR PRODUCTS FASTER



Simply put, our lead times are the fastest out there. You won't find a company that can process and ship your order faster. Some products can be shipped out in 24 hours and we also provide expedited shipping options to make sure your products make it there on time.

Both load bearing and decorative our brackets and corbels come in wood, urethane, and metal. You are bound to find something that suits your project because we have the largest selection of brackets and corbels in the industry. We carry both modern and traditional designs.

BRACKETS
& CORBELS

Our gable vents come in thousands of sizes and designs, and can be functional or decorative. We make these in a variety of standard sizes and can do custom sizes, as well. Since we like to give as many options as possible, we make these in wood and urethane.

GABLE
VENTS

Crossheads are great for windows and doors. We carry virtually any size that can be installed interiorly or exteriorly. Crossheads make it easy to dress up any entryway.

CROSSHEADS

Metal brackets add an elegant look while also serving as countertop supports. Made from 1/4" thick steel and with a corrosive-resistant finish, our brackets are made to withstand the toughest applications. Pre-drilled mounting holes ensure seamless installation.

METAL
BRACKETS

Our Rustic Collection is an instant classic. Our Rustic wood millwork utilizes technologies of today to build the 'log and timber' wood products that have been in architecture for centuries. Because these products are not kiln dried, each item in our Rustic Collection is 100% unique. Within the Rustic Collection there are natural variations that make this collection stand out from the rest.

RUSTIC
SERIES

NEED AN INSTALLER?

WANT TO FEEL COMFORTABLE WITH A CONTRACTOR? HIRE A LOCAL PRO!

The Local Pro Partnership program is a network of thousands of industry-related professionals all across the country who have worked with us recently, are familiar with our product lines, and have been certified to be our Partner in your area. They are the top pros in your city that are familiar with our products!

How do we verify the quality of these installers and designers?

- Credit Checks
- BBB Review
- Verified Contactor Number or Industry Status
- Reputation Check with Prior Customers
- Reviewed on Yelp
- Certification Test and Screening Process
- And Much More!

Have you ever been looking for a contractor but weren't sure where to start or what qualifications to look for? We understand. That is why we created the Local Pro Partnership Program. We combed the country looking for the best contractors, builders, designers, and architects who specialize in millwork and have worked with our products before. These companies then applied to be a part of the program, and only the best passed and became our Local Pros. If you need help with columns, shutters, millwork, or any product we make, these are the guys to call!



**FIND OUR
LOCAL PROS**

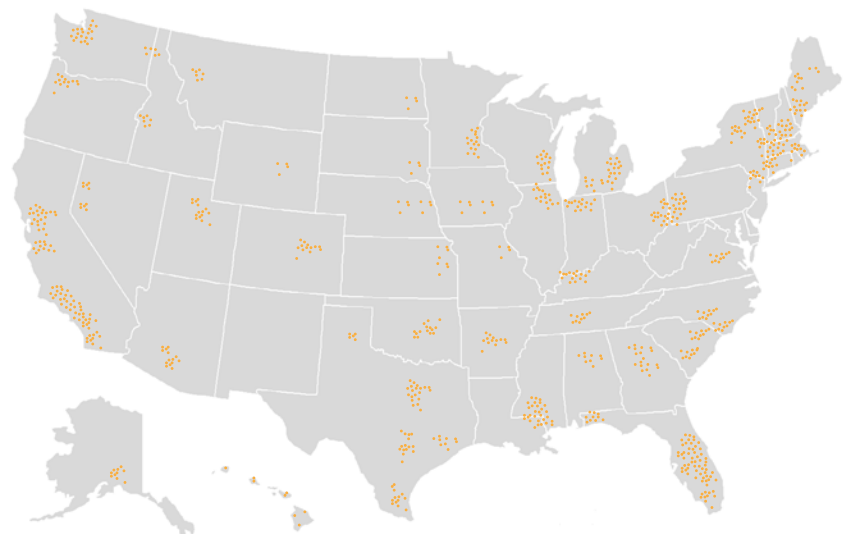

LOCAL PRO

partnering with contractors, installers, designers, & architects

WHO ARE LOCAL PROS?

Our network of Partners consists of the top builders, contractors, installers, trim specialists, designers, and architects who have passed our application process and are certified to be our Partner in your area. Not only do these local companies have great reputations, but because they work with our products on a regular basis, you can rest assured knowing they are the perfect fit for your project.

Are you a contractor, builder, designer, architect, cabinet shop, or trim specialist interested in learning more about our Local Pro Program? We have a dedicated phone line and email address just for you. Call us before all spots are taken.

855-573-3768

prodesk@architecturaldepot.com

visit **www.architecturaldepot.com/pro.html**
for the application and more info

Learn the benefits of being a Local Pro!

Why Hire a Local Pro?

- Discounted Pricing
- Faster Lead Times
- Free Samples
- Extensive Product Knowledge

Local Pro Partners receive a full package of tools designed to ensure your project is completed exactly how you want it to be, within the time frame you want it done, and for the overall best value.



table of **CONTENTS**

8
SPECIALTY

60
EXTERIOR

134
INTERIOR

Columns	8	Crossheads	60	Crown Moulding Systems	134
Balustrade	24	Pediments	70	Crown Moulding	154
Railing	36	Pilasters & Casing	72	Universal Moulding Blocks	196
Shutters	42	Capitals	74	Panel Moulding Systems	200
		Plinths and Bases	80	Panel Moulding	216
		Urethane Gable Vents	84	Ceiling Medallions	256
		Wood Gable Vents	90	Ceiling Domes	290
		Rustic Collection	112	Ceiling Rings & Tiles	294
				Brackets	304
				Corbels	312
				Appliques and Onlays	326
				Left & Right Onlays	348
				Drop & Swags	354
				Rosettes	360
				Stair Brackets	366
				Niches	370
				Sconces & Shelves	374

382 CARVINGS

434 METAL

460 INDEX

- 382 Wood Corbels
- 400 Wood Brackets
- 410 Wood Rosettes & Onlays
- 424 Wood Capitals & Bases
- 426 Wood Ceiling Medallions
- 428 Wood Cabinet Columns
- 430 Wood Crown Moulding

- 434 Metal Brackets
- 446 Iron Brackets

PACIFIC COLUMNS ARCHITECTURAL DEPOT
pacificcolumns.com architecturaldepot.com
505 W. LAMBERT BREA, CA 92821 505 W. LAMBERT
800.294.1098 BREA, CA 92821
714.257.9600 714.706.4370

COLUMNS

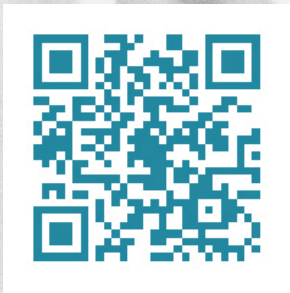

ENDURA-STONE (FRP)



- Load Bearing & Decorative Options
- Interior & Exterior Application
- Architecturally Correct
- Water/Heat/Cold Proof
- Cost Effective
- Available to Ship in 24 Hours
- Lifetime Warranty

ENDURA-CRAFT (EXPANDED CELLULAR PVC)



- Virtually Unlimited Sizes & Designs
- E-Z Lock Joint Assembly
- Wood-Like Feel and Workability
- Water/Heat/Cold Resistant
- Cost Effective
- Pre-Colored White
- Lifetime Warranty

ENDURA-CLASSIC (FIBER-RESIN INFUSION)

- Load-Bearing & Decorative Options
- Great for Large Diameters & Heights
- Virtually Unlimited Sizes
- Architecturally Correct
- Water Proof
- Heat/Cold Proof
- Factory Primed



ENDURA-LUM (ALUMINUM)

- Load Bearing & Decorative Options
- Pre-Colored
- Cost-Effective
- Water Proof
- Diameters 3" to 24"
- Heights 2' to 24'
- Available to Ship in 24 Hours



WOOD (ARCHITECTURAL WOOD)

- Virtually Unlimited Sizes & Designs
- Architecturally Correct
- Available in Any Wood Species
- Highest Quality Wood Available
- Stain-Grade & Paintable Options
- Most Crisp Detail in the Industry
- Exterior & Interior Grades Available



||| IN A T I O N W I D E
||| QUICK SHIP

as quick as same day shipping

COLUMN CAPS & BASES



ROMAN IONIC

column diameter	capital height	capital abacus	scroll to scroll
6"	2-1/4"	6-1/4"x6-1/4"	8-1/4"x5-7/8"
8"	3-1/2"	9-1/2"x 8-3/8"	13-1/4"x8-5/8"
10"	4-3/4"	12-1/4"x 10-1/2"	14-1/4"x10"
12"	5"	12-7/8"x12-5/8"	15-7/8"x10-3/4"
14"	5-5/8"	17-3/8"x16-7/8"	22-3/4"x15-1/2"
16"	6-3/8"	18"x17-7/8"	23-1/2"x15-7/8"
18"	6-1/2"	21"x21"	26"x18-1/2"
20"	9-1/4"	25-1/8"x24-1/2"	31-3/8"x22-1/8"
24"	9"	25"x24-5/8"	32-5/8"x21-3/8"



SCAMOZZI

column diameter	capital height	capital abacus	scroll to scroll
6"	2-1/2"	6-1/4"x6-1/4"	7-3/4"x7-1/2"
8"	3-3/8"	9-7/8"x9-1/2"	9-1/2"x9-1/2"
10"	4-1/8"	14"x13-1/8"	13-1/8"x13-1/8"
12"	5-1/8"	15-7/8"x14-1/4"	14-1/2"x14-1/2"
14"	5-3/4"	17-3/8"x16-7/8"	18-5/8"x18-1/2"
16"	5-7/8"	18"x17-7/8"	21-3/4"x21-5/8"
18"	7-3/8"	21"x21"	23-1/2"x23-1/2"
20"	8-1/2"	25-1/8"x24-1/2"	25-1/2"x25-1/4"
24"	11-1/4"	25"x24-5/8"	34-5/8"x34-1/2"



TEMPLE OF WINDS

column diameter	capital height	capital abacus
6"	7-7/8"	7-7/8"
8"	6-3/4"	10"
10"	8-7/8"	13-1/4"
12"	10-1/4"	15-1/4"
14"	14"	21"
16"	16-3/8"	22-3/4"x22-5/8"
18"	18-3/8"	26"x25-5/8"
20"	21-3/8"	28-3/8"x28-1/4"
24"	26"	30-7/8"x30-3/4"



ROMAN DORIC ORNAMENTAL

column diameter	capital height	capital abacus
6"	4-1/8"	8-3/4"x8-5/8"
8"	4-1/2"	10-3/8"
10"	5-3/4"	13-5/8"
12"	7"	15-1/2"
14"	7-1/4"	17-1/2"x17-1/2"
16"	10-7/8"	23-5/8"x23-12"



EMPIRE

column diameter	capital height	capital abacus	scroll to scroll
6"	3-1/2"	9-3/8"x9-1/8"	9-1/2"x9-1/2"
8"	4"	10"x10-1/4"	10-1/8"
10"	5-5/8"	14-1/8"x14-1/4"	13-1/2"
12"	7"	17-3/8"x16-7/8"	17-3/8"
14"	7-1/2"	20-3/8"x20-1/4"	21-1/2"x21-3/8"
16"	8-1/2"	21-3/4"x21-5/8"	23"x22-7/8"
18"	10"	30-3/4"x30-5/8"	30-1/4"x30-1/4"



ROMAN CORINTHIAN

column diameter	capital height	capital abacus
6"	7-1/8"	9-3/8"x9-1/4"
8"	8-3/4"	12-3/8"x12-1/8"
10"	11"	11-7/8"
12"	13-3/4"	14"
14"	15-1/4"	18-1/8"
16"	17-3/8"	23-5/8"x23-1/2"
18"	21-1/8"	28"x27-3/4"
20"	*24-3/4"	38-1/2"x38-1/2"
24"	*27-3/4"	42"x42"

[*] add 5/8" for plug height



GREEK ANGULAR IONIC

column diameter	capital height	capital abacus
8"	4-1/8"	9-5/8"x9-1/2"
10"	5-7/8"	15-1/2"x15-3/8"
12"	6"	18-1/4"x16-5/8"



GREEK ERECHTHEUM

column diameter	capital height	capital abacus	scroll to scroll
6"	3-1/4"	6-3/4"x6-1/2"	8-1/4"x5-5/8"
8"	3-3/4"	7-3/4"x8"	11-3/4"
10"	5-3/4"	10-7/8"x10-1/4"	17"
12"	6-3/4"	13-5/8"x12-7/8"	20-3/8"x13-1/4"
14"	7"	15"x14-1/4"	20-3/4"x13-3/8"
16"	9-1/4"	17-1/2"x17-3/8"	25-7/8"x17-1/4"

**DON'T SEE
WHAT YOU
NEED?
WE HAVE
MORE!
ASK US.**

COLUMN CAPS & BASES

CUSTOM CUTS

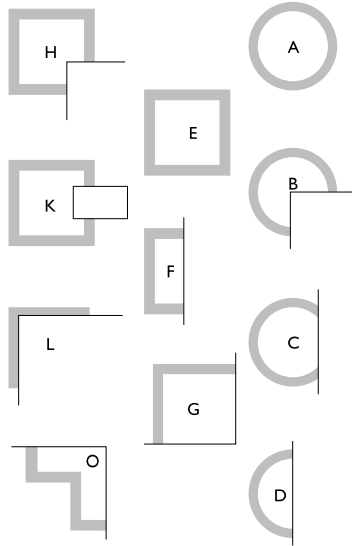

PLAN TYPE APPLICATIONS

- A/E** unsplit/whole
- B** 1/4 cut out for outside corner
- C** 1/4 cutout for pilaster
- D/F** split in 1/2 (two halves)
- Q** 1/4 cutout for inside corner
- L** cutout for outside flash wall wrap
- K** cut out for a wall wrap
- G** cut out for an inside corner
- H** cutout for an outside corner

*please specify exact dimensions when purchasing custom split or cutout plan types



TUSCAN CAPITAL

column diameter	round			abacus		total
	E	F	G	H	I	G-H
6"	1/2"	31/32"	31/32"	1-1/16"	7-1/2"	2-1/32"
8"	1/2"	1-3/4"	1-5/16"	1-3/8"	9-7/8"	2-11/16"
10"	3/4"	1-5/8"	1-13/16"	1-3/4"	12-5/32"	3-9/16"
12"	3/4"	1-3/32"	1-29/32"	2"	14-5/8"	3-29/32"
14"	1"	2-9/32"	2-15/32"	2-5/16"	16-31/32"	4-25/32"
16"	1"	2-1/4"	2-23/32"	2-23/32"	19-3/32"	5-7/16"
18"	1"	2-1/4"	2-31/32"	2-31/32"	21-5/16"	5-15/16"
20"	1-5/16"	2-3/4"	3-1/8"	3-7/16"	24-1/4"	6-9/16"
24"	1-5/8"	4-3/4"	3-3/16"	4-1/8"	28-3/4"	7-5/16"



TUSCAN BASE

column diameter	plinth		base moulding		total
	A	B	C	D	B-D
6"	7-31/32"	1-1/2"	1-1/4"	15/32"	3-7/32"
8"	10-7/8"	1-7/8"	1-3/4"	5/8"	4-1/4"
10"	13-1/2"	2-3/8"	2-1/8"	3/4"	5-1/4"
12"	16-1/4"	2-3/4"	2-3/8"	7/8"	6"
14"	18-19/32"	3-11/32"	3-31/32"	1"	7-5/16"
16"	21-5/16"	3-27/32"	3-11/32"	1-1/8"	8-5/16"
18"	24-1/32"	4-7/32"	3-31/32"	1-3/8"	9-9/16"
20"	27"	4-3/4"	4-1/6"	1-3/4"	10-9/16"
24"	32-1/2"	5-3/4"	5-1/4"	2-1/4"	13-1/4"



ATTIC BASE

column diameter	plinth			base moulding			total
	A	B	C	D	E	F	B-F
6"	n/a	n/a	n/a	n/a	n/a	n/a	n/a
8"	10-7/8"	1-7/8"	1-1/8"	7/8"	3/4"	1/2"	5-1/8"
10"	13-1/2"	2-3/8"	1-1/4"	1-1/8"	7/8"	5/8"	6-1/4"
12"	16-1/8"	2-3/4"	1-1/2"	1-3/8"	1"	5/8"	7-1/4"
14"	18-1/2"	3-5/16"	1-3/4"	1-21/32"	1-1/4"	11/16"	8-21/32"
16"	21-3/16"	3-3/4"	2-7/32"	1-7/8"	1-15/32"	13/16"	10-1/8"
18"	23-15/16"	4-7/32"	2-11/32"	2-1/8"	1-7/16"	1-1/8"	11-1/4"
20"	27-1/16"	4-3/4"	2-11/16"	2-3/8"	1-3/4"	1-7/16"	13"
24"	32-1/8"	5-3/4"	3-5/16"	2-13/16"	2-1/8"	1-3/4"	15-3/4"

IN A T I O N W I D E
Q U I C K S H I P

as quick as same day shipping



Round Tapered



SHAFT SPECIFICATIONS

outside diameter		inside diameter		fluting specifications	
bottom	top	bottom	top	number	width
6"	4-7/8"	4-3/4"	3-3/4"	n/a	n/a
8"	6-1/2"	6-3/4"	5-1/2"	24	11/16"
10"	8-1/2"	8-3/8"	7-3/4"	24	7/8"
12"	10"	10-3/4"	9-1/4"	24	1"
14"	11- 1/2"	11-1/2"	10-1/2"	24	n/a
16"	13-1/8"	13-1/2"	12"	24	n/a
18"	14 3/8"	15"	12-3/4"	24	n/a
20"	16 3/8"	18"	14-7/8"	24	n/a
24"	19 3/8"	22"	18"	24	n/a

Endura-Stone™ columns are the first choice among builders and homeowners alike. These commercial-grade columns are perfect for both exterior and interior applications and feature historically accurate architectural designs and proportions. Manufactured from a non-porous material, Endura-Stone columns are impervious to natural elements like water, heat, cold, and even insects!

available in	column diameter	available column lengths	load bearing capacity
S/F/CF	6" 6"x6' 6"x8'		6,000 lbs
S/F/CF	8" 8"x6' 8"x8' 8"x9' 8"x10'		10,000 lbs
S/F/CF	10" 10"x6' 10"x8' 10"x9' 10"x10' 10"x12'		14,000 lbs
S/F/CF	12" 12"x6' 12"x8' 12"x9' 12"x10' 12"x12' 12"x14' 12"x16'		18,000 lbs
S/CF	14" 14"x6' 14"x8' 14"x9' 14"x10' 14"x12' 14"x14' 14"x16'		20,000 lbs
S/CF	16" 16"x6' 16"x8' 16"x9' 16"x10' 16"x12' 16"x14' 16"x16' 16"x18' 16"x20'		20,000 lbs
S/CF	18" 18"x6' 18"x8' 18"x9' 18"x10' 18"x12' 18"x14' 18"x16' 18"x18' 18"x20' 18"x22' 18"x24'		20,000 lbs
	20" 20"x6' 20"x8' 20"x9' 20"x10' 20"x12' 20"x14' 20"x16' 20"x18' 20"x20' 20"x22' 20"x24'		20,000 lbs
EC	22" 22"x6' 22"x8' 22"x9' 22"x10' 22"x12' 22"x14' 22"x16' 22"x18' 22"x20' 22"x22' 22"x24'		20,000 lbs
	24" 24"x6' 24"x8' 24"x9' 24"x10' 24"x12' 24"x14' 24"x16' 24"x18' 24"x20' 24"x22' 24"x24'		20,000 lbs
EC	30" 30"x6' 30"x8' 30"x9' 30"x10' 30"x12' 30"x14' 30"x16' 30"x18' 30"x20' 30"x22' 30"x24'		30,000 lbs
EC	36" 36"x6' 36"x8' 36"x9' 36"x10' 36"x12' 36"x14' 36"x16' 36"x18' 36"x20' 36"x22' 36"x24'		30,000 lbs

available in - S / smooth | F / fluted | CF / custom fluted | EC / Endura Classic

ENDURA-SERIES COLUMNS

Round Non-Tapered



ROUND NON-TAPERED / SHAFT AVAILABILITY

ENDURA-STONE™	column diameter	Available Column Lengths	load bearing capacity
S/CF	8"	8"x8' 8"x10'	10,000 lbs
S/CF	10"	10"x8' 10"x10'	14,000 lbs
S/CF	12"	12"x8' 12"x10' 12"x12'	18,000 lbs
S/CF	14"	14"x8' 14"x10' 14"x12' 14"x14'	20,000 lbs
S/CF	16"	16"x8' 16"x10' *16"x12' *16"x14' *16"x16' *16"x18' *16"x20' *16"x22'	20,000 lbs
S/CF	18"	18"x8' 18"x10' *18"x12' *18"x14' *18"x16' *18"x18' *18"x20' *18"x22'	20,000 lbs
S/CF	20"	20"x8' 20"x10' *20"x12' *20"x14' *20"x16' *20"x18' *20"x20' *20"x22' *20"x24'	20,000 lbs
S/CF	22"	22"x8' *22"x10' *22"x12' *22"x14' *22"x16' *22"x18' *22"x20' *22"x22'	20,000 lbs
S/CF	24"	24"x8' 24"x10' 24"x12' *24"x14' *24"x16' *24"x18' *24"x20' *24"x22' *24"x24'	20,000 lbs
S/CF	28"	28"x8' *28"x10' *28"x12' *28"x14' *28"x16' *28"x18' 28"x20' 28"x22' 28"x24'	20,000 lbs
S/CF	30"	30"x8' *30"x10' *30"x12' *30"x14' *30"x16' *30"x18' 30"x20' 30"x22' 30"x24'	30,000 lbs
S/CF	36"	26"x8' *36"x10' *36"x12' *36"x14' *36"x16' *36"x18' 36"x20' 36"x22' 36"x24'	30,000 lbs

available in - S / smooth | CF / custom fluted
height can be adjusted to exact dimensions

* = Endura-Classic

ENDURA-STONE™ ROUND NON-TAPERED TUSCAN CAPITAL

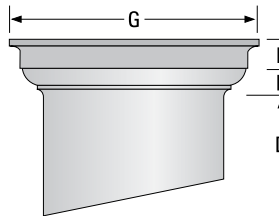

column diameter	round				total
	E	F	G	E-F	
8"	1-5/16"	1-3/18"	9-7/8"	2-11/16"	
10"	1-13/16"	1-3/4"	12-1/8"	3-9/16"	
12"	1-7/8"	2"	14-5/8"	3-7/8"	
14"	2-1/2"	2-5/16"	17"	4-15/16"	

ENDURA-STONE™ ROUND NON-TAPERED TUSCAN BASE

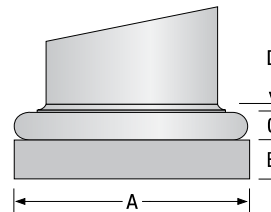

column diameter	plinth		base moulding		total
	A	B	C	D	
8"	10-7/8"	1-7/8"	1-3/4"	5/8"	4-1/4"
10"	13-1/2"	2-3/8"	2-1/8"	3/4"	5-1/4"
12"	16-1/4"	2-3/4"	2-3/8"	7/8"	6"
14"	18-5/8"	3-5/16"	3"	1"	7-5/16"

ENDURA-STONE™ ROUND NON-TAPERED SHAFT SPECIFICATIONS



outside diameter		inside diameter	
bottom	top	bottom	top
8"	8"	6-3/4"	6-3/4"
10"	10"	8-3/8"	8-3/8"
12"	12"	10-3/4"	10-3/4"
14"	14"	11-1/2"	1-1/2"

please visit www.pacificcolumns.com for more specifications

ENDURA-STONE™ ROUND NON-TAPERED ATTIC BASE

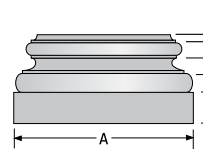

column diameter	plinth			base moulding			total
	A	B	C	D	E	F	
8"	10-7/8"	1-7/8"	1-1/8"	7/8"	3/4"	1/2"	5-1/8"
10"	13-1/2"	2-3/8"	1-1/4"	1-1/8"	7/8"	5/8"	6-1/4"
12"	16-1/8"	2-3/4"	1-1/2"	1-3/8"	1"	5/8"	7-1/4"
14"	18-1/2"	3-5/16"	1-3/4"	1-5/8"	1-1/4"	11/16"	8-5/8"

IN A T I O N W I D E
QUICKSHIP

as quick as same day shipping

ENDURA-STONE COLUMNS

Square Non-Tapered

NEW



SHAFT SPECIFICATIONS

outside diameter		inside diameter	fluting specifications		
bottom	top	square	number	width	
6"	6"	4' 3/4"	5/side	2"	
8"	8"	6' 3/4"	5/side	1"	
10"	10"	8' 3/4"	5/side	7/8"	
12"	12"	10' 3/4"	5/side	1"	
14"	14"	12' 1/2"	5/side	1' 1/4"	

SHAFT

column diameter	available column lengths						concentric load limits
6"	6"x8'	6"x9'	6"x10'			6,000 lbs	
	S/AF	S/AF	S/AF				
8"	8"x8'	8"x9'	8"x10'		10,000 lbs		
	S/F/AF/P/M	S/F/AF/P/M	S/F/AF/P/M				
	S/AF/M	S/AF/M	S/AF/M				
10"	10"x8'	10"x9'	10"x10'	10"x12'		12,800 lbs	
	S/AF/M	S/AF/M	S/AF/M	S/AF			
12"	12"x8'	12"x9'	12"x10'	12"x12'	12"x14'	12"x16'	18,000 lbs
	S/AF	S/AF	S/AF	S/AF	S/AF	S/AF	
	S/AF	S/AF	S/AF	S/AF	S/AF	S/AF	
14"	14"x8'	14"x9'	14"x10'	14"x12'	14"x14'	14"x16'	20,000 lbs
	S/AF	S/AF	S/AF	S/AF	S/AF	S/AF	

available in - S / smooth | F / fluted | CF / custom flute | P / Paneled | M / Recessed Panel

TUSCAN CAPITAL

column diameter	round			abacus		total
	E	F	G	H	I	G-H
6"	1"	1-1/16"	8-7/16"	1-1/16"	7-1/2"	2-1/32"
8"	1-5/16"	1-7/16"	11-1/4"	1-3/8"	11-1/4"	2-11/16"
10"	1-13/16"	1-3/4"	13-1/4"	1-3/4"	13-7/32"	3-9/16"
12"	1-7/8"	2"	17-1/4"	2"	17-1/4"	3-7/8"
14"	2-1/2"	2-5/16"	18-11/16"	2-5/16"	18-11/16"	4-13/16"

TUSCAN BASE

column diameter	plinth	base moulding			total
	A	B	C	D	B-D
6"	8"	1-1/2"	1-1/4"	15/32"	3-7/32"
8"	11-3/8"	1-7/8"	1-3/4"	5/8"	4-1/4"
10"	13-1/2"	2-3/8"	2-1/8"	3/4"	5-1/4"
12"	17"	2-3/4"	2-3/8"	7/8"	6"
14"	18-13/16"	3-3/8"	2-5/16"	1-1/16"	7-3/8"

PEDESTAL BASE

for use with	base square	height
8" square column	15"x15"	42-1/2"

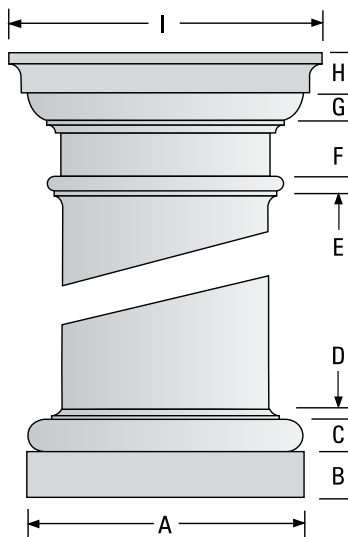



ENDURA-STONE

LOAD BEARING
6,000-30,000 LBS

HEIGHT
6' TO 24'

DIAMETER
6" TO 24"



ALL ENDURA-STONE COLUMNS AVAILABLE IN THESE COLORS

MAINTENANCE FREE



SMOOTH OR FLUTED SHAFT



ROUND OR SQUARE COLUMNS



LIFETIME WARRANTY



COLOR THROUGHOUT



NO PAINTING

IN A T I O N W I D E
Q U I C K S H I P

as quick as same day shipping



Square Tapered Column Wrap

SQUARE TAPERED EDURA-CRAFT SHAFT & PANEL SPECIFICATIONS



column width	available column lengths				shaft specifications			
					column bottom		column top	
					nominal width	net width	nominal width	net width
12"	12"x4'	12"x5'	12"x6'	12"x8'	12"	11-5/8"	8"	7-5/8"
16"	16"x4'	16"x5'	16"x6'	16"x8'	16"	15-5/8"	12"	11-5/8"
20"	20"x4'	20"x5'	20"x6'	20"x8'	20"	19-5/8"	14"	13-5/8"
24"	24"x4'	24"x5'	24"x6'	24"x8'	24"	23-5/8"	16"	15-5/8"

WE CAN DO ANY SIZE

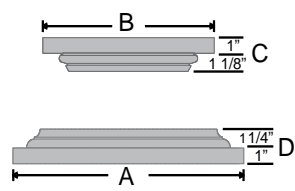

STANDARD CAPITAL & BASE

column width	base specifications		capital specifications	
	A	D	B	C
12"	15-5/8"	1 1/4"	11-5/8"	2 1/8"
16"	19-5/8"	1 1/4"	15-5/8"	2 1/8"
20"	23-5/8"	1 1/4"	17-5/8"	2 1/8"
24"	27-5/8"	1 1/4"	19-5/8"	2 1/8"

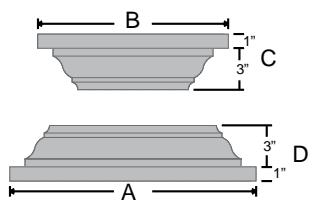

OPTIONAL CROWN CAPITAL & BASE

column width	base specifications		capital specifications	
	A	D	B	C
12"	17-5/8"	4"	13-5/8"	4"
16"	21-5/8"	4"	17-5/8"	4"
20"	25-5/8"	4"	19-5/8"	4"
24"	29-5/8"	4"	21-5/8"	4"

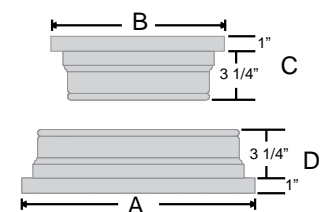

OPTIONAL PRAIRIE CAPITAL & BASE

column width	base specifications		capital specifications	
	A	D	B	C
12"	15-5/8"	4-1/4"	11-5/8"	4-1/4"
16"	19-5/8"	4-1/4"	15-5/8"	4-1/4"
20"	23-5/8"	4-1/4"	17-5/8"	4-1/4"
24"	27-5/8"	4-1/4"	19-5/8"	4-1/4"

ENDURA-CRAFT COLUMNS

Square Non-Tapered Column Wrap



SQUARE NON-TAPERED ENDURA-CRAFT SHAFT AVAILABILITY & PANEL

column width	available column lengths					shaft specifications		
	6"x4'	6"x5'	6"x6'	6"x8'	6"x10'	nominal width	net width	inside diameter
6"	6"x4' S/F	6"x5' S/F	6"x6' S/F	6"x8' S/F	6"x10' S/F	6"	5-5/8"	4-5/8"
8"	8"x4' S/F/P	8"x5' S/F/P	8"x6' S/F/P	8"x8' S/F/P	8"x10' S/F/P/M	8"	7-7/8"	6-7/8"
10"	10"x4' S/F/P	10"x5' S/F/P	10"x6' S/F/P	10"x8' S/F/P	10"x10' S/F/P/M	10"	9-5/8"	8-3/8"
12"	12"x4' S/F/P	12"x5' S/F/P	12"x6' S/F/P	12"x8' S/F/P	12"x10' S/F/P/M	12"	11-5/8"	10-3/8"

WE CAN DO ANY SIZE

Custom Sizes Available



Quick Installation



Available for QuickShip



Lifetime Warranty



Perfect for Wrapping Posts



Water Proof



Insect Resistant



Low-Price Guarantee



Multiple Shaft, Cap, and Base Options

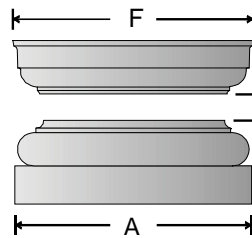

TUSCAN CAPITAL & BASE

column width	base specifications		capital specifications	
	A	B-C	F	E-D
6"	8-1/16"	3-1/4"	8-7/16"	2-1/16"
8"	10-7/8"	4-1/4"	11-1/4"	3-1/8"
10"	13-1/2"	5-1/4"	13-7/32"	3-9/16"
12"	17"	6"	17-1/4"	3-7/8"

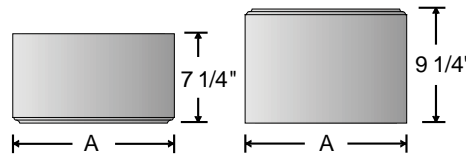

STANDARD CAPITAL & BASE

outside width	cap/base width A	cap height B	base height C
6"	6-7/8"	7-1/4"	9-1/4"
8"	8-7/8"	7-1/4"	9-1/4"
10"	10-7/8"	7-1/4"	9-1/4"
12"	12-7/8"	7-1/4"	9-1/4"

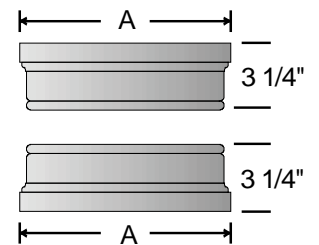

PRAIRIE CAPITAL & BASE

outside width	cap/base width A	cap height	base height
6"	8-1/8"	3-1/4"	3-1/4"
8"	10-1/8"	3-1/4"	3-1/4"
10"	12-1/8"	3-1/4"	3-1/4"
12"	14-1/8"	3-1/4"	3-1/4"

PRECISION MITER JOINTS

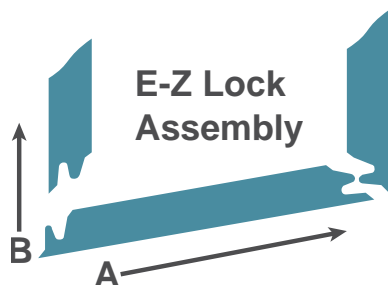

AVAILABLE PANEL STYLES



PLAIN



FLUTED



RECESSED PANEL



RAISED PANEL



"SQUARE CORNER"
RAISED PANEL

ENDURA-CRAFT COLUMNS

ENDURA-CRAFT INSTALLATION OVERVIEW

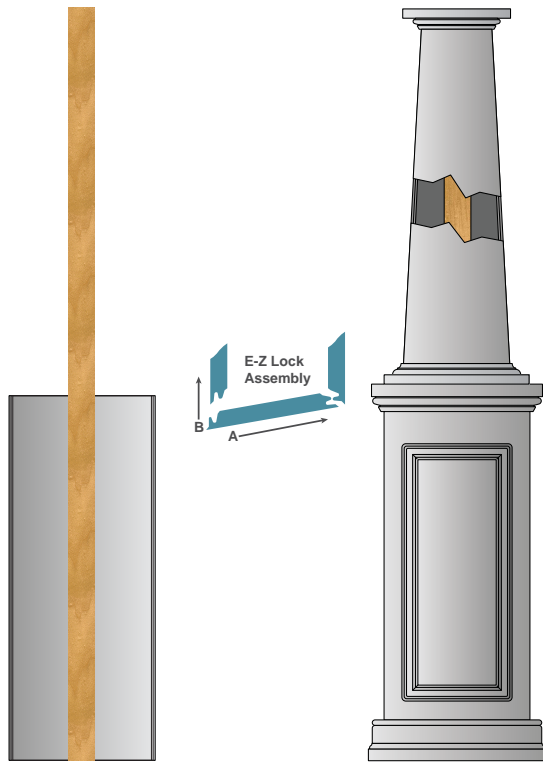

PEDESTALS OVERVIEW

AVAILABLE HEIGHTS FROM 32" TO 60"

nominal width	outside width	inside width
6"	5-5/8"	4-5/8"
8"	7-5/8"	6-5/8"
10"	9-5/8"	8-5/8"
12"	11-5/8"	10-5/8"
14"	13-5/8"	12-5/8"
16"	15-5/8"	14-5/8"
18"	17-5/8"	16-5/8"
20"	19-5/8"	18-5/8"
22"	21-5/8"	20-5/8"
24"	23-5/8"	22-5/8"
26"	25-5/8"	26-5/8"
28"	27-5/8"	26-5/8"
30"	29-5/8"	28-5/8"



ENDURA-CRAFT MIX-N-MATCH EXAMPLES

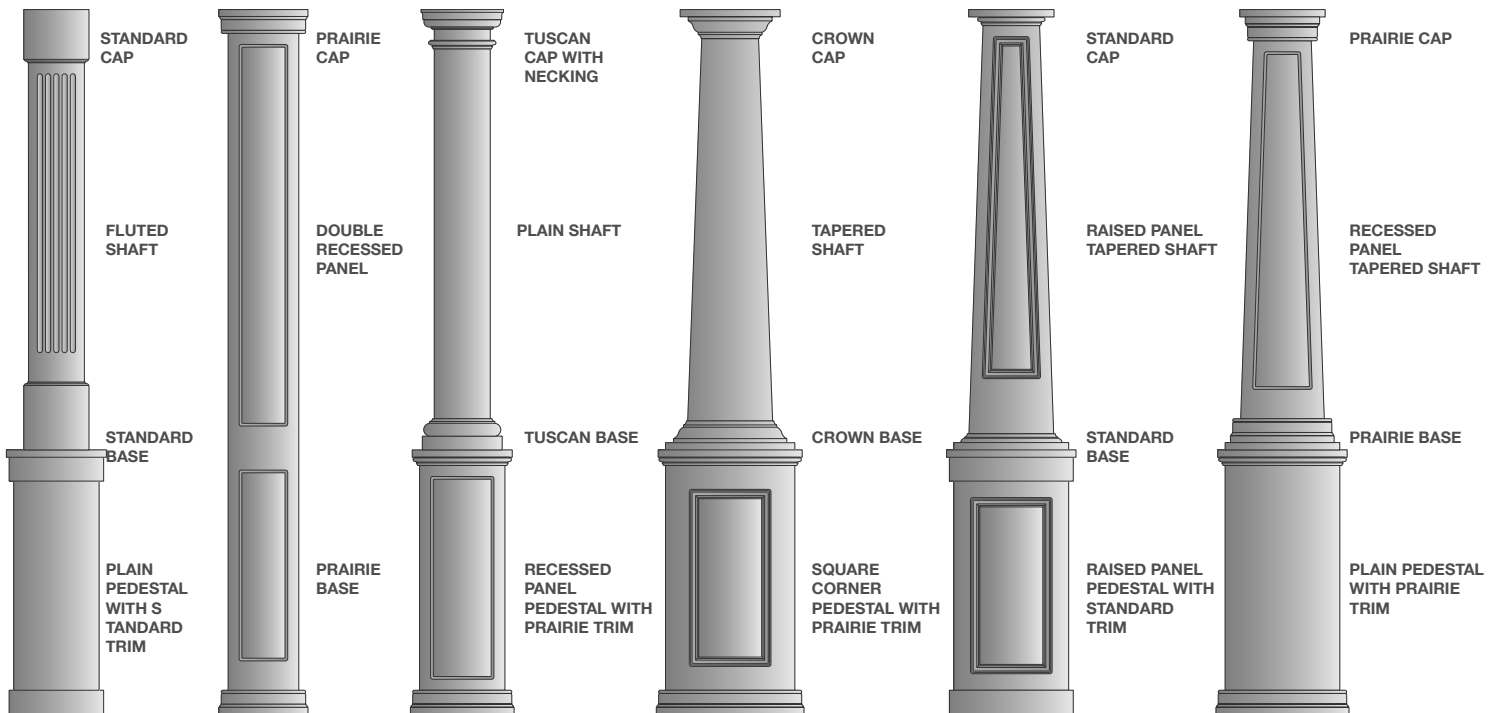

ENDURA-SERIES

INSTALLATION OVERVIEW

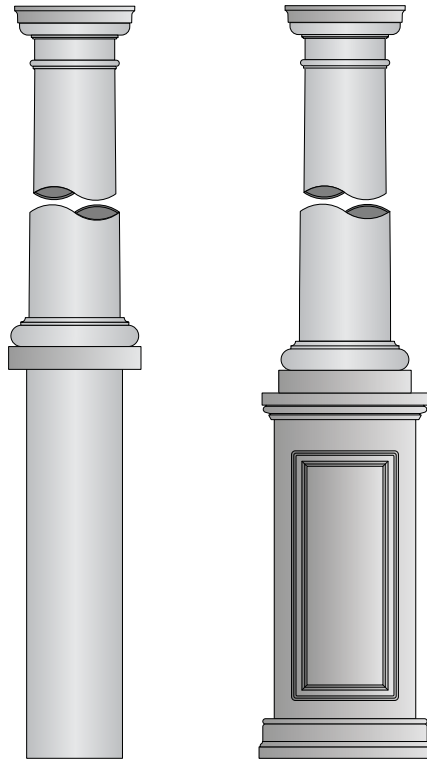

Use Endura-Craft pedestal bases with our Endura-Stone, round columns! Simply install the Endura Stone column as you normally would, and then assemble the Endura-Craft Pedestal base around it.

- Endura-Stone is load-bearing
- Install pedestal bases around existing round columns
- Simple installation
- High-end custom carpentry appearance
- Historically accurate
- Virtually unlimited design options

ENDURA-SERIES

MIX-N-MATCH EXAMPLES

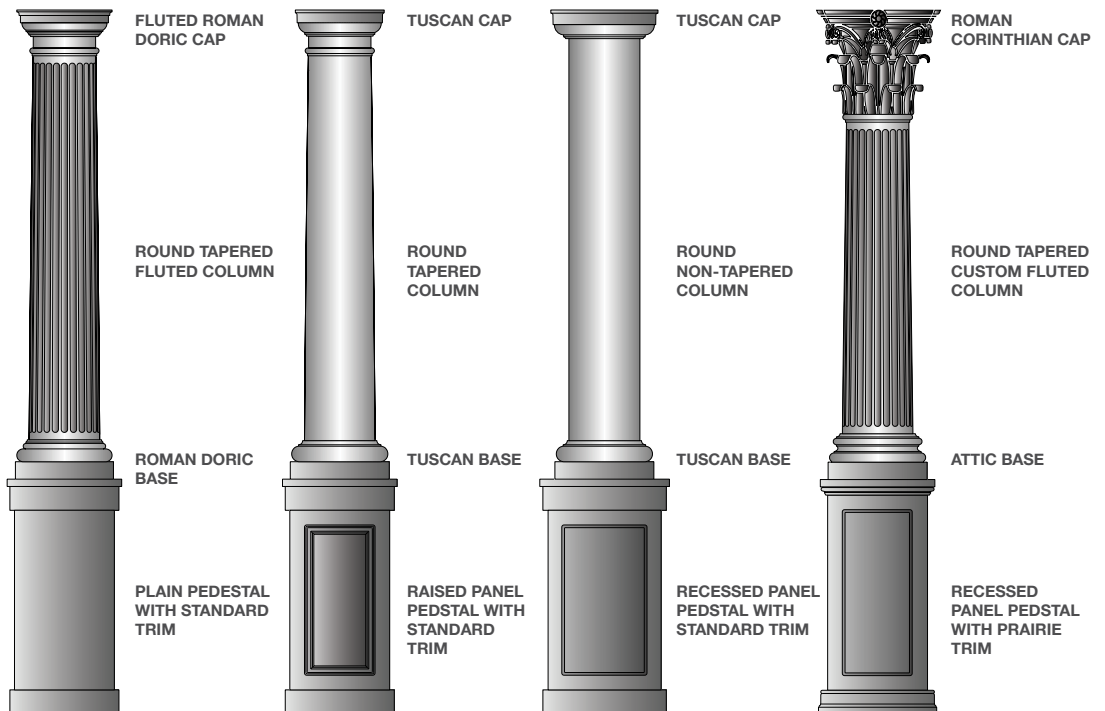

WOOD COLUMNS

HEIGHTS 2' to 36'

OUTSIDE DIAMETER

bottom top

6"	4-3/4"
8"	6-1/2"
10"	8-1/2"
12"	10"
14"	12"
15"	12-3/4"
16"	13-1/2"
18"	15"
20"	17"
22"	18-1/2"
24"	20"
26"	22"
28"	23-1/2"
30"	25"
32"	27"
34"	28-1/2"
36"	30"

sizes can be adjusted

GREEK DORIC

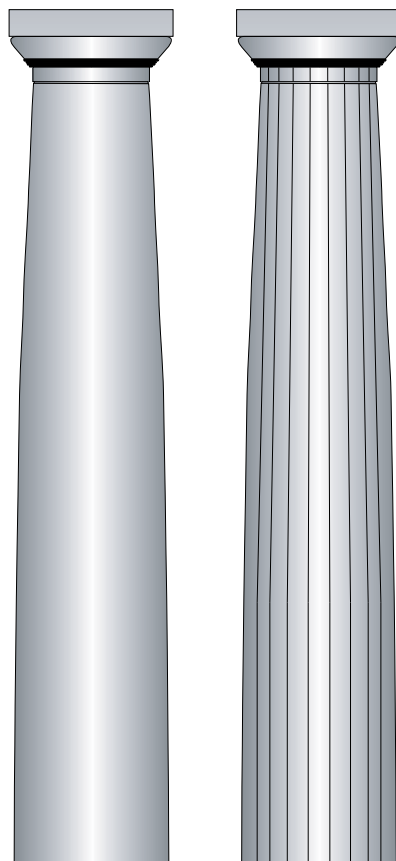

TUSCAN

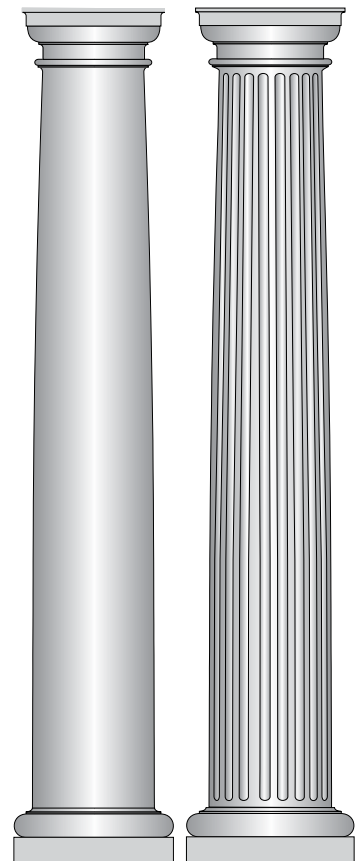

ARCHITECTURAL WOOD COLUMNS

Premiere Series™

Wood Columns embody the beauty and elegance of their classical predecessors, as well as unique, contemporary forms. Now you can incorporate their timeless appeal into both exterior and interior spaces. We offer a diverse selection of wood columns to meet all your decorative needs. Our wood columns encompass historically accurate styles, including the basic Doric, elegant Ionic and richly textured Corinthian orders. If you want something custom, we can mill any desired wood species into virtually any diameter, height, and shape that will work perfect for your project.

Excellent Craftsmanship



Precision Wood Turning



Historically Accurate Specifications



Unlimited Custom Designs Available



Manufactured in any Wood Species



Both Stain-Grade and Paint-Grade Available



Hand-Carved Solid Wood Capitals

WOOD SPECIES AVAILABLE

PINE

MAPLE

ALDER

OAK

CHERRY

MAHOGANY

WALNUT

& MORE

ROMAN DORIC

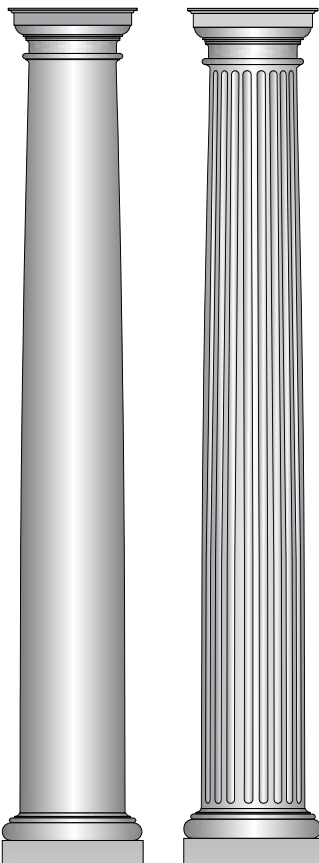

IONIC

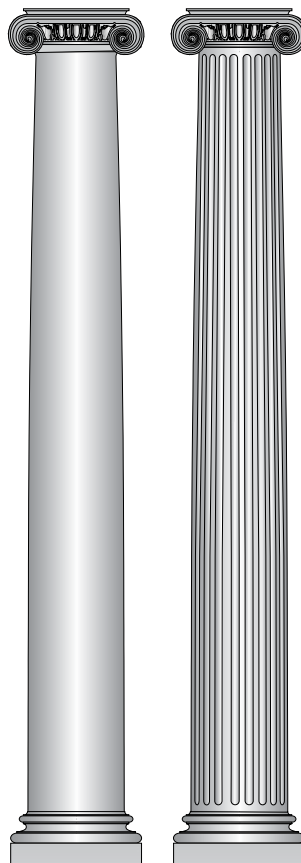

CORINTHIAN

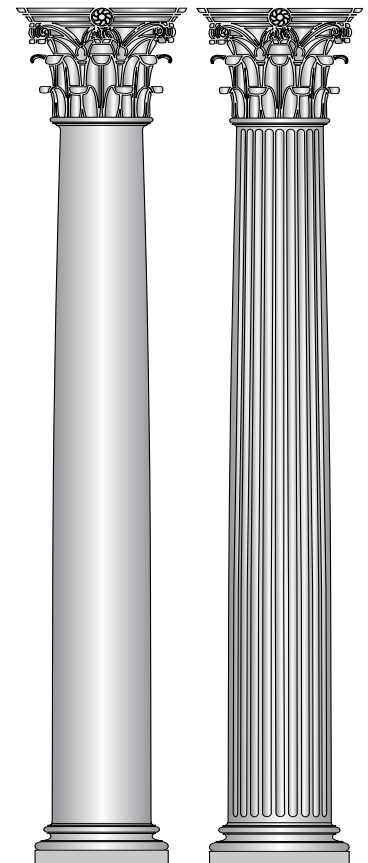

ENDURA-LUM COLUMNS



ACADIAN CRAFTSMAN EMPIRE WELLINGTON

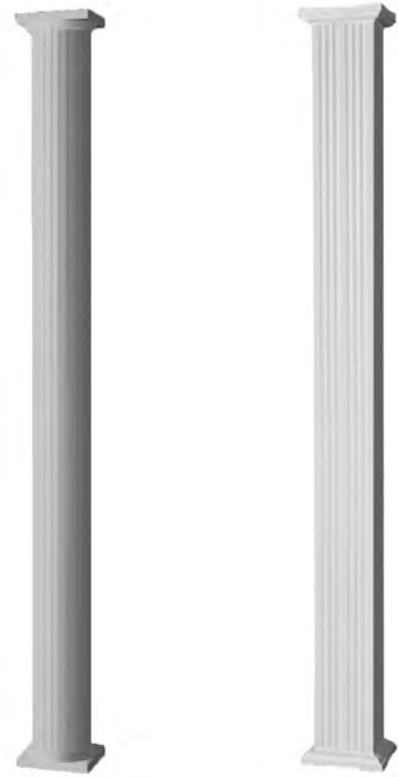

ROUND FLUTED SQUARE FLUTED

ROUND FLUTED

normal size	standard lengths	dimensions			max load bearing
		a	b	c	
3"	8', 9'	3"	N/A	N/A	8,000 lbs
4"	8', 9', 10'	3-1/2"	5-5/8"	1-7/8"	12,000 lbs
6"	8', 9', 10'	5-1/2"	8-1/2"	2"	23,000 lbs
8"	8', 9', 10', 12'	7-1/2"	10-1/2"	2"	24,000 lbs
10"	8', 10', 12', 16', 18', 20'	10"	12-7/8"	2-11/16"	26,000 lbs
12"	8', 9', 10', 12', 16', 18', 20'	11-15/16"	15-1/8"	3-3/16"	37,000 lbs



SQUARE FLUTED

normal size	standard lengths	dimensions			max load bearing
		a	b	c	
6"	8', 9', 10'	6"	7-9/16"	1-3/4"	20,000 lbs
8"	8', 9', 10', 12', 16', 18', 20'	7-5/8"	9-7/16"	2-3/16"	21,000 lbs
10"	8', 9', 10', 12', 16', 18', 20'	9-3/8"	11-1/4"	2-3/8"	26,000 lbs
12"	8', 9', 10', 12', 16', 18', 20'	11-1/2"	15-1/8"	2-3/4"	37,000 lbs
15"	8', 9', 10', 12', 16', 18', 20', 24'	14-1/2"	18-3/4"	4-3/4"	45,000 lbs
18"	12', 16', 18', 20', 24'	17-3/4"	22-1/2"	5"	45,000 lbs
24"	18', 20', 24'	24-1/2"	28-7/8"	7-3/4"	45,000 lbs



DIAMETERS FROM 3" TO 24"



HEIGHTS FROM 2' TO 24'



PROTECTIVE POWDER COAT FINISH



SHIPS WITHIN 72 HOURS



LOAD BEARING 8,000 LBS TO 50,000 LBS

EMPIRE

normal size	standard lengths	dimensions			max load bearing
		a	b	c	
6"	8', 9', 10'	5-1/2"	8-1/2"	3-1/2"	12,000 lbs
8"	8', 9', 10', 12'	7-1/4"	9-7/8"	3-1/2"	20,000 lbs
9"	8', 9', 10', 12'	9"	11-11/16"	3-1/2"	15,000 lbs



CRAFTSMAN

normal size	standard lengths	dimensions			max load bearing
		a	b	c	
6"	8', 9', 10'	5-1/2"	6-3/4"	2-1/2"	20,000 lbs



ACADIAN

normal size	standard lengths	dimensions			max load bearing
		a	b	c	
6"	8', 9', 10', 12'	5-1/2"	8-1/2"	2"	24,000 lbs
8"	8', 9', 10', 12'	7-1/2"	10-1/2"	2"	50,000 lbs



WELLINGTON

normal size	standard lengths	dimensions			max load bearing
		a	b	c	
6"	8', 9', 10'	5-1/2"	8-1/2"	3-1/2"	12,000 lbs
8"	8', 9', 10', 12'	7-1/4"	9-7/8"	3-1/2"	20,000 lbs
9"	8', 9', 10', 12'	9"	11-11/16"	3-1/2"	15,000 lbs

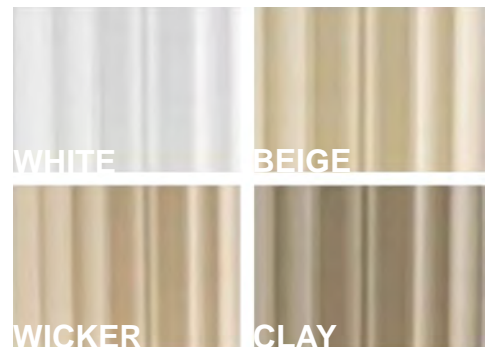

COLUMN SAMPLES



ENDURA-LUM SAMPLE



ENDURA-STONE SAMPLE

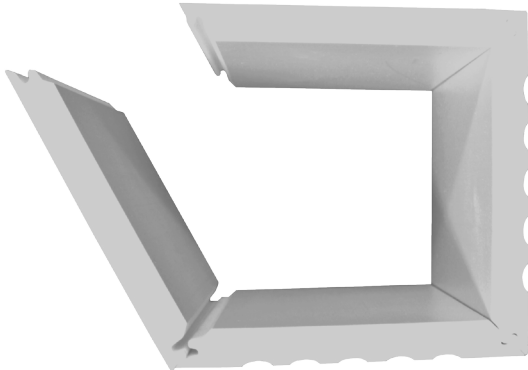

ENDURA-CRAFT SAMPLE



WOOD SAMPLE

BALUSTRADE



THE *BEST* REASONS TO CHOOSE FIBERTHANE BALUSTRADE

The entire FiberThane system was designed from the ground up, utilizing state-of-the-art materials for each component. Constructed from pultruded fiberglass, the rails and newel posts are made with some of the strongest and most durable construction materials available. Our balusters are made out of a structural aluminum alloy surrounded by molded polyurethane, giving you the strength of structural metal, and the architectural design and crisp detail of urethane.

Why choose the FIBERTHANE® balustrade systems:

- Fiberglass top and bottom rails are more durable than any other material in the market.
- Is light-weight (between 15lbs - 22lbs per foot), making it perfect for every application.
- Can span 16' lengths while still passing construction codes.
- Rails are sold in one-foot increments. This means no wasted rail.
- Patent Pending 'Quick-Install' brackets are concealed and provide a completely finished look.
- The 'Quick-Install' brackets allow for quicker installation than traditional methods.
- Over 100 different baluster designs – balusters available with either round or square blocks.
- Easiest stair installation you have ever seen. Ask us, we will explain.
- Maintenance free. Impervious to weather, moisture, and insects. Will not crack, chip, or deteriorate.
- Lifetime warranty.
- All spindles, rails, and newels are 100% unique designs.
- Pre-drilled holes or even full length pre-assembled sections are available.
- Available to ship within 72 hours. Need it faster? Tell us, and we will ship tomorrow!
- More cost-effective than Urethane or FRP systems.

SPINDLE OPTIONS

TOP BLOCK

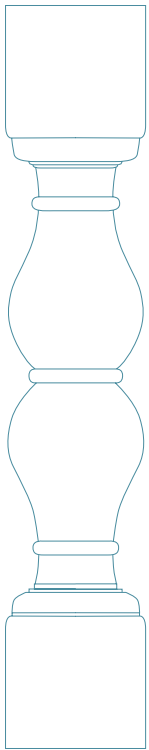

BOTTOM BLOCK

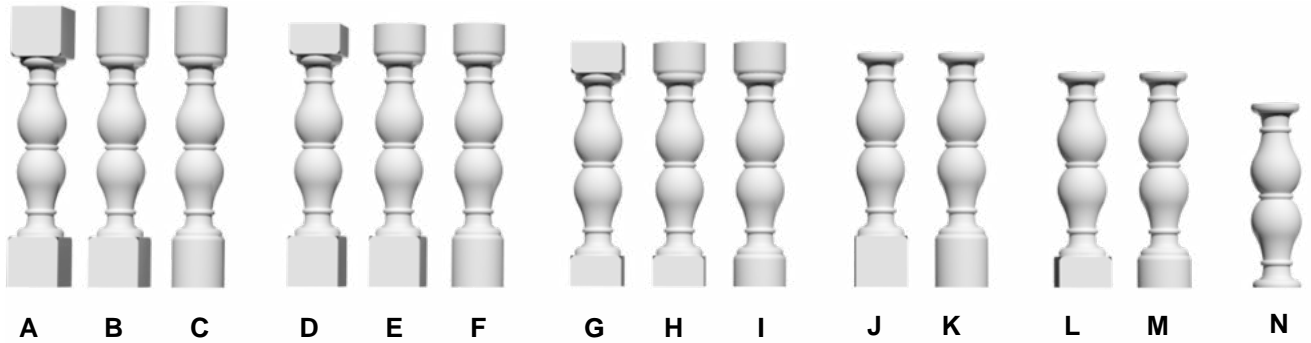

AVALON BALUSTRADE SYSTEM

	Part Number	Spindle Width	Top Block Height	Bottom Block Height	Spindle Height	On Center Spacing	Spindles per Foot	*Overall System Height
A	BAL05X28AV-A	5"	5" Sq	5" Sq	28"	6-7/8"	1.75	42-1/2"
B	BAL05X28AV-B	5"	5" Rd	5" Sq	28"	6-7/8"	1.75	42-1/2"
C	BAL05X28AV-C	5"	5" Rd	5" Rd	28"	6-7/8"	1.75	42-1/2"
D	BAL05X26AV-D	5"	3" Sq	5" Sq	26"	6-7/8"	1.75	40-1/2"
E	BAL05X26AV-E	5"	3" Rd	5" Sq	26"	6-7/8"	1.75	40-1/2"
F	BAL05X26AV-F	5"	3" Rd	5" Rd	26"	6-7/8"	1.75	40-1/2"
G	BAL05X24AV-G	5"	3" Sq	3" Sq	24"	6-7/8"	1.75	38-1/2"
H	BAL05X24AV-H	5"	3" Rd	3" Sq	24"	6-7/8"	1.75	38-1/2"
I	BAL05X24AV-I	5"	3" Rd	3" Rd	24"	6-7/8"	1.75	38-1/2"
J	BAL05X23AV-J	5"	None	5" Sq	23"	6-7/8"	1.75	37-1/2"
K	BAL05X23AV-K	5"	None	5" Rd	23"	6-7/8"	1.75	37-1/2"
L	BAL05X21AV-L	5"	None	3" Sq	21"	6-7/8"	1.75	35-1/2"
M	BAL05X21AV-M	5"	None	3" Rd	21"	6-7/8"	1.75	35-1/2"
N	BAL05X18AV-N	5"	None	None	18"	6-7/8"	1.75	32-1/2"

*Overall System Height includes 3 7/8" space below rail, bottom rail, top rail, and baluster height
 **Estimated Price Per Foot includes top and bottom rails and balusters space to pass 4" sphere code

SPINDLE OPTIONS

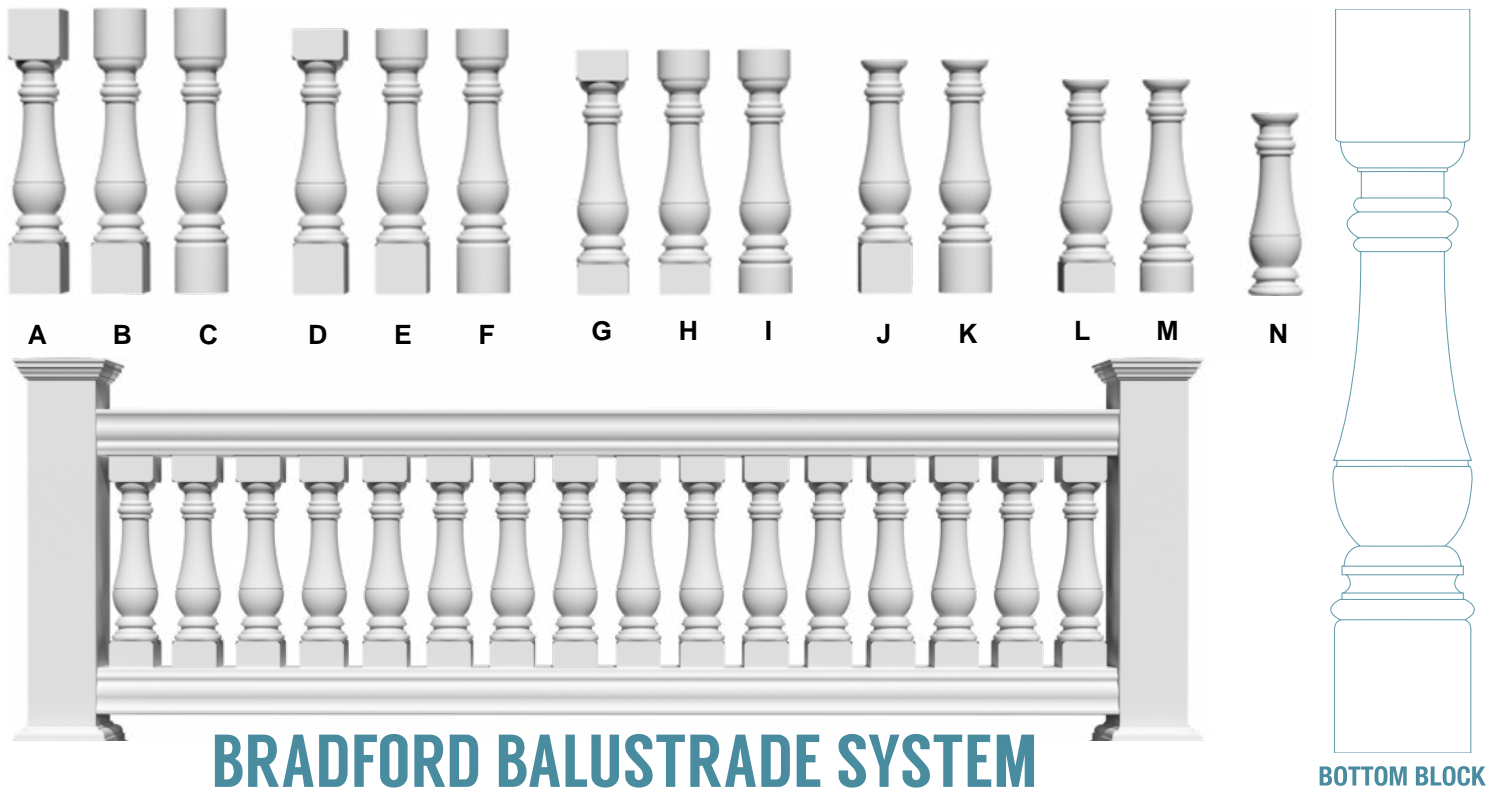

BRADFORD BALUSTRADE SYSTEM

	Part Number	Spindle Width	Top Block Height	Bottom Block Height	Spindle Height	On Center Spacing	Spindles per Foot	*Overall System Height
A	BAL05X28BR-A	5"	5" Sq	5" Sq	28"	6-7/8"	1.75	42-1/2"
B	BAL05X28BR-B	5"	5" Rd	5" Sq	28"	6-7/8"	1.75	42-1/2"
C	BAL05X28BR-C	5"	5" Rd	5" Rd	28"	6-7/8"	1.75	42-1/2"
D	BAL05X26BR-D	5"	3" Sq	5" Sq	26"	6-7/8"	1.75	40-1/2"
E	BAL05X26BR-E	5"	3" Rd	5" Sq	26"	6-7/8"	1.75	40-1/2"
F	BAL05X26BR-F	5"	3" Rd	5" Rd	26"	6-7/8"	1.75	40-1/2"
G	BAL05X24BR-G	5"	3" Sq	3" Sq	24"	6-7/8"	1.75	38-1/2"
H	BAL05X24BR-H	5"	3" Rd	3" Sq	24"	6-7/8"	1.75	38-1/2"
I	BAL05X24BR-I	5"	3" Rd	3" Rd	24"	6-7/8"	1.75	38-1/2"
J	BAL05X23BR-J	5"	None	5" Sq	23"	6-7/8"	1.75	37-1/2"
K	BAL05X23BR-K	5"	None	5" Rd	23"	6-7/8"	1.75	37-1/2"
L	BAL05X21BR-L	5"	None	3" Sq	21"	6-7/8"	1.75	35-1/2"
M	BAL05X21BR-M	5"	None	3" Rd	21"	6-7/8"	1.75	35-1/2"
N	BAL05X18BR-N	5"	None	None	18"	6-7/8"	1.75	32-1/2"

*Overall System Height includes 3 7/8" space below rail, bottom rail, top rail, and baluster height
 **Estimated Price Per Foot includes top and bottom rails and balusters space to pass 4" sphere code

SPINDLE OPTIONS

TOP BLOCK

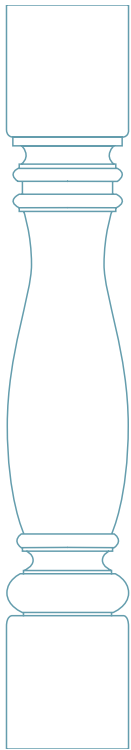

BOTTOM BLOCK

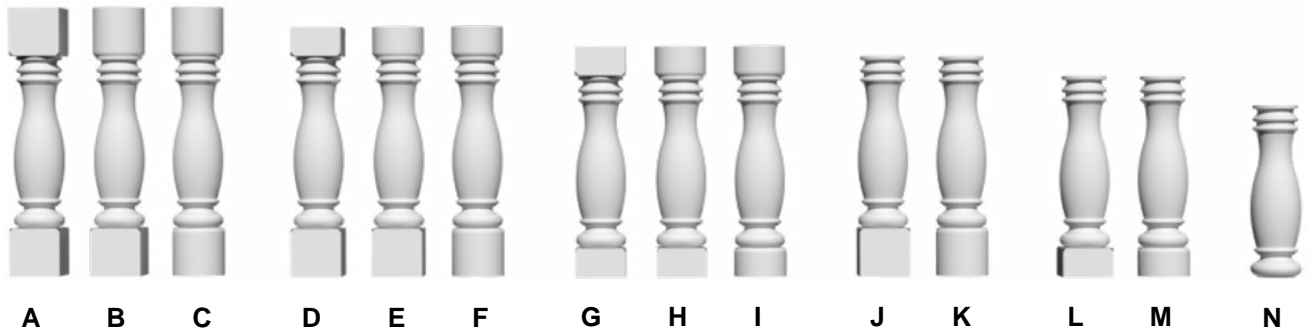

EMBASSY BALUSTRADE SYSTEM

	Part Number	Spindle Width	Top Block Height	Bottom Block Height	Spindle Height	On Center Spacing	Spindles per Foot	*Overall System Height
A	BAL05X28EM-A	5"	5" Sq	5" Sq	28"	7"	1.71	42-1/2"
B	BAL05X28EM-B	5"	5" Rd	5" Sq	28"	7"	1.71	42-1/2"
C	BAL05X28EM-C	5"	5" Rd	5" Rd	28"	7"	1.71	42-1/2"
D	BAL05X26EM-D	5"	3" Sq	5" Sq	26"	7"	1.71	40-1/2"
E	BAL05X26EM-E	5"	3" Rd	5" Sq	26"	7"	1.71	40-1/2"
F	BAL05X26EM-F	5"	3" Rd	5" Rd	26"	7"	1.71	40-1/2"
G	BAL05X24EM-G	5"	3" Sq	3" Sq	24"	7"	1.71	38-1/2"
H	BAL05X24EM-H	5"	3" Rd	3" Sq	24"	7"	1.71	38-1/2"
I	BAL05X24EM-I	5"	3" Rd	3" Rd	24"	7"	1.71	38-1/2"
J	BAL05X23EM-J	5"	None	5" Sq	23"	7"	1.71	37-1/2"
K	BAL05X23EM-K	5"	None	5" Rd	23"	7"	1.71	37-1/2"
L	BAL05X21EM-L	5"	None	3" Sq	21"	7"	1.71	35-1/2"
M	BAL05X21EM-M	5"	None	3" Rd	21"	7"	1.71	35-1/2"
N	BAL05X18EM-N	5"	None	None	18"	7"	1.71	32-1/2"

*Overall System Height includes 3 7/8" space below rail, bottom rail, top rail, and baluster height

**Estimated Price Per Foot includes top and bottom rails and balusters space to pass 4" sphere code

SPINDLE OPTIONS

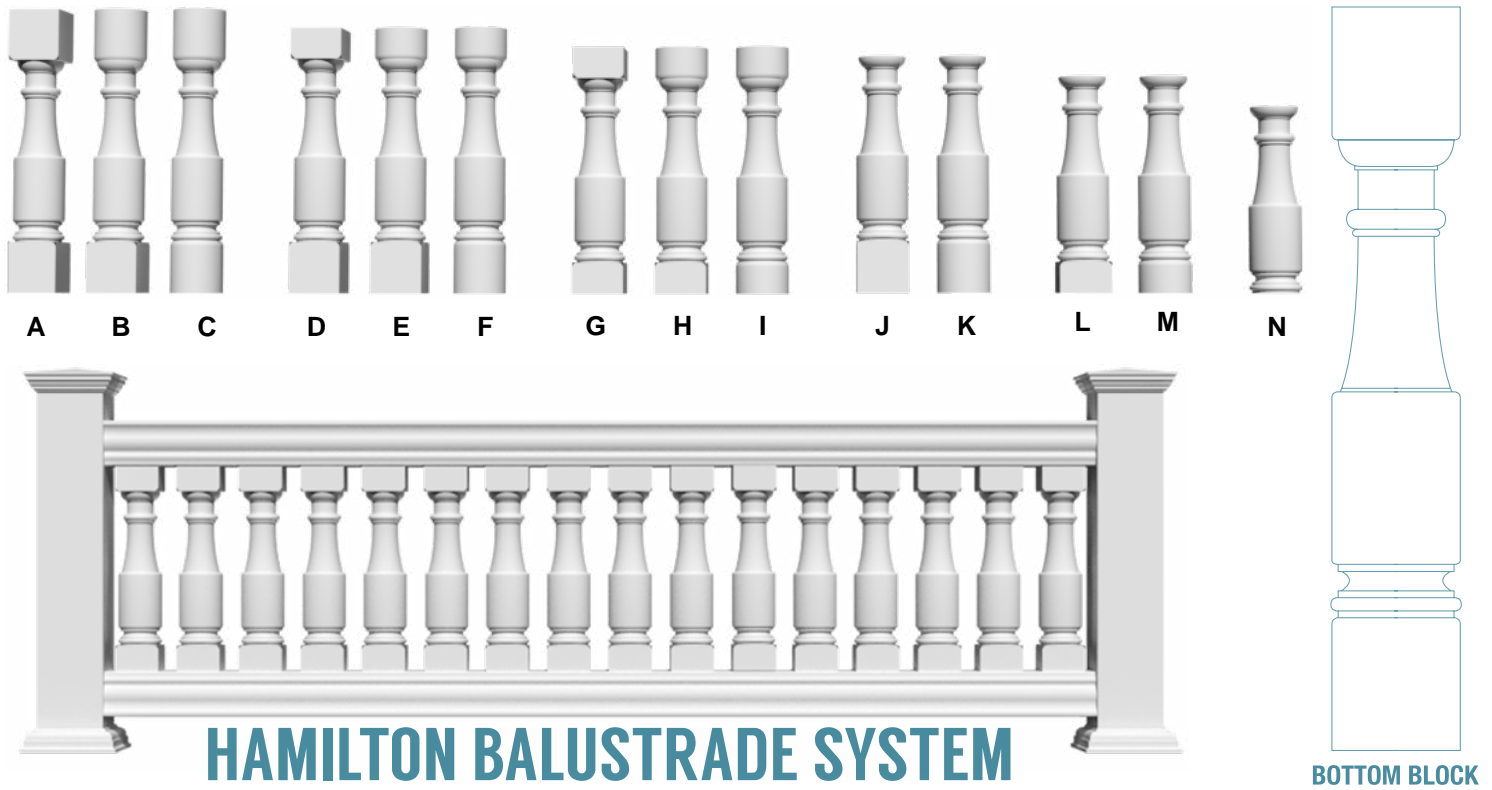

HAMILTON BALUSTRADE SYSTEM

Part Number	Spindle Width	Top Block Height	Bottom Block Height	Spindle Height	On Center Spacing	Spindles per Foot	*Overall System Height	
A	BAL05X28HM-A	5"	5" Sq	5" Sq	28"	6-7/8"	1.75	42-1/2"
B	BAL05X28HM-B	5"	5" Rd	5" Sq	28"	6-7/8"	1.75	42-1/2"
C	BAL05X28HM-C	5"	5" Rd	5" Rd	28"	6-7/8"	1.75	42-1/2"
D	BAL05X26HM-D	5"	3" Sq	5" Sq	26"	6-7/8"	1.75	40-1/2"
E	BAL05X26HM-E	5"	3" Rd	5" Sq	26"	6-7/8"	1.75	40-1/2"
F	BAL05X26HM-F	5"	3" Rd	5" Rd	26"	6-7/8"	1.75	40-1/2"
G	BAL05X24HM-G	5"	3" Sq	3" Sq	24"	6-7/8"	1.75	38-1/2"
H	BAL05X24HM-H	5"	3" Rd	3" Sq	24"	6-7/8"	1.75	38-1/2"
I	BAL05X24HM-I	5"	3" Rd	3" Rd	24"	6-7/8"	1.75	38-1/2"
J	BAL05X23HM-J	5"	None	5" Sq	23"	6-7/8"	1.75	37-1/2"
K	BAL05X23HM-K	5"	None	5" Rd	23"	6-7/8"	1.75	37-1/2"
L	BAL05X21HM-L	5"	None	3" Sq	21"	6-7/8"	1.75	35-1/2"
M	BAL05X21HM-M	5"	None	3" Rd	21"	6-7/8"	1.75	35-1/2"
N	BAL05X18HM-N	5"	None	None	18"	6-7/8"	1.75	32-1/2"

Overall System Height includes 3 7/8" space below rail, bottom rail, top rail, and baluster height
 Estimated Price Per Foot includes top and bottom rails and balusters space to pass 4" sphere code

SPINDLE OPTIONS

TOP BLOCK

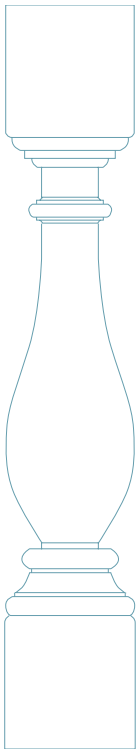

BOTTOM BLOCK

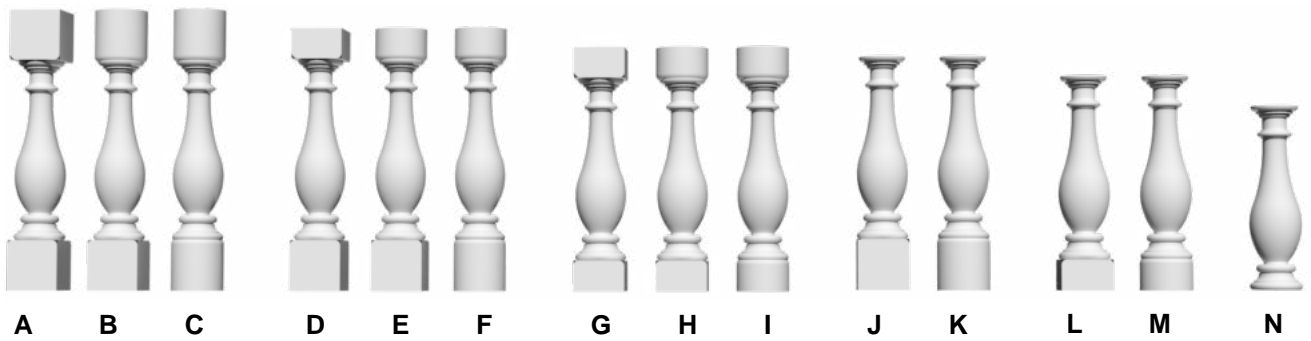

LEGACY BALUSTRADE SYSTEM

	Part Number	Spindle Width	Top Block Height	Bottom Block Height	Spindle Height	On Center Spacing	Spindles per Foot	*Overall System Height
A	BAL05X28LG-A	5"	5" Sq	5" Sq	28"	6-1/8"	1.96	42-1/2"
B	BAL05X28LG-B	5"	5" Rd	5" Sq	28"	6-1/8"	1.96	42-1/2"
C	BAL05X28LG-C	5"	5" Rd	5" Rd	28"	6-1/8"	1.96	42-1/2"
D	BAL05X26LG-D	5"	3" Sq	5" Sq	26"	6-1/8"	1.96	40-1/2"
E	BAL05X26LG-E	5"	3" Rd	5" Sq	26"	6-1/8"	1.96	40-1/2"
F	BAL05X26LG-F	5"	3" Rd	5" Rd	26"	6-1/8"	1.96	40-1/2"
G	BAL05X24LG-G	5"	3" Sq	3" Sq	24"	6-1/8"	1.96	38-1/2"
H	BAL05X24LG-H	5"	3" Rd	3" Sq	24"	6-1/8"	1.96	38-1/2"
I	BAL05X24LG-I	5"	3" Rd	3" Rd	24"	6-1/8"	1.96	38-1/2"
J	BAL05X23LG-J	5"	None	5" Sq	23"	6-1/8"	1.96	37-1/2"
K	BAL05X23LG-K	5"	None	5" Rd	23"	6-1/8"	1.96	37-1/2"
L	BAL05X21LG-L	5"	None	3" Sq	21"	6-1/8"	1.96	35-1/2"
M	BAL05X21LG-M	5"	None	3" Rd	21"	6-1/8"	1.96	35-1/2"
N	BAL05X18LG-N	5"	None	None	18"	6-1/8"	1.96	32-1/2"

Overall System Height includes 3 7/8" space below rail, bottom rail, top rail, and baluster height
 Estimated Price Per Foot includes top and bottom rails and balusters space to pass 4" sphere code

SPINDLE OPTIONS

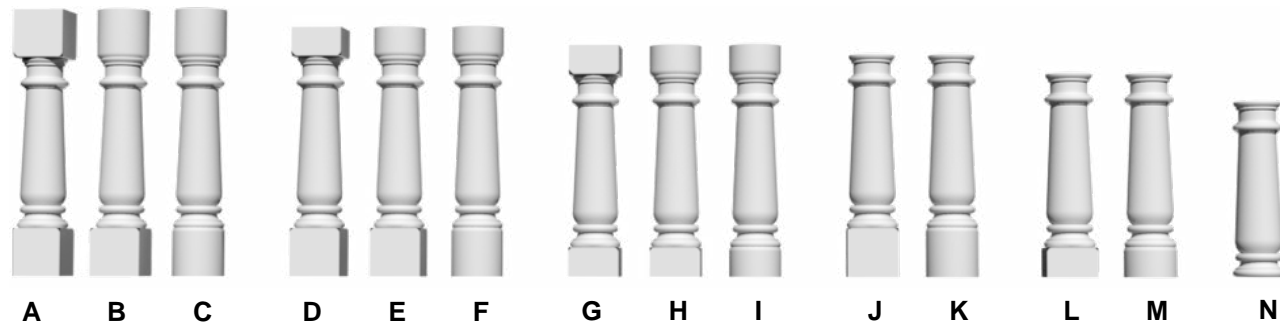

TOP BLOCK

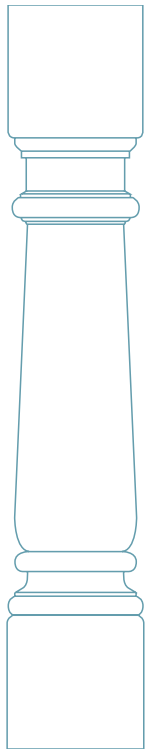

BOTTOM BLOCK



WELLINGTON BALUSTRADE SYSTEM

Part Number	Spindle Width	Top Block Height	Bottom Block Height	Spindle Height	On Center Spacing	Spindles per Foot	*Overall System Height
A	BAL05X28WE-A	5" Sq	5" Sq	28"	7-5/8"	1.57	42-1/2"
B	BAL05X28WE-B	5" Rd	5" Sq	28"	7-5/8"	1.57	42-1/2"
C	BAL05X28WE-C	5" Rd	5" Rd	28"	7-5/8"	1.57	42-1/2"
D	BAL05X26WE-D	3" Sq	5" Sq	26"	7-5/8"	1.57	40-1/2"
E	BAL05X26WE-E	3" Rd	5" Sq	26"	7-5/8"	1.57	40-1/2"
F	BAL05X26WE-F	3" Rd	5" Rd	26"	7-5/8"	1.57	40-1/2"
G	BAL05X24WE-G	3" Sq	3" Sq	24"	7-5/8"	1.57	38-1/2"
H	BAL05X24WE-H	3" Rd	3" Sq	24"	7-5/8"	1.57	38-1/2"
I	BAL05X24WE-I	3" Rd	3" Rd	24"	7-5/8"	1.57	38-1/2"
J	BAL05X23WE-J	None	5" Sq	23"	7-5/8"	1.57	37-1/2"
K	BAL05X23WE-K	None	5" Rd	23"	7-5/8"	1.57	37-1/2"
L	BAL05X21WE-L	None	3" Sq	21"	7-5/8"	1.57	35-1/2"
M	BAL05X21WE-M	None	3" Rd	21"	7-5/8"	1.57	35-1/2"
N	BAL05X18WE-N	None	None	18"	7-5/8"	1.57	32-1/2"

*Overall System Height includes 3 7/8" space below rail, bottom rail, top rail, and baluster height

**Estimated Price Per Foot includes top and bottom rails and balusters space to pass 4" sphere code

SPINDLE OPTIONS

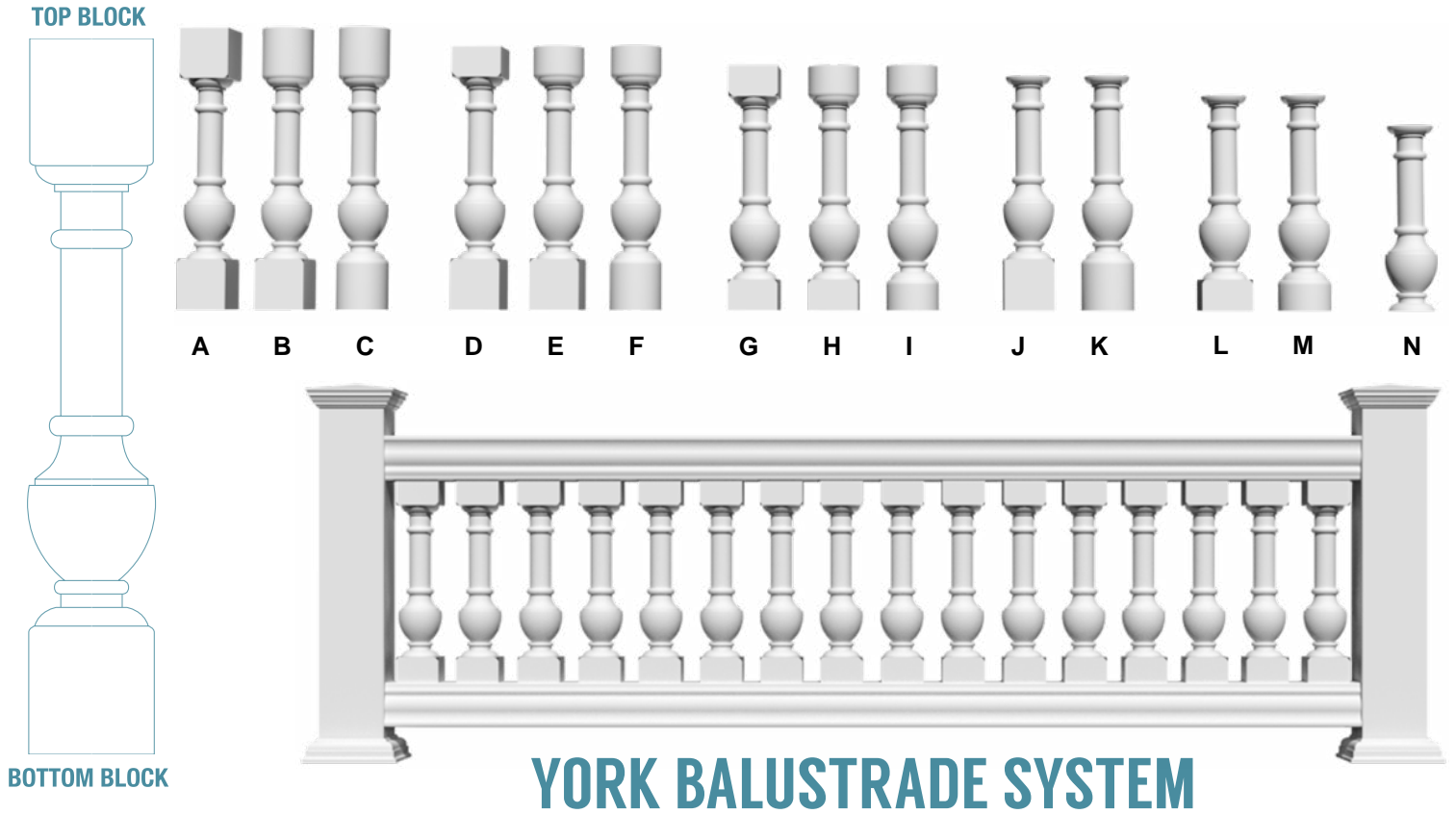

YORK BALUSTRADE SYSTEM

	Part Number	Spindle Width	Top Block Height	Bottom Block Height	Spindle Height	On Center Spacing	Spindles per Foot	*Overall System Height
A	BAL05X28YO-A	5"	5" Sq	5" Sq	28"	6-3/8"	1.88	42-1/2"
B	BAL05X28YO-B	5"	5" Rd	5" Sq	28"	6-3/8"	1.88	42-1/2"
C	BAL05X28YO-C	5"	5" Rd	5" Rd	28"	6-3/8"	1.88	42-1/2"
D	BAL05X26YO-D	5"	3" Sq	5" Sq	26"	6-3/8"	1.88	40-1/2"
E	BAL05X26YO-E	5"	3" Rd	5" Sq	26"	6-3/8"	1.88	40-1/2"
F	BAL05X26YO-F	5"	3" Rd	5" Rd	26"	6-3/8"	1.88	40-1/2"
G	BAL05X24YO-G	5"	3" Sq	3" Sq	24"	6-3/8"	1.88	38-1/2"
H	BAL05X24YO-H	5"	3" Rd	3" Sq	24"	6-3/8"	1.88	38-1/2"
I	BAL05X24YO-I	5"	3" Rd	3" Rd	24"	6-3/8"	1.88	38-1/2"
J	BAL05X23YO-J	5"	None	5" Sq	23"	6-3/8"	1.88	37-1/2"
K	BAL05X23YO-K	5"	None	5" Rd	23"	6-3/8"	1.88	37-1/2"
L	BAL05X21YO-L	5"	None	3" Sq	21"	6-3/8"	1.88	35-1/2"
M	BAL05X21YO-M	5"	None	3" Rd	21"	6-3/8"	1.88	35-1/2"
N	BAL05X18YO-N	5"	None	None	18"	6-3/8"	1.88	32-1/2"

*Overall System Height includes 3 7/8" space below rail, bottom rail, top rail, and baluster height
 **Estimated Price Per Foot includes top and bottom rails and balusters space to pass 4" sphere code

SPINDLE OPTIONS

The industry's only
full line of square
spindles -
The Arcadian Line

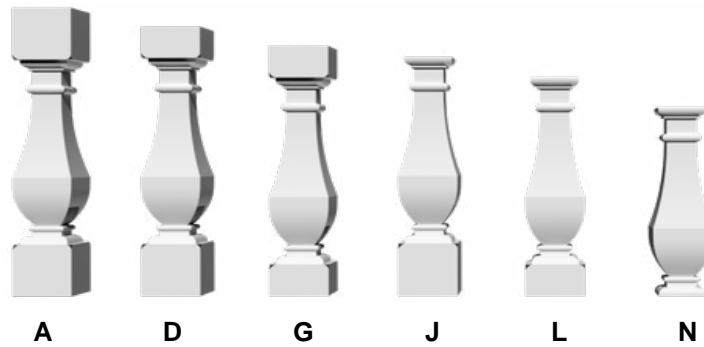

TOP BLOCK

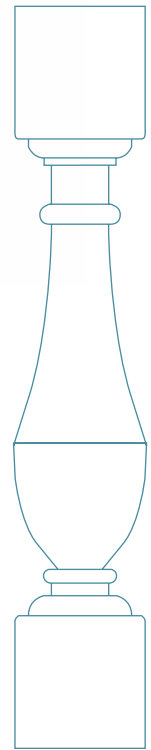

BOTTOM BLOCK



ARCADIAN BALUSTRADE SYSTEM

Part Number	Spindle Width	Top Block Height	Bottom Block Height	Spindle Height	On Center Spacing	Spindles per Foot	*Overall System Height	
A	BAL05X28AC-A	5"	5" Sq	5" Sq	28"	7-3/8"	1.63	42-1/2"
D	BAL05X26AC-D	5"	3" Sq	5" Sq	26"	7-3/8"	1.63	40-1/2"
G	BAL05X24AC-G	5"	3" Sq	3" Sq	24"	7-3/8"	1.63	38-1/2"
J	BAL05X23AC-J	5"	None	5" Sq	23"	7-3/8"	1.63	37-1/2"
L	BAL05X21AC-L	5"	None	3" Sq	21"	7-3/8"	1.63	35-1/2"
N	BAL05X18AC-N	5"	None	None	18"	7-3/8"	1.63	32-1/2"

all of our balustrades are
Available to Ship
 within
72 hours

*Overall System Height includes 3 7/8" space below rail, bottom rail, top rail, and baluster height
 **Estimated Price Per Foot includes top and bottom rails and balusters space to pass 4" sphere code

ECONOMY SPINDLE OPTIONS

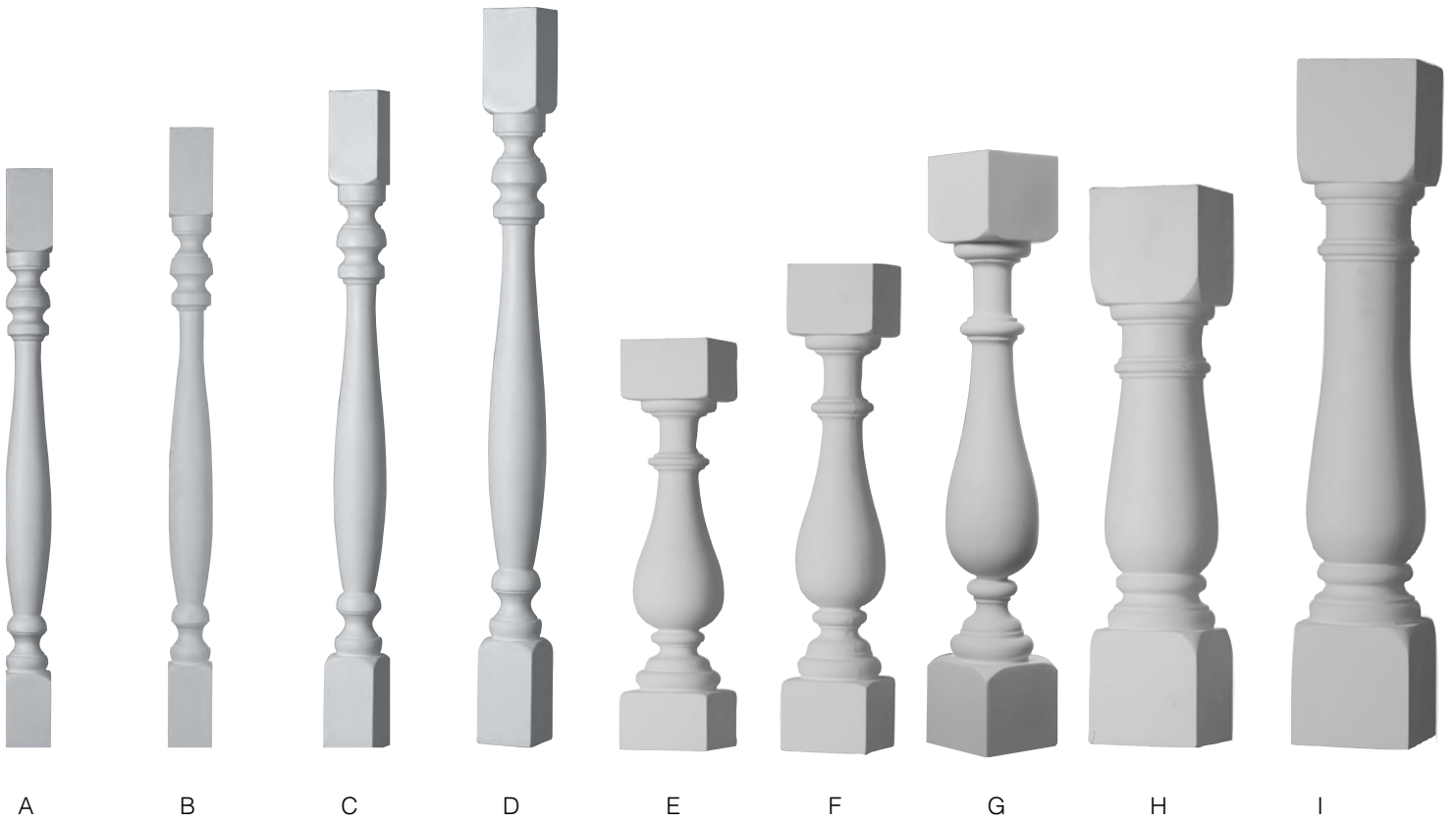

Key	Name	Width	Height	On Center Spacing
-----	------	-------	--------	-------------------

A	BAL02X24ST	2 1/2"	24"	5 1/4"
B	BAL02X28ST	2 1/2"	28"	5 1/4"
C	BAL02X32ST	2 1/2"	32"	5 1/4"
D	BAL02X36ST	2 1/2"	36"	5 1/4"
E	BAL04X19TR	4 1/4"	19"	5 11/16"
F	BAL04X23TR	4 1/4"	23"	5 11/16"
G	BAL04X27TR	4 1/4"	27"	5 11/16"
H	BAL05X24OX	5"	24"	7 1/2"
I	BAL05X28OX	5"	28"	7 1/2"



NEWEL POST

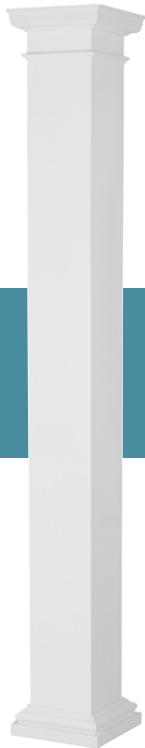

**Columns already come with a cap and base*



Choose between the smooth or paneled newel post options. If you choose paneled, don't forget to specify which type.

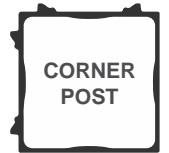

COLUMNS

Part Number	Description	Width	Height
EL0806ENPTUTU	Square Column	8"	72"
EL0808ENPTUTU	Square Column	8"	96"
EL0809ENPTUTU	Square Column	8"	108"
EL0810ENPTUTU	Square Column	8"	120"
EL1006ENPTUTU	Square Column	10"	72"
EL1008ENPTUTU	Square Column	10"	96"
EL1009ENPTUTU	Square Column	10"	108"
EL1010ENPTUTU	Square Column	10"	120"
EL1206ENPTUTU	Square Column	12"	72"
EL1208ENPTUTU	Square Column	12"	96"
EL1209ENPTUTU	Square Column	12"	108"
EL1210ENPTUTU	Square Column	12"	120"

NEWEL INSTALL KIT

Part Number	Description	Contents
FTNEWKIT	Newel Post Instalation Kit	4 Brackets, Back Plates, Washers, & Nuts

NEWEL POSTS

Part Number	Description	Width	Height
NWL08X40PL	Plain	8"	40"
NWL08X40CP	Corner w/Panel	8"	40"
NWL08X40SP	Straight Post w/Panel	8"	40"
NWL08X40EP	End Post w/Panel	8"	40"
NWL08X48PL	Plain	8"	48"
NWL08X48CP	Corner w/Panel	8"	48"
NWL08X48SP	Straight Post w/Panel	8"	48"
NWL08X48EP	End Post w/Panel	8"	48"
NWL10X40PL	Plain	10"	40"
NWL10X40CP	Corner w/Panel	10"	40"
NWL10X40SP	Straight Post w/Panel	10"	40"
NWL10X40EP	End Post w/Panel	10"	40"
NWL10X48PL	Plain	10"	48"
NWL10X48CP	Corner w/Panel	10"	48"
NWL10X48SP	Straight Post w/Panel	10"	48"
NWL10X48EP	End Post w/Panel	10"	48"
NWL12X40PL	Plain	12"	40"
NWL12X40CP	Corner w/Panel	12"	40"
NWL12X40SP	Straight Post w/Panel	12"	40"
NWL12X40EP	End Post w/Panel	12"	40"
NWL12X48PL	Plain	12"	48"
NWL12X48CP	Corner w/Panel	12"	48"
NWL12X48SP	Straight Post w/Panel	12"	48"
NWL12X48EP	End Post w/Panel	12"	48"

RAIL & COMPONENTS



FIN04X07BL



FIN03X04TR



FIN04X11UR



FIN04X08AB



FIN04X09SO



FIN06X13UR

If you want to use finials, here are six different options to choose from

**If you are ordering finials, make sure to order a FLAT top cap*

FLAT CAP



PEAKED CAP



BASE

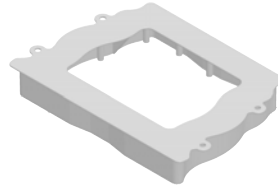

FTBRACKETS

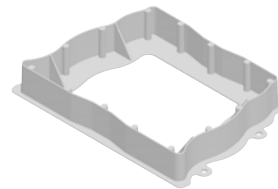

TR07X

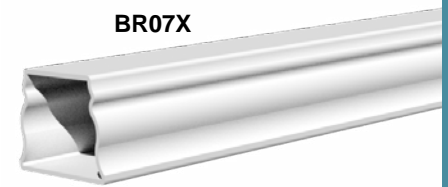

BR07X

FINIALS

Part Number	Description
FIN06X13UR	6 3/4"OD x 13"H x 6 15/16"BD Urn
FIN04X07BL	4 1/8"OD x 7"H Blackthorne
FIN03X04TR	3 3/8"OD x 4 3/4"H Traditional
FIN04X11UR	4 7/8"OD x 11 1/2"H Urn Finial
FIN04X08AB	4 7/8"OD x 8 1/4"H Aberdeen
FIN04X09SO	4 1/4"OD x 9 3/8"H Southampton

RAILING

Component	Part Number
Brackets	FTBRACKETS Rail Installation Kit (2 Quick-Install brackets)
Top Rail	TR07X - 7"W - Price per Foot
Bottom Rail	BR07X - 7"W - Price per Foot

CAPS AND BASE

Part Number	Description
NPC08X08F	Flat Newel Post Cap for 8" Newel Post
NPC10X10F	Flat Newel Post Cap for 10" Newel Post
NPC12X12F	Flat Newel Post Cap for 12" Newel Post
NPC08X08P	Peaked Newel Post Cap for 8" Newel Post
NPC10X10P	Peaked Newel Post Cap for 10" Newel Post
NPC12X12P	Peaked Newel Post Cap for 12" Newel Post
NPB08X08	Trim Base for 8" Newel Post
NPB10X10	Trim Base for 10" Newel Post
NPB12X12	Trim Base for 12" Newel Post

EVERYTHING ABOUT RAILING



VINYL



- *Packaged in 6' and 8' kits*
- *Pre-Finished white or tan*
- *Simple installation*
- *Lifetime warranty*
- *Available with turned or square spindles*
- *Ships within 5 days*
- *Stair and gate kits available*

CELLULAR PVC



- *Feel and look of real wood*
- *Sold in pre-built sections to your specs*
- *Sold in 6" increments ensuring perfect fit*
- *Virtually unlimited designs available*
- *Available in square or round spindles*
- *Pre-finished white, but can be painted*
- *Radius rails available*

ALUMINUM



- *Durably manufactured*
- *Packaged in kits*
- *No cracking or warping*
- *15 year material warranty*
- *7 finishes available*
- *Available with round or square spindles*
- *One of the strongest systems in the country*



HEIGHT 36" & 42" **LENGTH** 8', 10', & 12'

LIMITED LIFETIME WARRANTY



QUICK INSTALLATION



UV PROTECTED



IMPACT RESISTANT



VIRTUALLY MAINTENANCE FREE



VIBRANT WHITE OR DESERT TAN COLOR



NEVER NEEDS PAINTING



TRI-LAYERED COMPOSITE TECHNOLOGY

SQUARE SPINDLE



WHITE



TAN



TURNED COLONIAL SPINDLE



WHITE



TAN



PVC RAILING SYSTEMS



SPIDERWEB

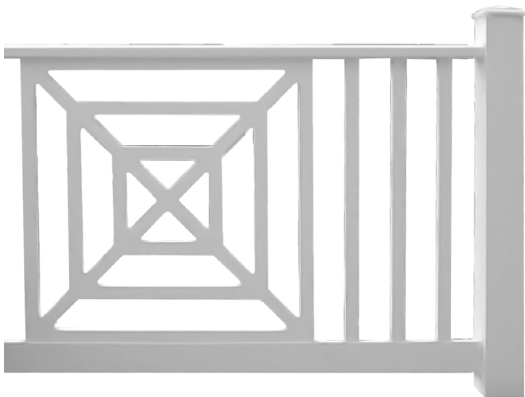

BULLSEYE

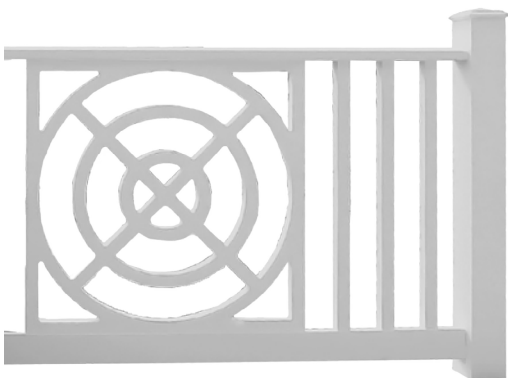

**PREBUILT AND
READY TO INSTALL**

**UNLIMITED DESIGN
POSSIBILITIES**

**SHIPS IN 3
BUSINESS DAYS**

PVC RAILING SYSTEMS

EASY TO INSTALL



LOW MAINTENANCE



PRE-FINISHED



WEATHER RESISTANT CELLULAR PVC



25 YEAR WARRANTY



10 YEAR TOP COAT WARRANTY



RADIUS RAIL AVAILABLE



LOOKS AND FEELS LIKE WOOD



UP TO 10' IN LENGTH



PAINTABLE

ALUMINUM STRUCTURED IN RAILS

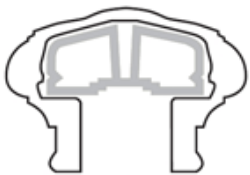

SAVANNAH TOP



STANDARD TOP



BOTTOM RAIL

TURNED SPINDLE

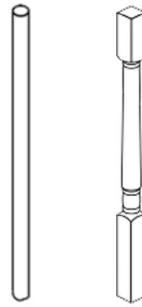

SQUARE SPINDLE

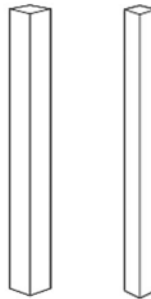

DOUBLE SQUARE SPINDLE

the double square spindle is one of the hundreds of designs possible with the PVC railing system



ALUMINUM RAILING



FAST ASSEMBLY • EASY INSTALLATION • FIXED & ADJUSTABLE STAIR RAIL

SERIES 100

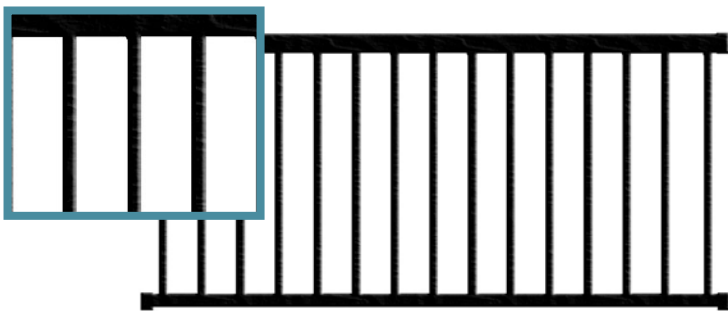

ALL SERIES AVAILABLE IN

36" x 48"
36" x 72"
36" x 96"
36" x 120"

SERIES 125A

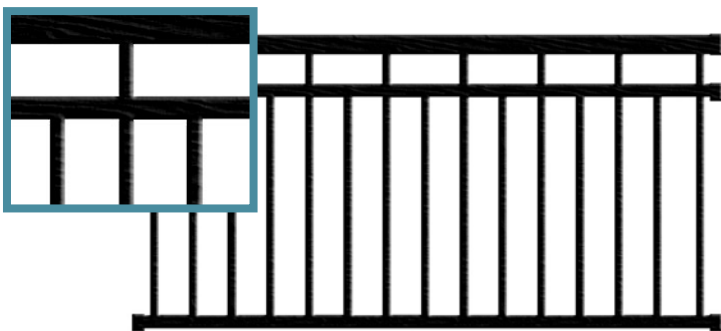

42" x 48"
42" x 72"
42" x 96"
42" x 120"

ALUMINUM RAILING

EXTRUDED FROM 6063 ALUMINUM ALLOY



POWDER COAT PAINT



WILL NOT RUST



THREE HIGH GLOSS COLORS AND THREE TEXTURED, LOW GLOSS FINISHES



22.5 & 45 DEGREE ANGLE RACKETS



ROUND BALUSTERS OPTIONAL



ROUND OR SQUARE SPINDLES



15 YEAR MATERIAL WARRANTY & 5 YEAR FINISH WARRANTY



FIXED AND ADJUSTABLE STAIR BRACKET

SERIES 125B



SERIES 125C

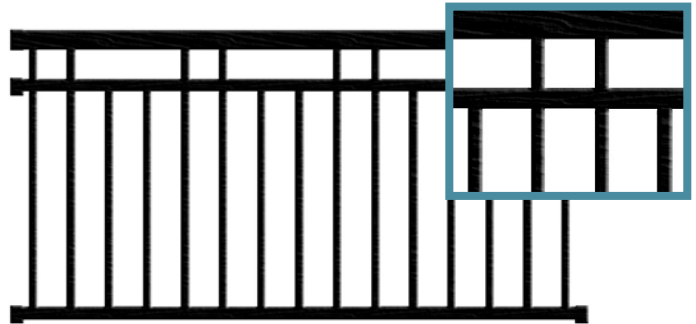

SERIES 125D

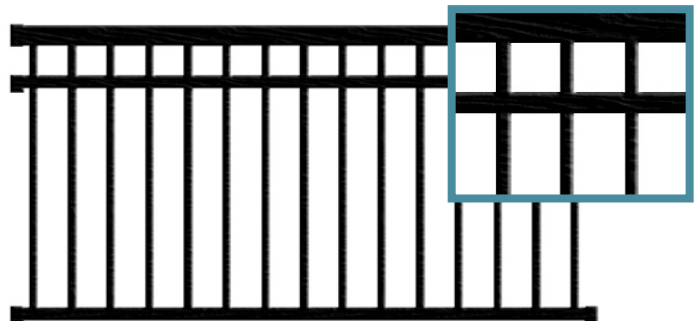

OVER THE POST SERIES AVAILABLE

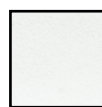

TEXTURED WHITE

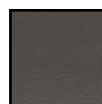

TEXTURED BRONZE

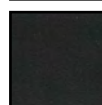

TEXTURED BLACK



GLOSSY WHITE



GLOSSY WICKER



GLOSSY CLAY

SHUTTERS





ATLANTIC



VINYL



Shutters qualify for the
Local Pro Program!

WOOD



PREMIUM



COMPOSITE



COMPARING MATERIALS

	Vinyl	Wood	Composite	Premium	Atlantic
AVAILABLE SIZES AND STYLES					
stock sizes	●	—	—	—	—
custom sizes	●	●	●	●	●
INSTALLATION OPTIONS					
non-operable installation	●	●	●	●	●
operable installation available	—	●	●	●	●
HARDWARE INCLUDED					
non-operable hardware included	●	—	●	—	—
FINISH OPTIONS					
pre-finished in a variety of colors	●	●	●	●	●
can be painted	●	●	●	●	●
can be stained	—	●	—	—	—
WARRANTY					
1 yr. material & construction warranty	●	●	●	●	●
10 yr. material & construction warranty	●	—	●	●	●
15 yr. material, construction, & finish warranty	●	—	—	●	●
40 yr. material, construction, & finish warranty	●	—	—	●	—
limited lifetime warranty	—	—	—	●	—
price point	\$	\$\$	\$\$\$	\$\$\$\$	\$\$\$\$\$\$

STANDARD SIZE VINYL SHUTTERS



PRE-COLORED OR PRIMED



40 YEAR WARRANTY



EASY INSTALLATION



INSTALLATION HARDWARE INCLUDED



SHIPS WITHIN 48 HOURS



DECORATIVE HARDWARE AVAILABLE



MOST COST-EFFECTIVE SHUTTERS



- 1. White
- 2. Black
- 3. Blue
- 4. Brown
- 5. Cranberry/Bordeaux
- 6. Gray/Tuxedo Gray
- 7. Forest Green
- 8. Indigo Blue/Classic Blue
- 9. Red/Burgundy Red
- 10. Sandstone/Clay
- 11. Berry Red/Wineberry
- 12. Chocolate Brown/Musket Brown
- 13. Pine Green/ Midnight Green
- 14. Royal Blue/Midnight Blue

STANDARD SIZE VINYL SHUTTERS

LOUVERED

12" Wide Height Options

28" 51"
31" 55"
35" 59"
39" 64"
43" 67"
47" 71"

14" Wide Height Options

31" 59"
35" 62"
39" 66"
43" 70"
47" 74"
51" 80"
54"



RAISED PANEL

12" Wide Height Options

28" 51"
31" 55"
35" 59"
39" 64"
43" 67"
47" 71"

14.5" Wide Height Options

25" 55"
31" 59"
35" 62"
39" 66"
43" 71"
47" 75"
51" 80"



BOARD-N-BATTEN

12" Wide Height Options

31" 59"
35" 63"
39" 67"
43" 71"
47" 75"
51" 80"
55"

14" Wide Height Options

31" 59"
35" 63"
39" 67"
43" 71"
47" 75"
51" 80"
55"



CUSTOM VINYL SHUTTERS



PRE-COLORED OR PRIMED



40 YEAR WARRANTY



EASY INSTALLATION



THOUSANDS OF SIZE & COLOR COMBINATIONS



SHIPS WITHIN 24 HOURS



DECORATIVE HARDWARE AVAILABLE



INSTALLATION HARDWARE INCLUDED



- 1. White
- 2. Black
- 3. Wedgewood Blue
- 4. Clay
- 5. Federal Brown
- 6. Musket Brown
- 7. Light Gray
- 8. Tuxedo Gray
- 9. Cream
- 10. Wicker
- 11. Burgundy Red
- 12. Forest Green
- 13. Classic Blue
- 14. Wineberry
- 15. Bright White
- 16. Midnight Green
- 17. Midnight Blue
- 18. Bordeaux

CUSTOM VINYL SHUTTERS

RAISED PANEL



BOARD-N-BATTEN JOINED

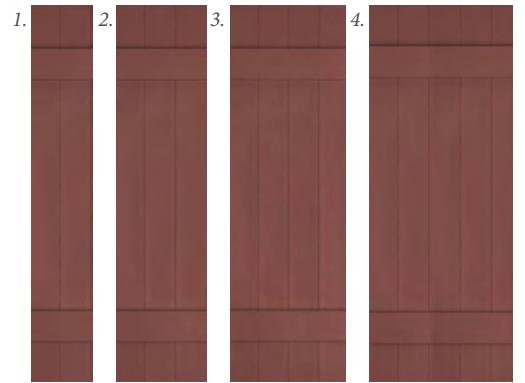

BOARD-N-BATTEN SPACED

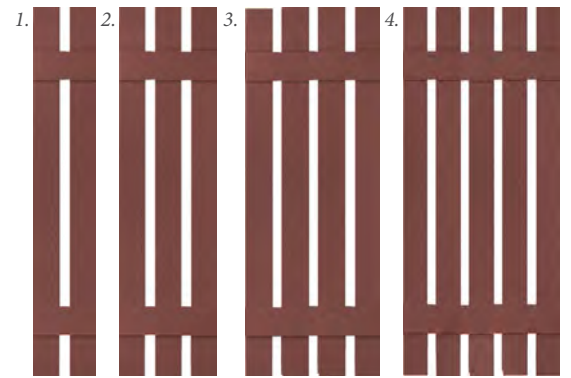

LOUVER



COMBINATION





WOOD SPECIES:

Pine, Western Red Cedar, Redwood, Cypress, Sapele Mahogany

1. Brilliant White
2. Country Red
3. Cottage Red
4. Tudor Brown
5. Chrome Green
6. Black Forest Green
7. Black

PRE-PAINTED, PRIMED OR UNFINISHED



MULTIPLE WOODS AVAILABLE



VIRTUALLY UNLIMITED SIZES



EASY INSTALLATION



FUNCTIONAL HARDWARE AVAILABLE



DECORATIVE HARDWARE AVAILABLE

WIDTHS

Range from 9"-36"

HEIGHTS

Range from 15"-150"

CUSTOM

Sizes and Designs

WOOD SHUTTERS

RAISED PANEL



COMBINATION

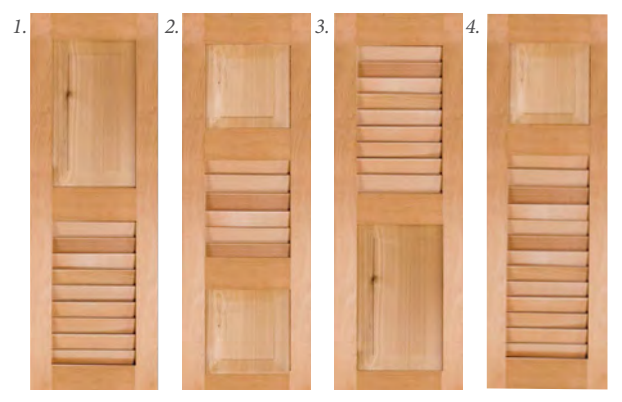

FLAT PANEL

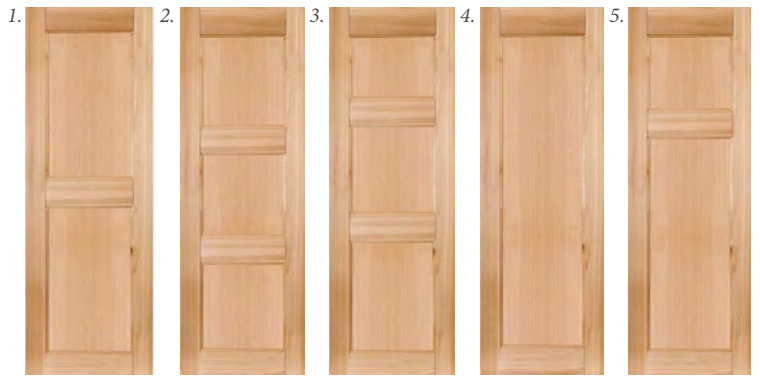

BAHAMA/BERMUDA



LOUVER

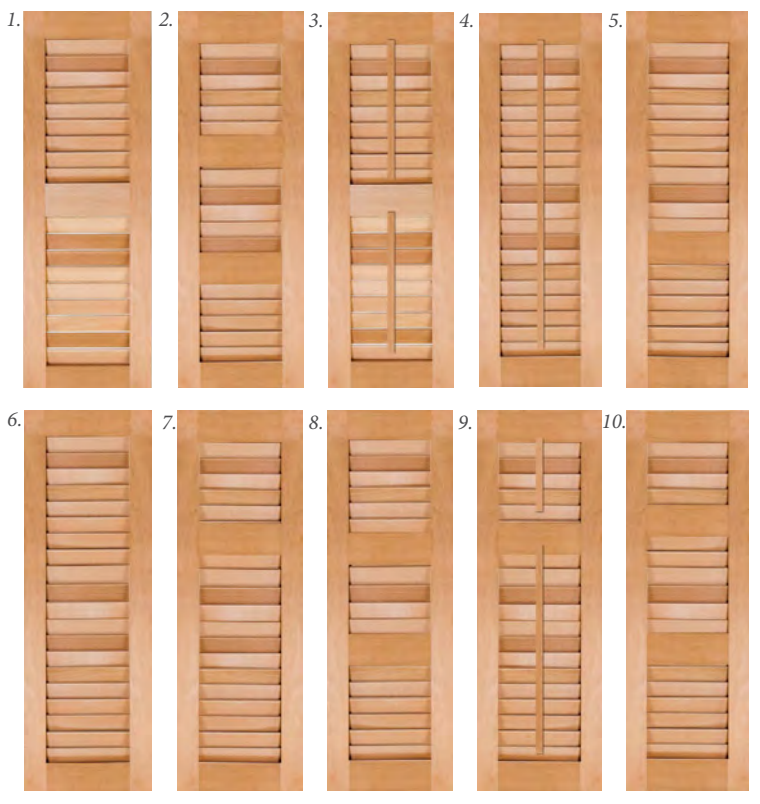

BOARD-N-BATTEN

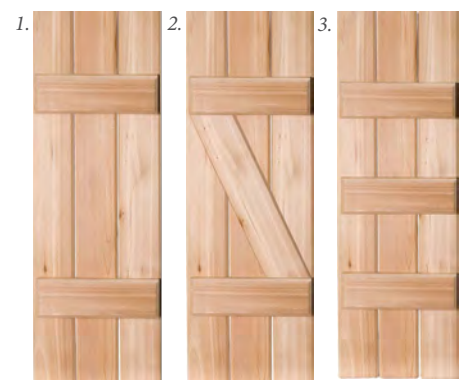



LOOK & FEEL OF REAL WOOD



- 1. Brilliant White
- 2. Country Red
- 3. Cottage Red
- 4. Tudor Brown
- 5. Chrome Green
- 6. Black Forest Green
- 7. Black

PRE-PAINTED OR PRIMED



10 YEAR WARRANTY



VIRTUALLY UNLIMITED SIZES



EASY INSTALLATION



FUNCTIONAL HARDWARE AVAILABLE



DECORATIVE HARDWARE AVAILABLE

WIDTHS
Range from 9"-36"

HEIGHTS
Range from 15"-150"

CUSTOM
Sizes and Designs

COMPOSITE SHUTTERS

RAISED PANEL

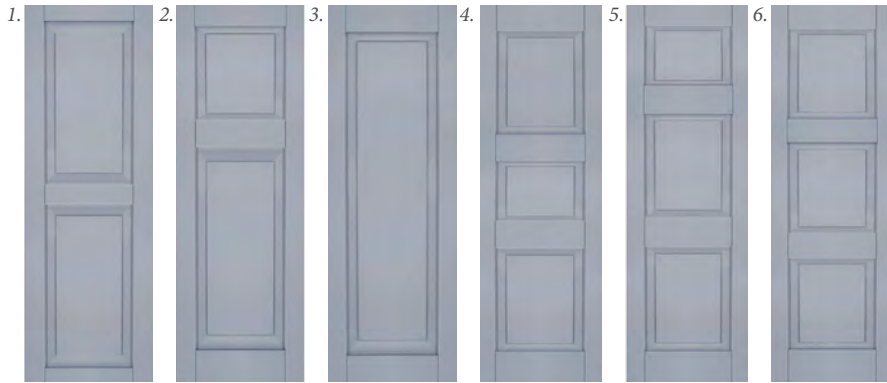

BOARD-N-BATTEN

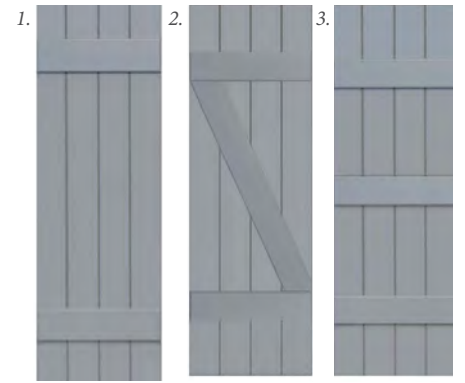

FLAT PANEL



COMBINATION

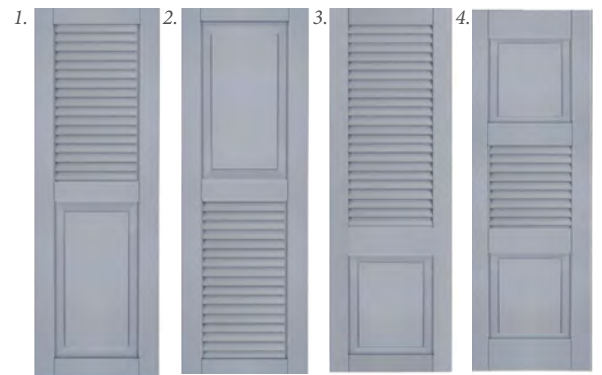

LOUVER

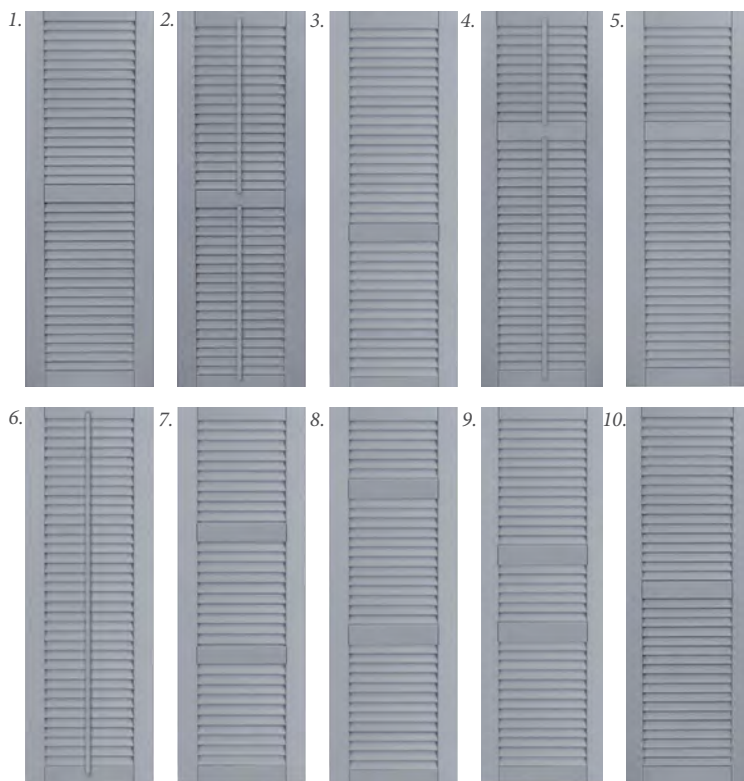

FRAMED BOARD-N-BATTEN

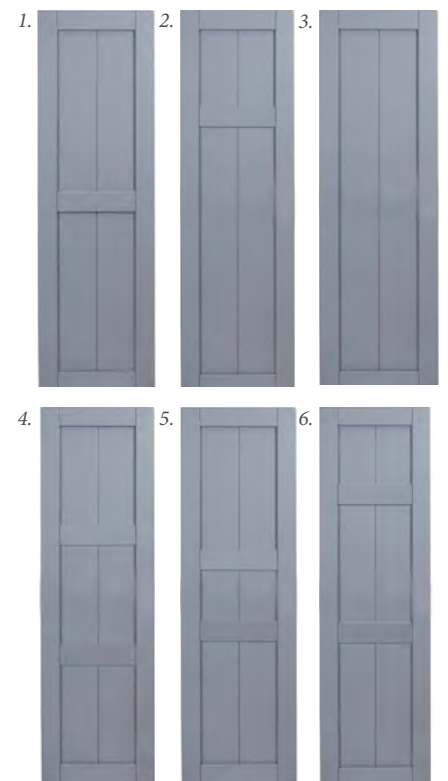

PREMIUM SHUTTERS



PRE-PAINTED OR PRIMED



LIFETIME WARRANTY



ARCHITECTURAL SOCIETY APPROVED



INSTALLATION HARDWARE AVAILABLE



INSTALLATION HARDWARE AVAILABLE

WIDTHS

Range from 9"-36"

HEIGHTS

Range from 15"-150"

CUSTOM

Sizes and Designs

ASK ABOUT CUSTOM COLORS



1. Classical White
2. White
3. Driftwood
4. Pewter
5. Chelsea Gray
6. Roycraft Pewter
7. Weathered Shingle
8. Quaker Bronze
9. Federal Brown
10. Board-n-Batten Red
11. Bordeaux
12. Polished Mahogany
13. Bahama Blue
14. Stratford Blue
15. Hamilton Blue
16. Deep Sea Blue
17. Hunter Green
18. Forest Green
19. Essex Green
20. Evergreen
21. Roycraft Forest Green
22. Black Forest Green
23. Charleston Green
24. Black
25. Tricorn Black

PREMIUM SHUTTERS

RAISED PANEL

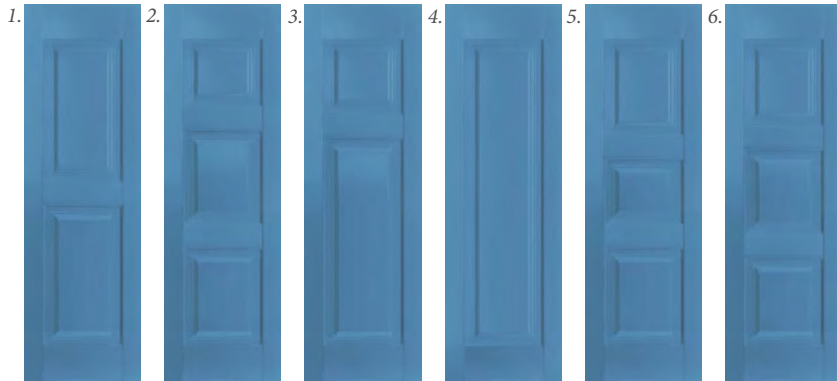

COMBINATION

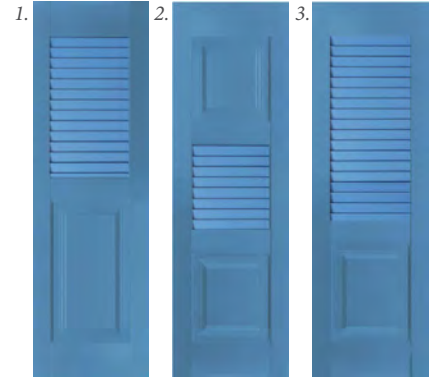

FLAT PANEL

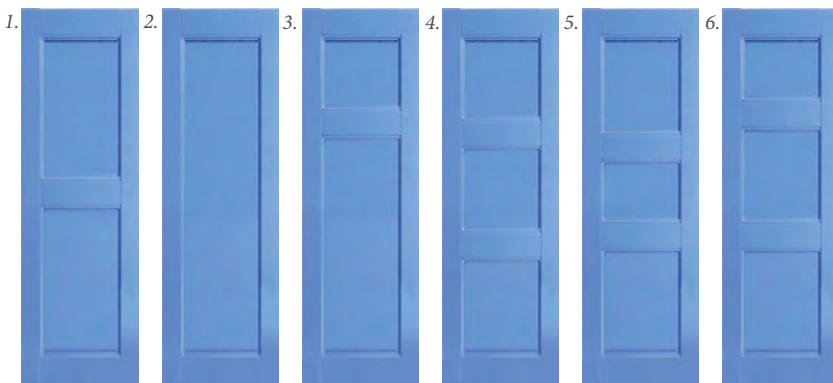

BAHAMA/BERMUDA

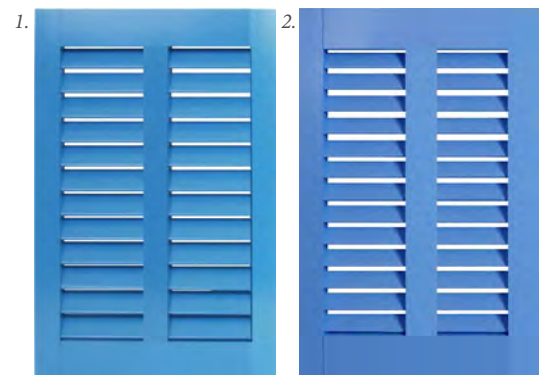

LOUVER

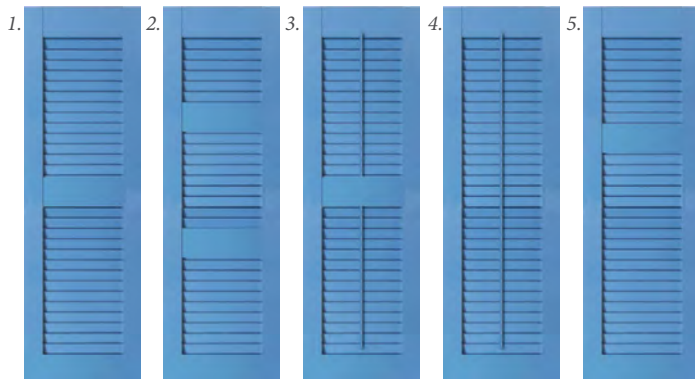

BOARD-N-BATTEN

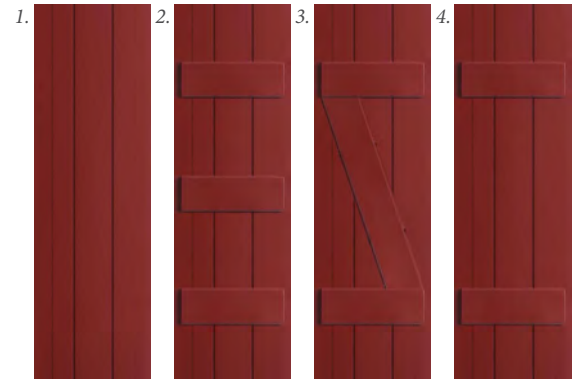

FRAMED BOARD-N-BATTEN

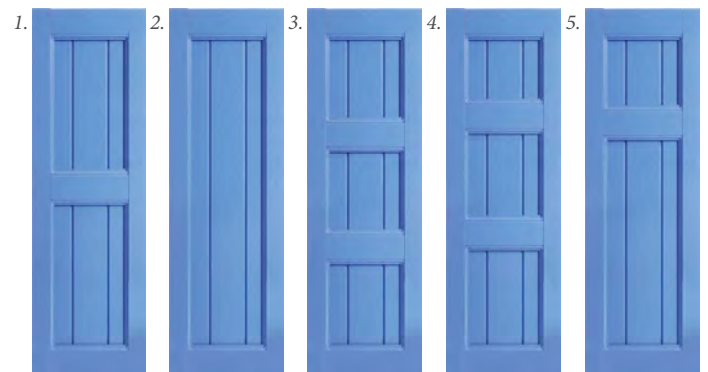
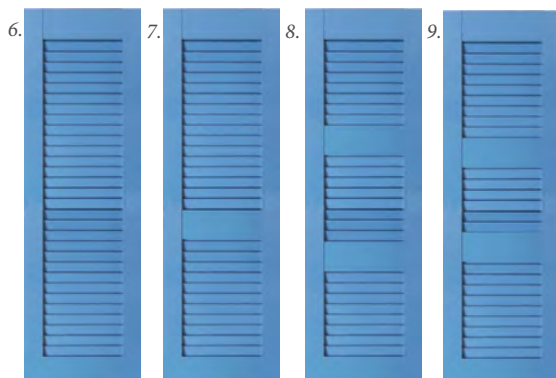

ARCHITECTURAL ATLANTIC SHUTTERS



PRE-PAINTED OR PRIMED



15 YEAR WARRANTY



ARCHITECTURAL SOCIETY APPROVED



INSTALLATION HARDWARE AVAILABLE



FUNCTIONAL HARDWARE AVAILABLE

WIDTHS

Range from 9"-36"

HEIGHTS

Range from 15"-150"

CUSTOM

Sizes and Designs



1. Black
2. Board and Batton Red
3. Bordeaux
4. Canyon
5. Cascade
6. Charleston Green
7. Chelsea Gray
8. Classical White
9. Craftsman Brown
10. Deep Sea Blue
11. Driftwood
12. Evergreen
13. Federal Brown
14. Forest Green
15. Garnet
16. Hamilton Blue
17. Hammered Silver
18. Harbor
19. Midnight Sky
20. Pewter
21. Pine
22. Plum Creek
23. Polished Mahogany
24. Redwood
25. Rookwood Dark Green
26. Rookwood Medium Brown
27. Rookwood Shutter Green
28. Roycraft Bottle Green
29. Roycraft Copper Red
30. Roycraft Mist Gray
31. Roycraft Pewter
32. Sand
33. Stratford Blue
34. Tempest Blue
35. Tricone Black
36. Walnut
37. Weathered Shingle
38. White
39. Wicker
40. Wineberry

ARCHITECTURAL ATLANTIC SHUTTERS

FLAT PANEL



BAHAMA

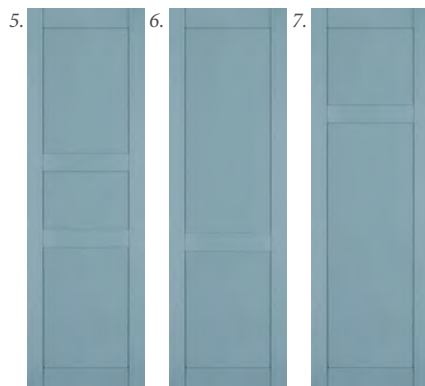
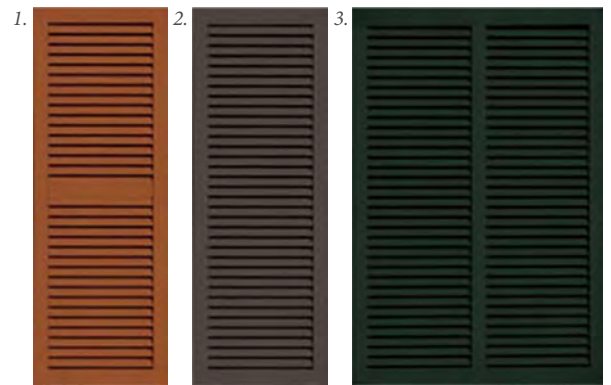

COMBINATION

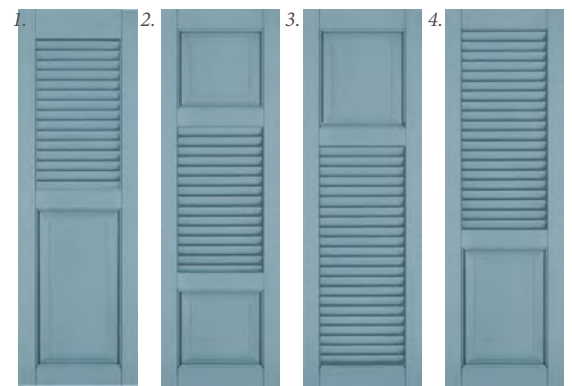

LOUVER

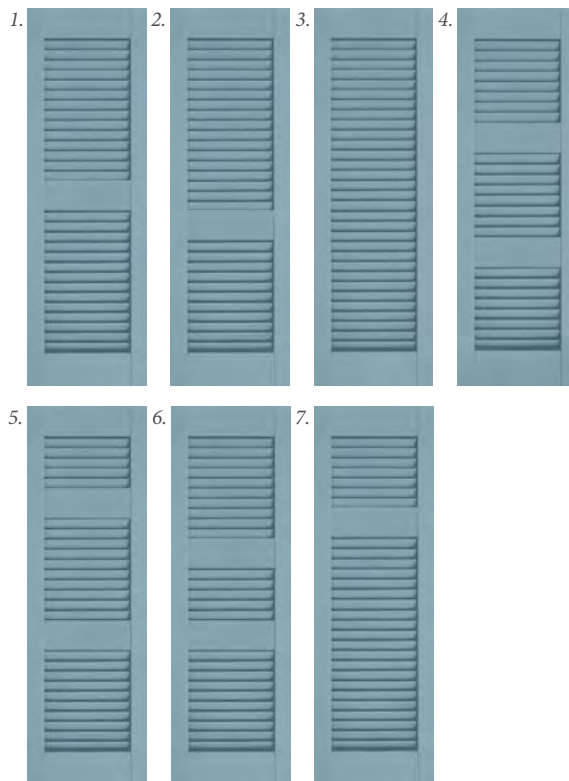

RAISED PANEL

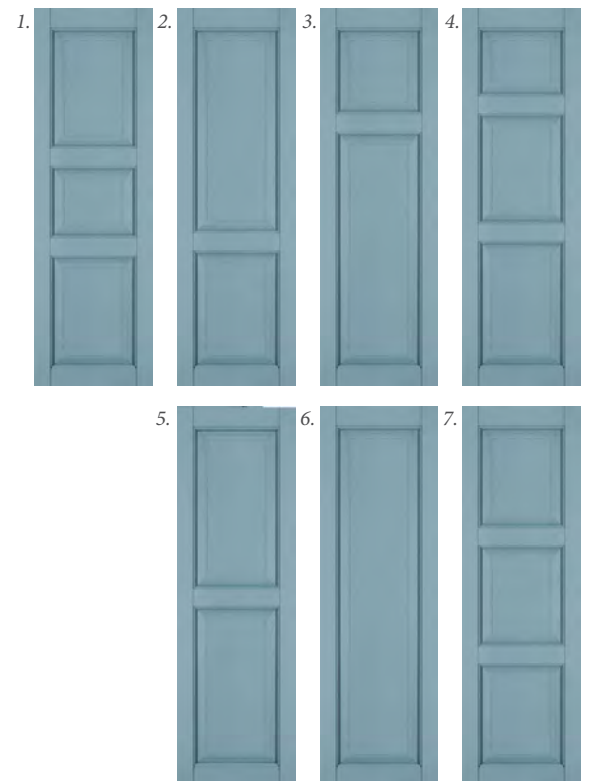

ATLANTIC CLASSIC SHUTTERS



PRE-PAINTED OR PRIMED



10 YEAR WARRANTY



VIRTUALLY UNLIMITED SIZES



LOOK AND FEEL OF WOOD



DECORATIVE HARDWARE AVAILABLE



INSTALLATION HARDWARE AVAILABLE



FUNCTIONAL HARDWARE AVAILABLE



1. Black
2. Board and Batton Red
3. Bordeaux
4. Canyon
5. Cascade
6. Charleston Green
7. Chelsea Gray
8. Classical White
9. Craftsman Brown
10. Deep Sea Blue
11. Driftwood
12. Evergreen
13. Federal Brown
14. Forest Green
15. Garnet
16. Hamilton Blue
17. Hammered Silver
18. Harbor
19. Midnight Sky
20. Pewter
21. Pine
22. Plum Creek
23. Polished Mahogany
24. Redwood
25. Rookwood Dark Green
26. Rookwood Medium Brown
27. Rookwood Shutter Green
28. Roycraft Bottle Green
29. Roycraft Copper Red
30. Roycraft Mist Gray
31. Roycraft Pewter
32. Sand
33. Stratford Blue
34. Tempest Blue
35. Tricone Black
36. Walnut
37. Weathered Shingle
38. White
39. Wicker
40. Wineberry

ATLANTIC CLASSIC SHUTTERS



RAISED PANEL

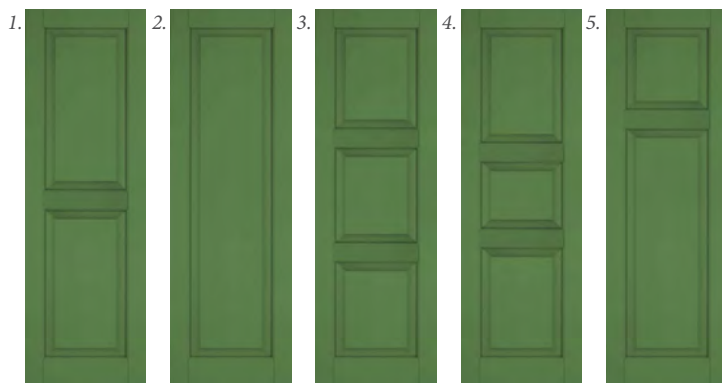

BOARD-N-BATTEN

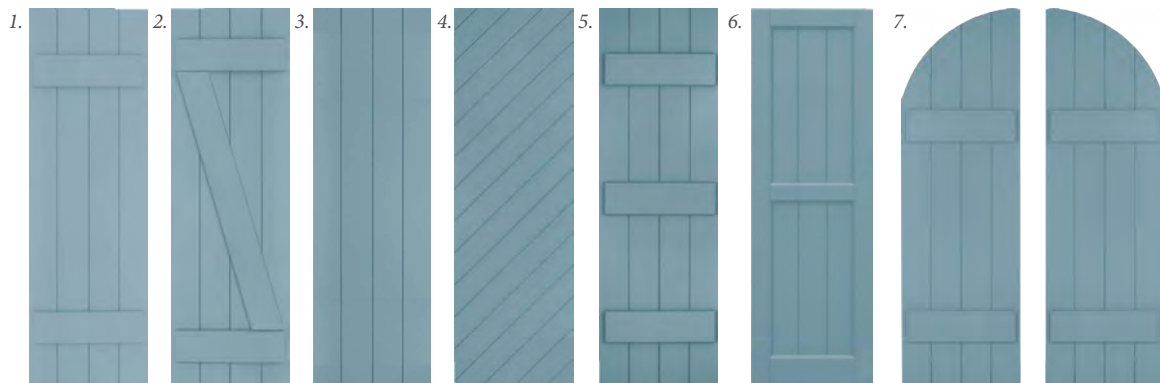

LOUVER



WIDTHS

Range from 9"-36"

HEIGHTS

Range from 15"-150"

CUSTOM

Sizes and Designs

SHUTTER HARDWARE

**WE HAVE AN ARRAY OF
HARDWARE FOR YOUR NEW SHUTTERS.**
CALL OR CHECK ONLINE FOR MORE OPTIONS & INFORMATION



rat tail
holdback



"S" holdback



acorn clip
holdback

decorative shutter installation screws



shutter-lock



shutter screw with
color match cap

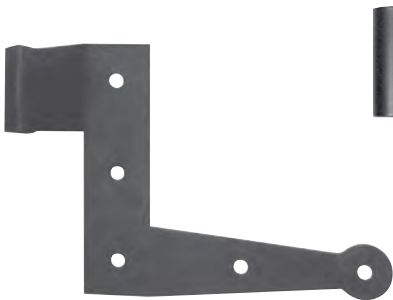

L-hinge



flat hinge



pintel on plate



lag pintel



strap hinge



shutter slide bolt

ASK ABOUT SHUTTER SAMPLES!



MILLWORK



There are various ways to enhance the look of your home. Our extensive collection of exterior products is sure to provide the look necessary to help your home stand out. Contact one of our product specialists and you will be on your way to a beautiful and unique home.

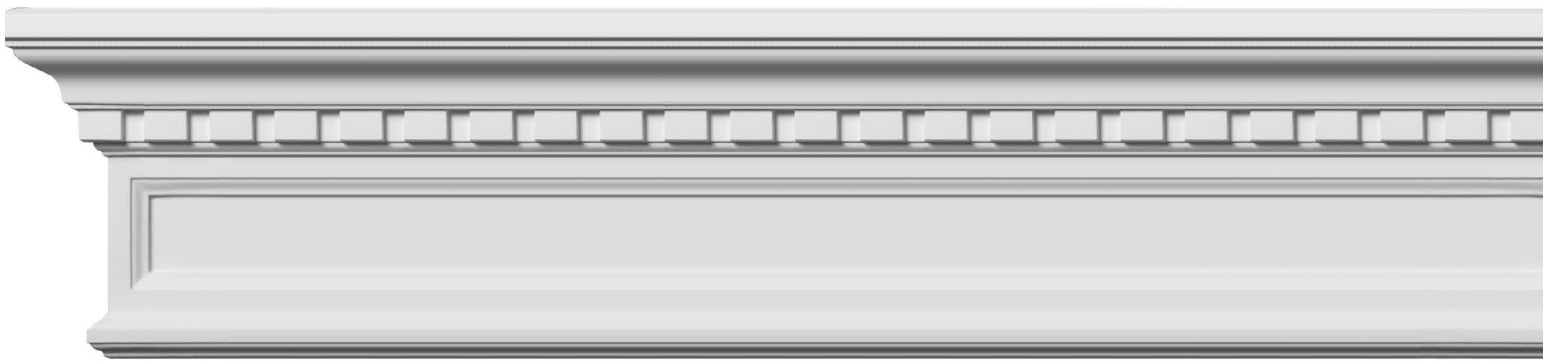
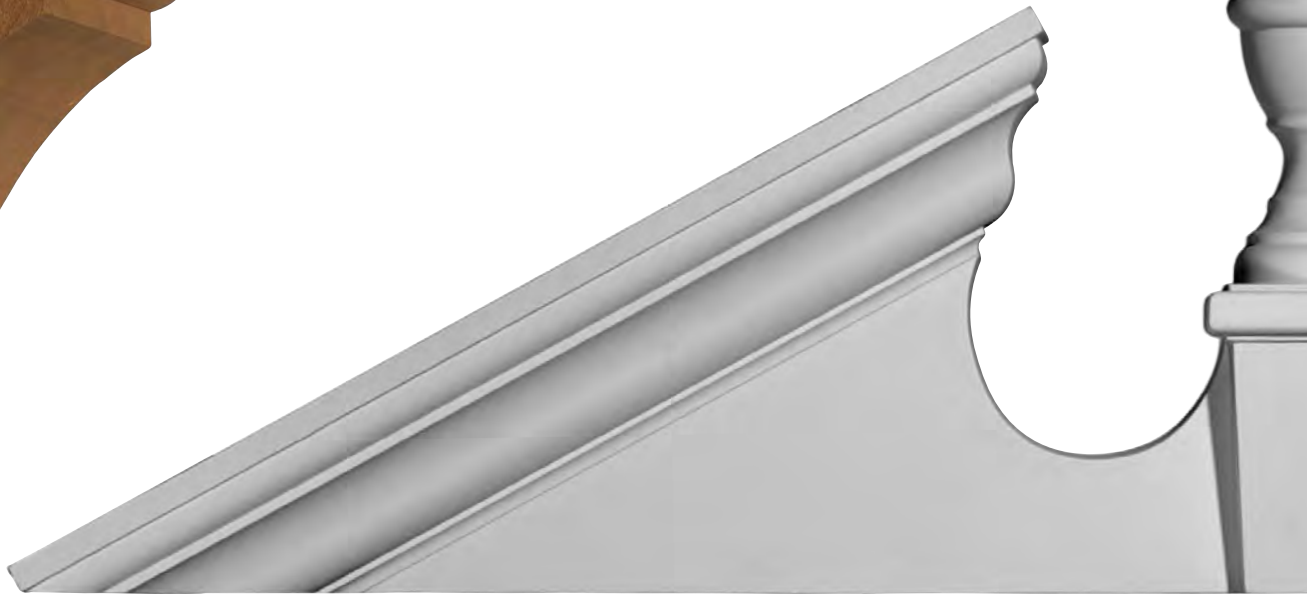

CROSSHEADS



6" TRADITIONAL WINDOW & DOOR CROSSHEAD

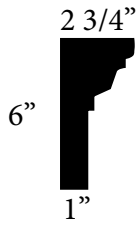

Want a keystone with your crosshead? Choose a style above and add either KA or KF to the end of the part number.

CRH06X34KA

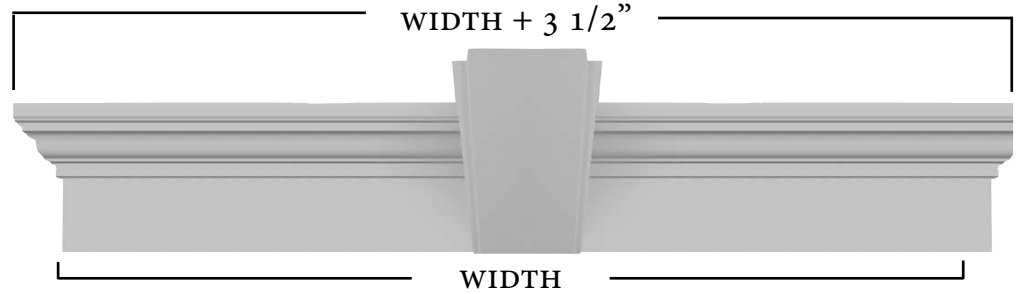
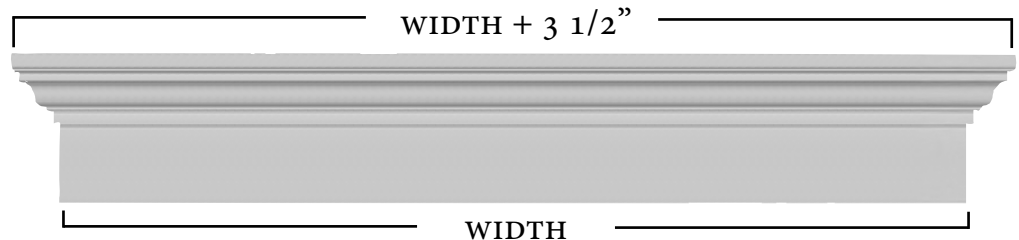

Part Number	Width
CRH06X24	24"
CRH06X25	25"
CRH06X26	26"
CRH06X27	27"
CRH06X28	28"
CRH06X29	29"
CRH06X30	30"
CRH06X31	31"
CRH06X32	32"
CRH06X33	33"
CRH06X34	34"
CRH06X35	35"
CRH06X36	36"
CRH06X37	37"
CRH06X38	38"
CRH06X39	39"
CRH06X40	40"
CRH06X41	41"
CRH06X42	42"
CRH06X43	43"
CRH06X44	44"
CRH06X45	45"
CRH06X46	46"
CRH06X47	47"
CRH06X48	48"
CRH06X49	49"
CRH06X50	50"
CRH06X51	51"
CRH06X52	52"

Part Number	Width
CRH06X53	53"
CRH06X54	54"
CRH06X55	55"
CRH06X56	56"
CRH06X57	57"
CRH06X58	58"
CRH06X59	59"
CRH06X60	60"
CRH06X61	61"
CRH06X62	62"
CRH06X63	63"
CRH06X64	64"
CRH06X65	65"
CRH06X66	66"
CRH06X67	67"
CRH06X68	68"
CRH06X69	69"
CRH06X70	70"
CRH06X71	71"
CRH06X72	72"
CRH06X73	73"
CRH06X74	74"
CRH06X75	75"
CRH06X76	76"
CRH06X77	77"
CRH06X78	78"
CRH06X79	79"
CRH06X80	80"
CRH06X81	81"

Part Number	Width
CRH06X82	82"
CRH06X83	83"
CRH06X84	84"
CRH06X85	85"
CRH06X86	86"
CRH06X87	87"
CRH06X88	88"
CRH06X89	89"
CRH06X90	90"
CRH06X91	91"
CRH06X92	92"
CRH06X93	93"
CRH06X94	94"
CRH06X95	95"
CRH06X96	96"
CRH06X97	97"
CRH06X98	98"
CRH06X99	99"
CRH06X100	100"
CRH06X101	101"
CRH06X102	102"
CRH06X103	103"
CRH06X104	104"
CRH06X105	105"
CRH06X106	106"
CRH06X107	107"
CRH06X108	108"

**we can do larger,
call for more information.**

7" TRADITIONAL WINDOW & DOOR CROSSHEAD

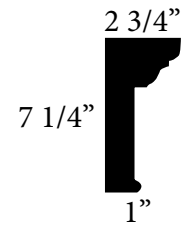
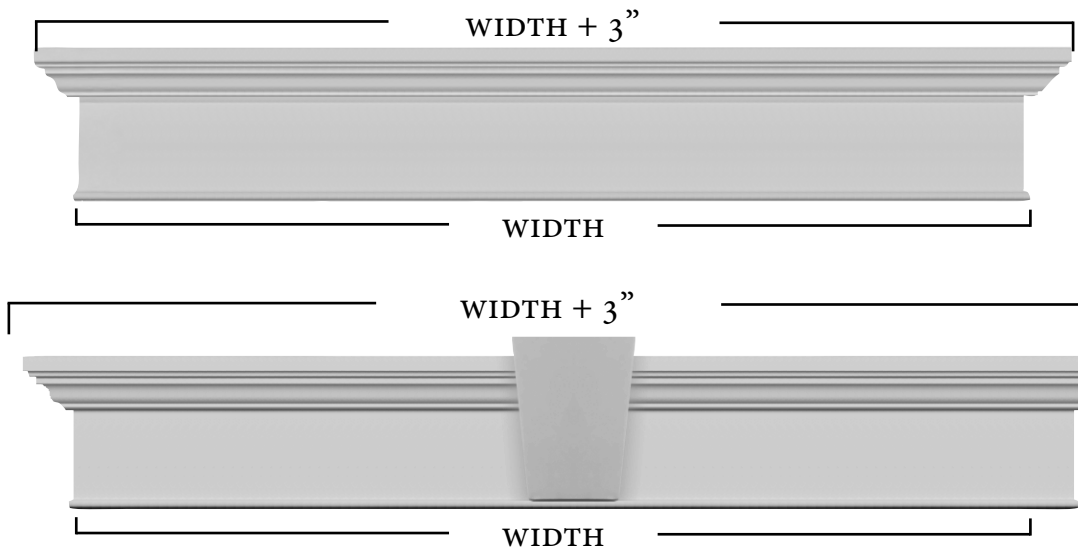

Want a keystone with your crosshead? Choose a style above and add either KA or KF to the end of the part number.

CRH06X34KA

Part Number	Width
CRH07X24BT	24"
CRH07X25BT	25"
CRH07X26BT	26"
CRH07X27BT	27"
CRH07X28BT	28"
CRH07X29BT	29"
CRH07X30BT	30"
CRH07X31BT	31"
CRH07X32BT	32"
CRH07X33BT	33"
CRH07X34BT	34"
CRH07X35BT	35"
CRH07X36BT	36"
CRH07X37BT	37"
CRH07X38BT	38"
CRH07X39BT	39"
CRH07X40BT	40"
CRH07X41BT	41"
CRH07X42BT	42"
CRH07X43BT	43"
CRH07X44BT	44"
CRH07X45BT	45"
CRH07X46BT	46"
CRH07X47BT	47"
CRH07X48BT	48"
CRH07X49BT	49"
CRH07X50BT	50"
CRH07X51BT	51"
CRH07X52BT	52"

Part Number	Width
CRH07X53BT	53"
CRH07X54BT	54"
CRH07X55BT	55"
CRH07X56BT	56"
CRH07X57BT	57"
CRH07X58BT	58"
CRH07X59BT	59"
CRH07X60BT	60"
CRH07X61BT	61"
CRH07X62BT	62"
CRH07X63BT	63"
CRH07X64BT	64"
CRH07X65BT	65"
CRH07X66BT	66"
CRH07X67BT	67"
CRH07X68BT	68"
CRH07X69BT	69"
CRH07X70BT	70"
CRH07X71BT	71"
CRH07X72BT	72"
CRH07X73BT	73"
CRH07X74BT	74"
CRH07X75BT	75"
CRH07X76BT	76"
CRH07X77BT	77"
CRH07X78BT	78"
CRH07X79BT	79"
CRH07X80BT	80"
CRH07X81BT	81"

Part Number	Width
CRH07X82BT	82"
CRH07X83BT	83"
CRH07X84BT	84"
CRH07X85BT	85"
CRH07X86BT	86"
CRH07X87BT	87"
CRH07X88BT	88"
CRH07X89BT	89"
CRH07X90BT	90"
CRH07X91BT	91"
CRH07X92BT	92"
CRH07X93BT	93"
CRH07X94BT	94"
CRH07X95BT	95"
CRH07X96BT	96"
CRH07X97BT	97"
CRH07X98BT	98"
CRH07X99BT	99"
CRH07X100BT	100"
CRH07X101BT	101"
CRH07X102BT	102"
CRH07X103BT	103"
CRH07X104BT	104"
CRH07X105BT	105"
CRH07X106BT	106"
CRH07X107BT	107"
CRH07X108BT	108"

**we can do larger,
call for more information.**

7" TRADITIONAL WINDOW & DOOR CROSSHEAD

with bottom trim

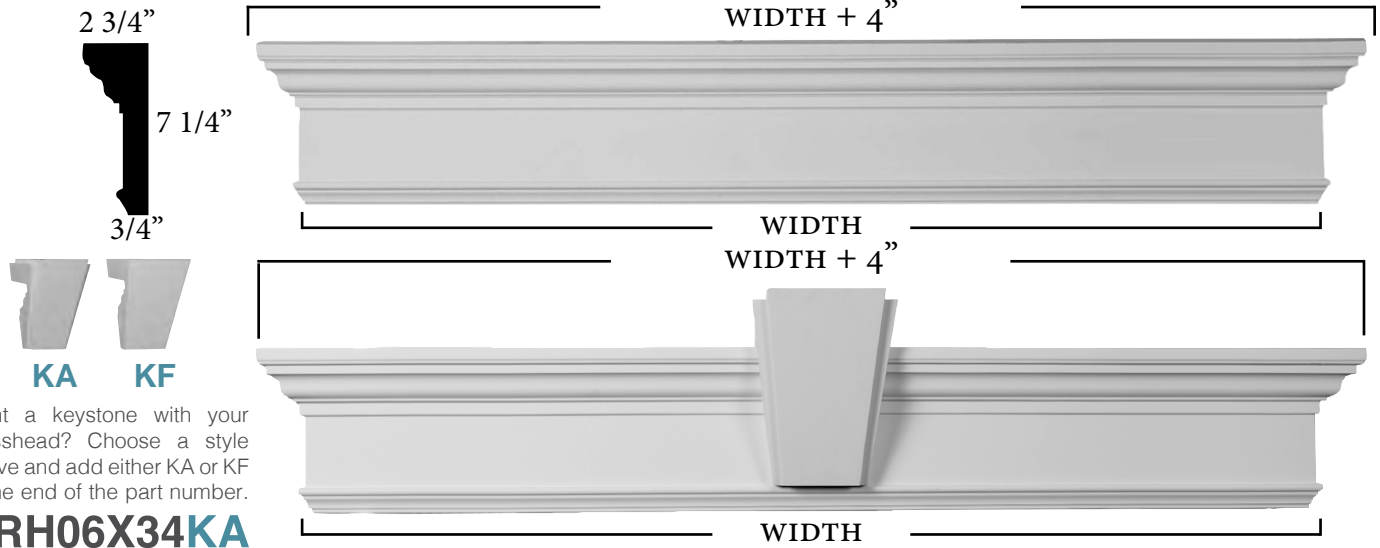

KA

KF

Want a keystone with your crosshead? Choose a style above and add either KA or KF to the end of the part number.

CRH06X34KA

Part Number	Width
CRH07X24	24"
CRH07X25	25"
CRH07X26	26"
CRH07X27	27"
CRH07X28	28"
CRH07X29	29"
CRH07X30	30"
CRH07X31	31"
CRH07X32	32"
CRH07X33	33"
CRH07X34	34"
CRH07X35	35"
CRH07X36	36"
CRH07X37	37"
CRH07X38	38"
CRH07X39	39"
CRH07X40	40"
CRH07X41	41"
CRH07X42	42"
CRH07X43	43"
CRH07X44	44"
CRH07X45	45"
CRH07X46	46"
CRH07X47	47"
CRH07X48	48"
CRH07X49	49"
CRH07X50	50"
CRH07X51	51"
CRH07X52	52"

Part Number	Width
CRH07X53	53"
CRH07X54	54"
CRH07X55	55"
CRH07X56	56"
CRH07X57	57"
CRH07X58	58"
CRH07X59	59"
CRH07X60	60"
CRH07X61	61"
CRH07X62	62"
CRH07X63	63"
CRH07X64	64"
CRH07X65	65"
CRH07X66	66"
CRH07X67	67"
CRH07X68	68"
CRH07X69	69"
CRH07X70	70"
CRH07X71	71"
CRH07X72	72"
CRH07X73	73"
CRH07X74	74"
CRH07X75	75"
CRH07X76	76"
CRH07X77	77"
CRH07X78	78"
CRH07X79	79"
CRH07X80	80"
CRH07X81	81"

Part Number	Width
CRH07X82	82"
CRH07X83	83"
CRH07X84	84"
CRH07X85	85"
CRH07X86	86"
CRH07X87	87"
CRH07X88	88"
CRH07X89	89"
CRH07X90	90"
CRH07X91	91"
CRH07X92	92"
CRH07X93	93"
CRH07X94	94"
CRH07X95	95"
CRH07X96	96"
CRH07X97	97"
CRH07X98	98"
CRH07X99	99"
CRH07X100	100"
CRH07X101	101"
CRH07X102	102"
CRH07X103	103"
CRH07X104	104"
CRH07X105	105"
CRH07X106	106"
CRH07X107	107"
CRH07X108	108"

we can do larger,
call for more information.

9" TRADITIONAL WINDOW & DOOR CROSSHEAD

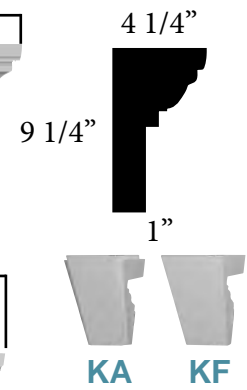
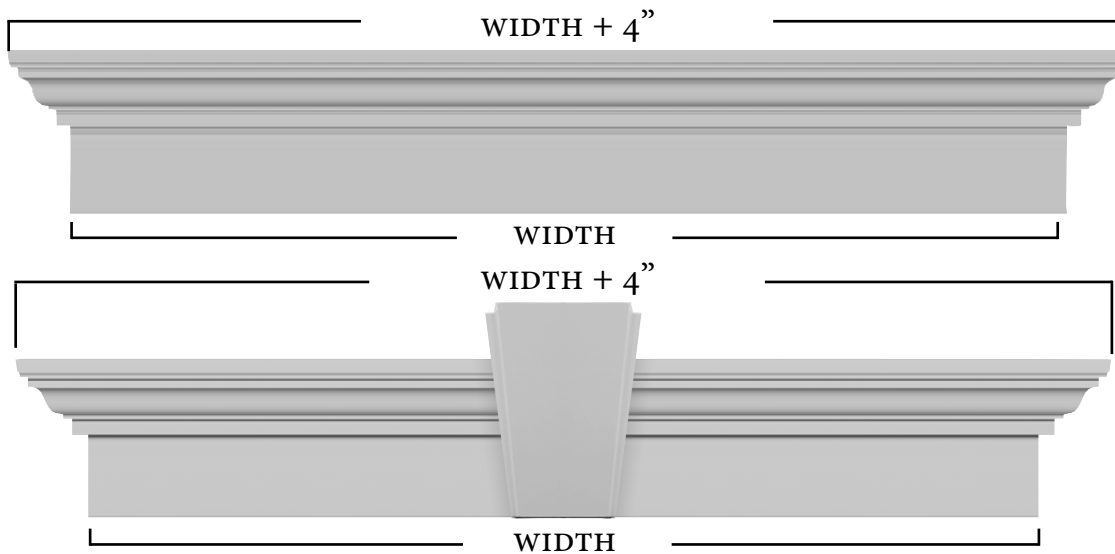

Want a keystone with your crosshead? Choose a style above and add either KA or KF to the end of the part number.

CRH06X34KA

Part Number	Width
CRH09X24	24"
CRH09X25	25"
CRH09X26	26"
CRH09X27	27"
CRH09X28	28"
CRH09X29	29"
CRH09X30	30"
CRH09X31	31"
CRH09X32	32"
CRH09X33	33"
CRH09X34	34"
CRH09X35	35"
CRH09X36	36"
CRH09X37	37"
CRH09X38	38"
CRH09X39	39"
CRH09X40	40"
CRH09X41	41"
CRH09X42	42"
CRH09X43	43"
CRH09X44	44"
CRH09X45	45"
CRH09X46	46"
CRH09X47	47"
CRH09X48	48"
CRH09X49	49"
CRH09X50	50"
CRH09X51	51"
CRH09X52	52"

Part Number	Width
CRH09X53	53"
CRH09X54	54"
CRH09X55	55"
CRH09X56	56"
CRH09X57	57"
CRH09X58	58"
CRH09X59	59"
CRH09X60	60"
CRH09X61	61"
CRH09X62	62"
CRH09X63	63"
CRH09X64	64"
CRH09X65	65"
CRH09X66	66"
CRH09X67	67"
CRH09X68	68"
CRH09X69	69"
CRH09X70	70"
CRH09X71	71"
CRH09X72	72"
CRH09X73	73"
CRH09X74	74"
CRH09X75	75"
CRH09X76	76"
CRH09X77	77"
CRH09X78	78"
CRH09X79	79"
CRH09X80	80"
CRH09X81	81"

Part Number	Width
CRH09X82	82"
CRH09X83	83"
CRH09X84	84"
CRH09X85	85"
CRH09X86	86"
CRH09X87	87"
CRH09X88	88"
CRH09X89	89"
CRH09X90	90"
CRH09X91	91"
CRH09X92	92"
CRH09X93	93"
CRH09X94	94"
CRH09X95	95"
CRH09X96	96"
CRH09X97	97"
CRH09X98	98"
CRH09X99	99"
CRH09X100	100"
CRH09X101	101"
CRH09X102	102"
CRH09X103	103"
CRH09X104	104"

**we can do larger,
call for more information.**

12" TRADITIONAL WINDOW & DOOR CROSSHEAD

with bottom trim



KA KF

Want a keystone with your crosshead? Choose a style above and add either KA or KF to the end of the part number.

CRH06X34KA

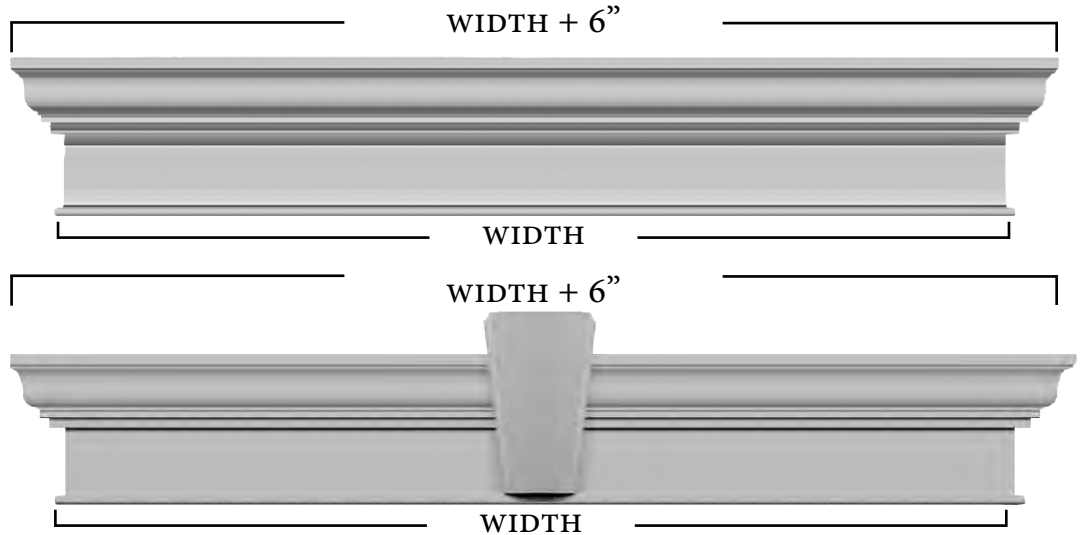

Part Number	Width
CRH12X24	24"
CRH12X25	25"
CRH12X26	26"
CRH12X27	27"
CRH12X28	28"
CRH12X29	29"
CRH12X30	30"
CRH12X31	31"
CRH12X32	32"
CRH12X33	33"
CRH12X34	34"
CRH12X35	35"
CRH12X36	36"
CRH12X37	37"
CRH12X38	38"
CRH12X39	39"
CRH12X40	40"
CRH12X41	41"
CRH12X42	42"
CRH12X43	43"
CRH12X44	44"
CRH12X45	45"
CRH12X46	46"
CRH12X47	47"
CRH12X48	48"
CRH12X49	49"
CRH12X50	50"
CRH12X51	51"
CRH12X52	52"

Part Number	Width
CRH12X53	53"
CRH12X54	54"
CRH12X55	55"
CRH12X56	56"
CRH12X57	57"
CRH12X58	58"
CRH12X59	59"
CRH12X60	60"
CRH12X61	61"
CRH12X62	62"
CRH12X63	63"
CRH12X64	64"
CRH12X65	65"
CRH12X66	66"
CRH12X67	67"
CRH12X68	68"
CRH12X69	69"
CRH12X70	70"
CRH12X71	71"
CRH12X72	72"
CRH12X73	73"
CRH12X74	74"
CRH12X75	75"
CRH12X76	76"
CRH12X77	77"
CRH12X78	78"
CRH12X79	79"
CRH12X80	80"
CRH12X81	81"

Part Number	Width
CRH12X82	82"
CRH12X83	83"
CRH12X84	84"
CRH12X85	85"
CRH12X86	86"
CRH12X87	87"
CRH12X88	88"
CRH12X89	89"
CRH12X90	90"
CRH12X91	91"
CRH12X92	92"
CRH12X93	93"
CRH12X94	94"
CRH12X95	95"
CRH12X96	96"
CRH12X97	97"
CRH12X98	98"
CRH12X99	99"
CRH12X100	100"

**we can do larger,
call for more information.**

9" FEDERAL WINDOW & DOOR CROSSHEAD

with dentil trim & panel

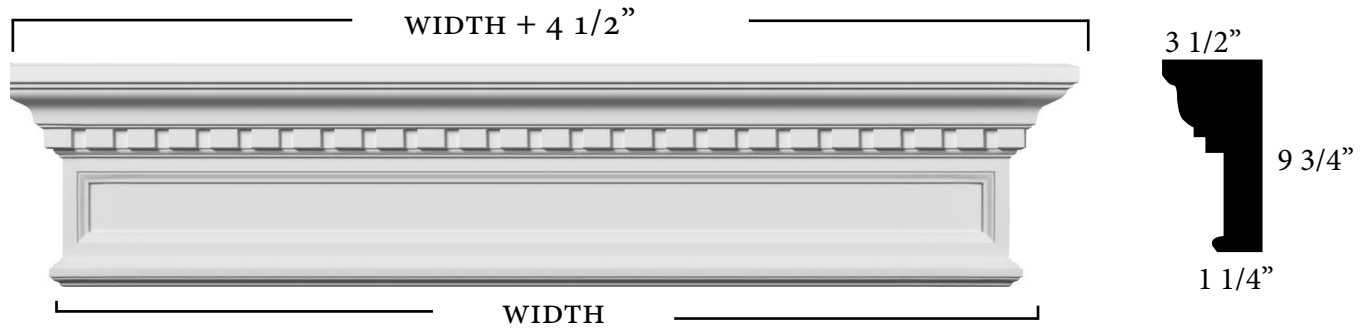

Part Number	Width
CRH09X44FE	44 7/8"

9" FEDERAL WINDOW & DOOR CROSSHEAD

with dentil trim

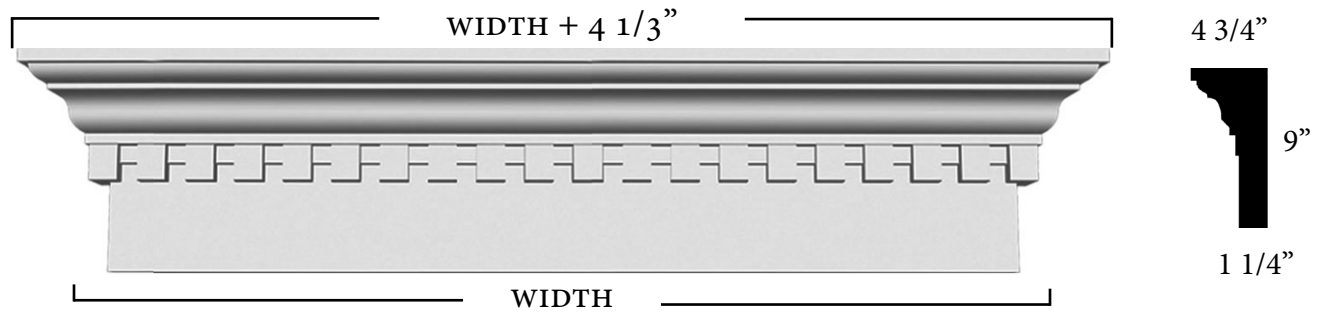

Part Number	Width
CRH09X54SE	54 7/8"
CRH09X68SE	68 3/4"

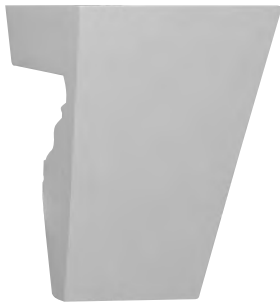

Product ID **W** **H** **P**
KEY05X06X04TR 5 3/4" 6 3/4" 4"
 for use with CRH07X



Product ID **W** **H** **P**
KEY05X07X04AM 5 3/4" 7 1/2" 4"
 for use with CRH07BTX



Product ID **W** **H** **P**
KEY05X08X04BA 5 3/4" 8" 4 5/8"
 for use with CRH07X



Product ID **W** **H** **P**
KEY05X08X04ST 5 3/4" 8" 4 5/8"
 for use with CRH07BTX



Product ID **W** **H** **P**
KEY06X07X04NE 6" 7 5/8" 4 5/8"
 for use with CRH06X



Product ID **W** **H** **P**
KEY06X07X04RI 6" 7" 4"
 for use with CRH06X

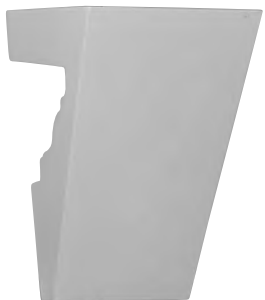

Product ID **W** **H** **P**
KEY08X11X06ED 8" 11" 6 1/4"
 for use with CRH09X



Product ID **W** **H** **P**
KEY08X11X06EL 8" 11 1/2" 6 7/8"
 for use with CRH09X



Product ID **W** **H** **P**
KEY08X13X08AS 8" 13 1/2" 8"
 for use with CRH12X



Product ID **W** **H** **P**
KEY08X14X08CH 8" 14" 8 1/2"
 for use with CRH12X

PEDIMENTS



HALF ROUND SUNBURST

Product ID	W	H	P
PED31X16X01SB	31 3/4"	16"	1 3/4"



HALF ROUND SUNBURST

Product ID	W	H	P
PED36X18X02SB	36"	18"	2"



HALF ROUND SPOKED

Product ID	W	H	P
PED36X18X02SP	36"	18"	2"



ELLIPTICAL SUNBURST

Product ID	W	H	P
PED40X09X01SE	40"	9"	1 3/4"



HALF ROUND SUNBURST

Product ID	W	H	P
PED40X18X01SB	40"	18 1/8"	1 3/4"



HALF ROUND SUNBURST

Product ID	W	H	P
PED40X20X02SB	40"	20"	2"



COMBINATION PEAKED CAP

Product ID	W	H	P
PED43X14X02PC	43 7/8"	14 1/8"	2 3/8"



EMERY

Product ID	W	H	P
PED45X14X01EM	45 1/2"	14 3/4"	1 1/8"



ELLIPTICAL SUNBURST

Product ID	W	H	P
PED48X11X02SB	48"	11"	2"



HALF ROUND SUNBURST

Product ID	W	H	P
PED48X24X02SB	48"	24"	2"



PEAKED CAP WITH FLANKERS

Product ID	W	H	P
PED52X16X02PF	52 1/8"	16"	2 3/8"



EMERY

Product ID	W	H	P
PED57X14X01EM	57 1/2"	14 7/8"	1 1/8"



PITCH ACORN

Product ID	W	H	P
PED57X16X04	55 5/8"	12 7/8"	4 1/2"



PEAKED CAP URN

Product ID	W	H	P
PED61X20X00UC	61"	20"	5/8"



PEAKED URN

Product ID	W	H	P
PED61X20X00UP	61"	20"	7/8"



SCROLL URN

Product ID	W	H	P
PED62X20X00US	62 3/8"	20"	5/8"



ELLIPTICAL SUNBURST WITH TRIM

Product ID	W	H	P
PED68X17X06ST	68 1/8"	17 3/8"	6 1/8"



ELLIPTICAL SUNBURST

Product ID	W	H	P
PED72X14X02SB	72"	14"	2"



FLUTED
Pair

Product ID
PIL05X90X02-2

Dimensions

W · 5"
H · 90"
P · 2"
P-H · 16"



FLUTED
Pair

Product ID
PIL05X96X02-2

Dimensions

W · 5"
H · 96"
P · 2"
P-H · 16"



FLUTED
Pair

Product ID
PIL06X104X02-2

Dimensions

W · 6"
H · 104"
P · 2 1/4"
P-H · 16"



FLUTED
Pair

Product ID
PIL07X08X02-2

Dimensions

W · 7"
H · 108"
P · 2 1/4"
P-H · 16"

**PAIR PILASTERS
WITH PEDIMENTS
TO CREATE
ARCHITECTURAL
INTEREST.**



FLUTED
Pair

Product ID
PIL07X90X02-2

Dimensions

W · 7"
H · 90"
P · 2 1/4"
P-H · 16"



DOUBLE PANEL
Pair

Product ID
PIL07X90X02DP-2

Dimensions

W · 7"
H · 90 1/2"
P · 2 3/8"
P-H · 16"



FLUTED
Pair

Product ID
PIL07X96X02-2

Dimensions

W · 7"
H · 96"
P · 2 1/4"
P-H · 16"



FLUTED
Pair

Product ID
PIL08X100X02-2

Dimensions

W · 8"
H · 100"
P · 2 3/4"
P-H · 14"



DOUBLE PANEL
Pair

Product ID
PIL08X96X02DP-2

Dimensions

W · 8"
H · 96"
P · 2 3/4"
P-H · 16"

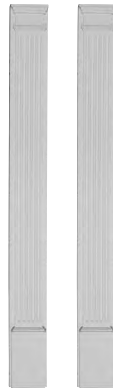

FLUTED
Pair

Product ID
PIL09X90X02-2

Dimensions

W · 9"
H · 90"
P · 2 3/4"
P-H · 16"



FLUTED
Pair

Product ID
PIL09X90X02-2

Dimensions

W · 8"
H · 108"
P · 2 3/4"
P-H · 16"



Product ID
CAS04X94X01

W · 3 3/4"
H · 94 1/2"
P · 7/8"

**USE
CASING AS
PILASTERS!**

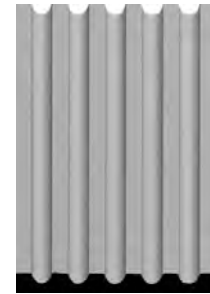

Product ID
CAS05X79X01

W · 5 1/8"
H · 78 3/4"
P · 5/8"

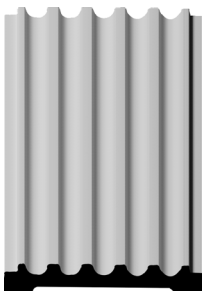

Product ID
CASQ7X79X01

W · 7"
H · 78 3/4"
P · 1"

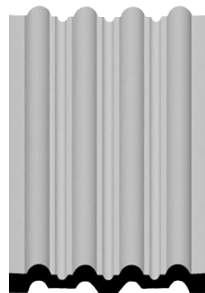

Product ID
CAS08X94X01

W · 7 7/8"
H · 94 1/2"
P · 1 1/8"

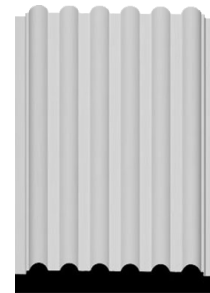

Product ID
CAS10X79X01

W · 9 1/2"
H · 78 3/4"
P · 1 3/8"



Product ID
CAS13X79X01

W · 12 5/8"
H · 78 3/4"
P · 1 1/8"



Product ID
CAS15X79X02

W · 15"
H · 78 3/4"
P · 1 7/8"

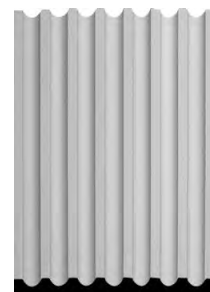

Product ID
CAS18X94X02

W · 17 3/4"
H · 94 1/2"
P · 1 1/2"

CAPITALS



CHESTERFIELD

Product ID

CAP08X05X02CH



D • 2 1/8"
H • 5 5/8"
W • 9 1/8"
B-W • 3 5/8"
B-D • 3/4"

CORINTHIAN

Product ID

CAP06X05X02RC



D • 1 3/4"
H • 5 1/8"
W • 5 3/4"
B-W • 4 1/8"
B-D • 1 3/8"

CORINTHIAN



Product ID

CAP07X06X02RC

D • 1 3/4"
H • 6 3/8"
W • 7"
B-W • 4 3/8"
B-D • 7/8"

ODESSA



Product ID

CAP08X02X05OD

D • 2 1/8"
H • 5 1/2"
W • 8 3/8"
B-W • 5 1/8"
B-D • 1/2"

ACANTHUS LEAF



Product ID

CAP08X05X02AC

D • 2 3/8"
H • 5 1/2"
W • 8 5/8"
B-W • 5 1/4"
B-D • 3/4"

TRADITIONAL



Product ID

CAP08X07X02TR

D • 2"
H • 7 7/8"
W • 8 1/8"
B-W • 5 3/8"
B-D • 3/4"

CORINTHIAN



Product ID

CAP08X07X03RC

D • 2 1/2"
H • 7 1/4"
W • 8 5/8"
B-W • 5 5/8"
B-D • 3/4"

CLASSIC



Product ID

CAP09X07X03RI

D • 2 1/2"
H • 8 1/2"
W • 7 1/2"
B-W • 5 5/8"
B-D • 1 1/8"

**PAIR THESE CAPITALS
 WITH PILASTERS FOR
 A UNIQUE ENTRY WAY!**

CAPITALS

ARTIS



Product ID

CAP07X01X07AR

D • 1 7/8"
H • 7 1/2"
W • 8 1/4"
B-W • 5 3/4"
B-D • 3/4"

CLASSIC ICONIC



Product ID

CAP08X07X02CL

D • 1 3/4"
H • 7 7/8"
W • 8 1/4"
B-W • 5 3/4"
B-D • 3/4"

ARTIS



Product ID

D • 2 1/2"
H • 8 5/8"
W • 7 1/2"
B-W • 5 3/4"
B-D • 1 1/8"

CLASSIC



Product ID

CAP07X10X03RI

D • 2 5/8"
H • 7 1/2"
W • 10 3/8"
B-W • 5 7/8"
B-D • 1 1/8"

SOUTHAMPTON



Product ID

CAP09X03X02SO

D • 2 1/4"
H • 3 1/8"
W • 9 1/4"
B-W • 6 1/8"
B-D • 1 3/8"

ACANTHUS LEAF



Product ID

CAP10X06X03AC

D • 2 3/4"
H • 6 1/8"
W • 10 1/2"
B-W • 6 1/8"
B-D • 1"

CLASSIC



Product ID

CAP13X09X06CL

D • 3 7/8"
H • 8 7/8"
W • 13"
B-W • 7"
B-D • 1"

SOUTHAMPTON



Product ID

CAP10X03X02SO

D • 2 1/8"
H • 2 7/8"
W • 10 1/4"
B-W • 7 1/8"
B-D • 1"

ACANTHUS LEAF



Product ID

CAP12X06X03AC

- D • 3 1/2"
- H • 6 7/8"
- W • 12 1/8"
- B-W • 7 1/4"
- B-D • 1"

TEMPLE OF WINDS



Product ID

CAP11X08X03TW

- D • 2 3/4"
- H • 7 5/8"
- W • 10 3/4"
- B-W • 7 3/8"
- B-D • 1 1/8"

ARTIS



Product ID

CAP07X10X03AR

- D • 2 5/8"
- H • 7 1/2"
- W • 10 3/8"
- B-W • 7 7/8"
- B-D • 1 1/2"

SMALL EMPIRE



Product ID

CAP16X10X04EM

- D • 10 3/8"
- H • 10 1/4"
- W • 16 7/8"
- B-W • 7 7/8"
- B-D • 7/8"

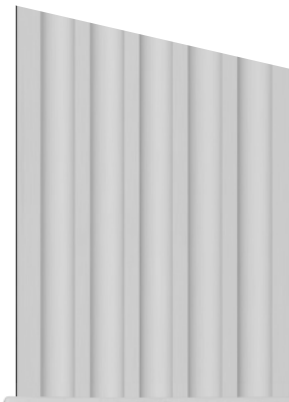
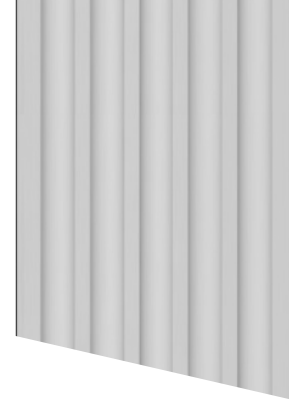

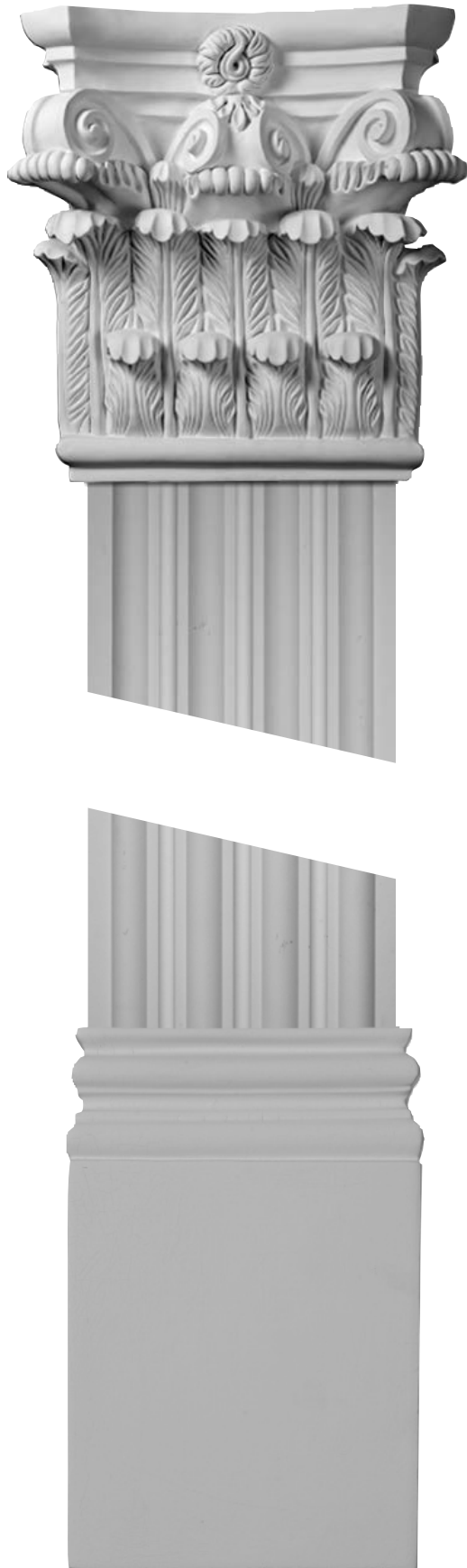

ANTHONY



Product ID

CAP11X07X11AT

D • 3 1/2"
H • 10"
W • 11 5/8"
B-W • 8"
B-D • 1 1/2"

ACANTHUS LEAF



Product ID

CAP17X11X05AC

D • 5 1/4"
H • 11 7/8"
W • 17 1/2"
B-W • 9 5/8"
B-D • 2"

KENDALL



Product ID

CAP19X06X14KD

D • 6 1/4"
H • 14 3/8"
W • 19 1/4"
B-W • 10 1/4"
B-D • 1 1/4"

ACANTHUS



Product ID

CAP14X16X04AC

D • 3 3/4"
H • 13 5/8"
W • 16 1/2"
B-W • 10 5/8"
B-D • 7/8"

LARGE EMPIRE



Product ID

CAP19X13X05EM

D . 4 7/8"
 H . 13 3/8"
 W . 19 5/8"
 B-W . 10 5/8"
 B-D . 7/8"

ANGEL



Product ID

CAP14X16X04AN

D . 3 7/8"
 H . 13 5/8"
 W . 16 3/8"
 B-W . 10 7/8"
 B-D . 1"

ACANTHUS LEAF



Product ID

CAP24X15X06AC

D . 6 3/4"
 H . 15 3/4"
 W . 24"
 B-W . 11 3/4"
 B-D . 2"

SUSSEX



Product ID

CAP21X07X16SU

D . 7 7/8"
 H . 17 1/8"
 W . 21 5/8"
 B-W . 13 3/4"
 B-D . 1 3/4"

VICTORIAN



Product ID

CAP24X17X06VI

D . 5 7/8"
 H . 16 3/4"
 W . 24"
 B-W . 16 1/8"
 B-D . 2 1/4"

CORINTHIAN



Product ID

CAP25X25X08RC

D . 8 1/4"
 H . 26 1/8"
 W . 25 1/4"
 B-W . 19 1/4"
 B-D . 2 1/2"



partnering with contractors, installers, designers, & architects

DEPTH | WIDTH | HEIGHT | BOTTOM-WIDTH | BOTTOM-DEPTH

PLINTHS & BASES



PLINTHS & BASES

CLASSIC



Product ID
BAS10X17X02CL

Dimensions

W • 10 7/8"

H • 17 3/4"

P • 2 1/2"

Top P • 1"

Top W • 8 1/8"

CLASSIC



Product ID
BAS14X24X02CL

Dimensions

W • 14 3/8"

H • 24 3/4"

P • 3"

Top P • 1"

Top W • 11"

GIANA



Product ID
PB03X07X01GI

Dimensions

W • 3 3/4"

H • 7"

P • 1 1/8"

BRADFORD



Product ID
PB04X09X01BR

Dimensions

W • 4 3/8"

H • 9 1/8"

P • 1 1/8"

PALMETTO



Product ID
PB04X06X01PM

Dimensions

W • 4 1/8"

H • 6 3/4"

P • 1"

JEFFERSON



Product ID
PB04X09X01JE

Dimensions

W • 4 1/8"

H • 9"

P • 1 1/8"

DEVON



Product ID
PB04X11X01DE

Dimensions

W • 4 1/2"

H • 11 3/4"

P • 1 1/4"

BRADFORD



Product ID
PB04X07X01BR

Dimensions

W • 4 3/4"

H • 7 3/4"

P • 1"

MEDWAY



Product ID
PB04X07X01BR

Dimensions

W • 5 1/4"

H • 8 5/8"

P • 1 1/4"

ADONIS



Product ID
PB05X09X01AD

Dimensions

W • 5 3/4"

H • 9 3/8"

P • 1"

DIANE



Product ID
PB06X09X01DI

Dimensions

W • 6 1/4"

H • 9 3/4"

P • 1"



PLINTHS & BASES



KENT

Product ID W H P
 PB03X03X01KE 3 3/4" 3 3/4" 1 3/8"



BENSON

Product ID W H P
 PB03X03BE 3 7/8" 3 7/8" 1 1/2"



LYON

Product ID W H P
 PB03X03X01LY 3 7/8" 3 7/8" 1 1/8"



FLOWER

Product ID W H P
 PB03X04FL 3 7/8" 3 7/8" 3/4"

CAPITALS PILASTERS BASES



EMERY

Product ID W H P
 PB04X04X01EM 4 1/8" 4 1/8" 1"



NEXUS

Product ID W H P
 PB04X04X01NE 4 1/4" 4 1/4" 1 1/8"



REECE

Product ID W H P
 PB04X04X01RE 4 1/4" 4 1/4" 1 5/8"



COLE

Product ID W H P
 PB04X04CO 4 3/8" 4 3/8" 1"



WALTZ

Product ID W H P
 PB04X04X01WA 4 3/4" 4 3/4" 1 1/8"



ODESSA

Product ID W H P
 PB05X05X01OD 5 1/4" 5 1/4" 1 1/4"



NEXUS

Product ID	W	H	P
PB02X02NE	2 1/4"	2 1/4"	1 1/8"



MARIA

Product ID	W	H	P
PB02X02X01MA	2 3/8"	2 3/8"	1"



DEVON

Product ID	W	H	P
PB03X03X01DE	3 1/4"	3 1/4"	1 1/8"

THE PERFECT ENTRY WAY.



FLORAL

Product ID	W	H	P
PB03X03FL	3 1/2"	3 1/2"	1 1/4"



ERIS

Product ID	W	H	P
PB03X03X01ER	3 3/4"	3 3/4"	1 1/8"



ANTHONY

Product ID	W	H	P
PB03X03AT	3 3/4"	3 3/4"	1 3/8"



HELENE

Product ID	W	H	P
PB03X03X01HE	3 3/4"	3 3/4"	1 1/2"



REECE

Product ID	W	H	P
PB05X05X01RE	5 3/8"	5 3/8"	1 3/4"



TRADITIONAL

Product ID	W	H	P
PB05X05X01TR	5 3/4"	5 3/4"	1 1/8"

URETHANE GABLE VENTS



URETHANE GABLE VENTS

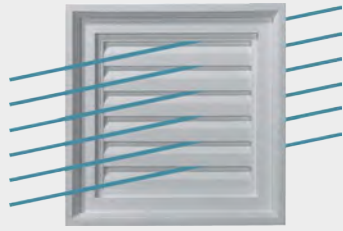

FUNCTIONAL

allows airflow to pass through the vent



DECORATIVE

same look without the airflow



Eyebrow Gable Vents

Part #	Type	W x H
GVEY12X16	D / F	12" x 16"
GVEY12X18	D / F	12" x 18"
GVEY12X20	D / F	12" x 20"
GVEY12X22	D / F	12" x 22"
GVEY12X24*	D / F	12" x 24"
GVEY18X16	D / F	18" x 16"
GVEY18X18	D / F	18" x 18"
GVEY18X20	D / F	18" x 20"
GVEY18X22	D / F	18" x 22"
GVEY18X24	D / F	18" x 24"
GVEY18X26	D / F	18" x 26"
GVEY18X28	D / F	18" x 28"
GVEY18X30*	D / F	18" x 30"

Peaked Top Gable Vents

Part #	Type	W x H
GVPE12X18	D / F	12" x 18"
GVPE12X20	D / F	12" x 20"
GVPE12X22	D / F	12" x 22"
GVPE12X24	D / F	12" x 24"
GVPE12X26	D / F	12" x 26"
GVPE12X28	D / F	12" x 28"
GVPE12X30	D / F	12" x 30"
GVPE12X32*	D / F	12" x 32"
GVPE24X18	D / F	24" x 18"
GVPE24X20	D / F	24" x 20"
GVPE24X22	D / F	24" x 22"
GVPE24X24	D / F	24" x 24"
GVPE24X26	D / F	24" x 26"
GVPE24X28	D / F	24" x 28"
GVPE24X30*	D / F	24" x 30"
GVPE24X32	D / F	24" x 32"
GVPE24X34	D / F	24" x 34"
GVPE24X36*	D / F	24" x 36"
GVPE24X38	D / F	24" x 38"
GVPE24X40	D / F	24" x 40"
GVPE24X42	D / F	24" x 42"
GVPE24X44	D / F	24" x 44"
GVPE24X46	D / F	24" x 46"
GVPE24X48	D / F	24" x 48"
GVPE24X50	D / F	24" x 50"
GVPE24X52	D / F	24" x 52"
GVPE24X54*	D / F	24" x 54"

URETHANE GABLE VENTS



Vertical Gable Vents		
Part #	Type	W x H
GVVE12X12	D / F	12" x 12"
GVVE12X14	D / F	12" x 14"
GVVE12X16	D / F	12" x 16"
GVVE12X18*	D / F	12" x 18"
GVVE12X20	D / F	12" x 20"
GVVE12X22	D / F	12" x 22"
GVVE12X24*	D / F	12" x 24"
GVVE12X26	D / F	12" x 26"
GVVE12X28	D / F	12" x 28"
GVVE12X30	D / F	12" x 30"
GVVE12X32	D / F	12" x 32"
GVVE12X34	D / F	12" x 34"
GVVE12X36*	D / F	12" x 36"
GVVE15X12	D / F	15" x 12"
GVVE15X14	D / F	15" x 14"
GVVE15X15*	D / F	15" x 15"
GVVE15X16	D / F	15" x 16"
GVVE15X18	D / F	15" x 18"
GVVE15X20	D / F	15" x 20"
GVVE15X22	D / F	15" x 22"
GVVE15X24	D / F	15" x 24"
GVVE15X26	D / F	15" x 26"
GVVE15X28	D / F	15" x 28"
GVVE15X30*	D / F	15" x 30"
GVVE16X12	D / F	16" x 12"
GVVE16X14	D / F	16" x 14"
GVVE16X16	D / F	16" x 16"

Vertical Gable Vents		
Part #	Type	W x H
GVVE16X18	D / F	16" x 18"
GVVE16X20	D / F	16" x 20"
GVVE16X22	D / F	16" x 22"
GVVE16X24*	D / F	16" x 24"
GVVE16X26	D / F	16" x 26"
GVVE16X28	D / F	16" x 28"
GVVE16X30	D / F	16" x 30"
GVVE16X32	D / F	16" x 32"
GVVE16X34	D / F	16" x 34"
GVVE16X36*	D / F	16" x 36"
GVVE18X12	D / F	18" x 12"
GVVE18X14	D / F	18" x 14"
GVVE18X16	D / F	18" x 16"
GVVE18X18	D / F	18" x 18"
GVVE18X20	D / F	18" x 20"
GVVE18X22	D / F	18" x 22"
GVVE18X24*	D / F	18" x 24"
GVVE18X26	D / F	18" x 26"
GVVE18X28	D / F	18" x 28"
GVVE18X30*	D / F	18" x 30"
GVVE18X32	D / F	18" x 32"
GVVE18X34	D / F	18" x 34"
GVVE18X36*	D / F	18" x 36"
GVVE24X12	D / F	24" x 12"
GVVE24X14	D / F	24" x 14"
GVVE24X16	D / F	24" x 16"
GVVE24X18	D / F	24" x 18"
GVVE24X20	D / F	24" x 20"
GVVE24X22	D / F	24" x 22"
GVVE24X24	D / F	24" x 24"
GVVE24X26	D / F	24" x 26"
GVVE24X28	D / F	24" x 28"
GVVE24X30	D / F	24" x 30"
GVVE24X32	D / F	24" x 32"
GVVE24X34	D / F	24" x 34"
GVVE24X36*	D / F	24" x 36"

URETHANE GABLE VENTS



Cathedral Top Gable Vents

Part #	Type	W x H
GVCA12X16	D / F	12" x 16"
GVCA12X18	D / F	12" x 18"
GVCA12X20	D / F	12" x 20"
GVCA12X22	D / F	12" x 22"
GVCA12X24*	D / F	12" x 24"
GVCA14X24	D / F	14" x 24"
GVCA14X26	D / F	14" x 26"
GVCA14X28	D / F	14" x 28"
GVCA14X30	D / F	14" x 30"
GVCA14X32*	D / F	14" x 32"
GVCA16X28	D / F	16" x 28"
GVCA16X30	D / F	16" x 30"
GVCA16X32	D / F	16" x 32"
GVCA16X34	D / F	16" x 34"
GVCA16X36*	D / F	16" x 36"
GVCA18X22	D / F	18" x 22"
GVCA18X24	D / F	18" x 24"
GVCA18X26	D / F	18" x 26"
GVCA18X28	D / F	18" x 28"
GVCA18X30*	D / F	18" x 30"
GVCA22X24	D / F	22" x 24"
GVCA22X26	D / F	22" x 26"
GVCA22X28	D / F	22" x 28"
GVCA22X30	D / F	22" x 30"
GVCA22X32*	D / F	22" x 32"

Cathedral Top Gable Vents Trim

Part #	W x H	Inside W x H
GVCA12X24-16	30" x 41"	22" x 32"

ALL OF OUR URETHANE GABLE VENTS ARE
SURFACE MOUNT
 FOR EASY INSTALLATION

URETHANE GABLE VENTS



Round Gable Vents

Part #	Type	W x H
GVRO12	D / F	12"
GVRO16	D / F	16"
GVRO18	D / F	18"
GVRO22	D / F	22"
GVRO24	D / F	24"
GVRO28	D / F	28"
GVRO30	D / F	30"
GVRO36	D / F	36"

Half Round Gable Vents

Part #	Type	W x H
GVHR24	D / F	24" x 12"
GVHR28	D / F	28" x 14"
GVHR32	D / F	32" x 16"
GVHR36	D / F	36" x 18"
GVHR40	D / F	40" x 20"
GVHR48	D / F	48" x 24"
GVHR60	D / F	60" x 30"

Round Gable Vents (Wide Trim)

Part #	Type	W x H
GVRO20	D / F	20"
GVRO23	D / F	23"
GVRO27	D / F	27"

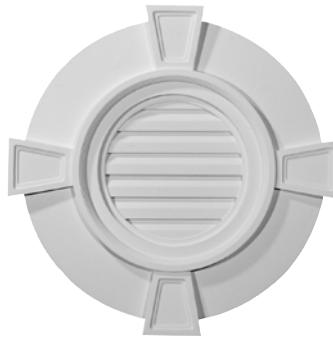

Oval Gable Vents with Keystones

Part #	Type	W x H
GVOV29X20	D / F	29" x 20"

Round Gable Vents with Keystones

Part #	Type	Diameter
GVRO24T*K	D / F	24"
GVRO30T*K	D / F	30"
GVRO36T*K	D / F	34 1/8"

Round Gable Vents with Keystones

Part #	Type	Diameter
GVRO22*K	D / F	22"
GVRO24*K	D / F	24"

URETHANE GABLE VENTS



Round Gable Vents Trim		
Part #	Outside	Inside
GVROT18	25 1/4"	18 1/4"
GVROT24	31"	24"
GVROT28	35"	28"



Oval Gable Vents		
Part #	Type	W x H
GVOV25X37*	D / F	24 1/2" x 37"

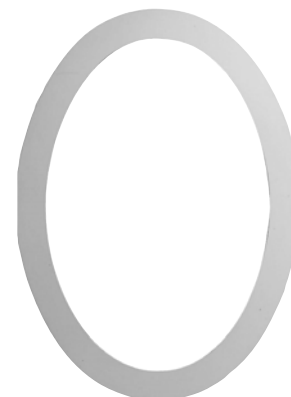

Oval Gable Vents Trim		
Part #	Outside W x H	Inside W x H
GVOVT32X44	32" x 44"	25" x 37"



Octagon Gable Vents		
Part #	Type	W x H
GVOC18X18	D / F	18"
GVOC22X22	D / F	22"
GVOC30X30	D / F	30"



Diamond Gable Vents		
Part #	Type	W x H
GVDI34X34*	D / F	34" x 34"



Triangle Gable Vents		
Part #	Type	W x H
GVTR48X20	D / F	48" x 20"
GVTR48X24	D / F	48" x 24"
GVTR65X21	D / F	65" x 21"
GVTR65X27	D / F	65" x 27"
GVTR65X32	D / F	65" x 32"
GVTR72X18	D / F	72" x 18"
GVTR72X21	D / F	72" x 21"

WOOD GABLE VENTS



WOOD GABLE VENTS

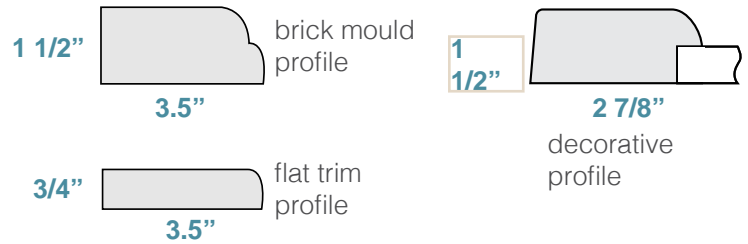

BRICK MOULD OR FLAT TRIM

All of our vents are available with either a brick mould frame or a standard 1"x4" flat trim. Brickmould is perfect for new construction or when you need to run siding up against the vent. For all other application, the 1"x4" trim will work perfectly for you.

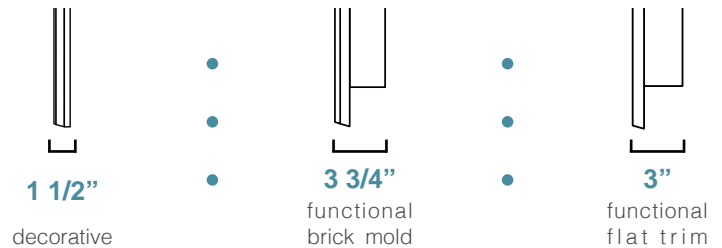

DECORATIVE OR FUNCTIONAL

All our vents are available as either a fully functional air-flow vent, or as a surface-mounted decorative vent. The louver boxes on our functional vents are designed to maximize air-flow while also protecting your attic from the natural elements. Decorative gable vents are designed to be non-functional, surface-mounted vents.

ROUGH SAWN SMOOTH

ROUGH SAWN OR SMOOTH

The smooth finish Cedar or Pine is milled to perfection in our state-of-the-art wood shop. The smooth finish vents are also the perfect option if you plan on painting them. The rough-sawn finish offers a natural rustic look. The rough sawn vents are timeless, offering the saw-textured surface obtained during the milling process that give you the look of freshly cut lumber.

WOOD SPECIES

We offer our vents in both traditional Pine or durable Cedar. All of our wood is carefully chosen and hand inspected before being assembled into your vent. After each vent is made, it is again inspected to ensure you receive only the highest quality product on the market.

UNFINISHED OR PRIMED

You have the choice of ordering an unfinished gable vent or a primed one. If you prefer the natural look of freshly cut wood, unfinished is for you. If you prefer to paint your vent, we will prime it for you with two coats of high quality exterior grade primer.

COMPONENTS OF PART NUMBER: **GVWVE12X1801RDUPI**



00 = brick mould face frame
01 = 1" x 4" flat trim frame

R = rough sawn
S = smooth

F = functional
D = decorative

U = Unfinished
P = Primed

PI = Pine
WR = Western Red Cedar

WOOD GABLE VENTS

VERTICAL Gable Vents



part number
GVWVE

Part Number	Rough Opening Dimensions	Part Number	Rough Opening Dimensions
GVWVE12X12	12"W x 12"H	GVWVE20X22	20"W x 22"H
GVWVE12X14	12"W x 14"H	GVWVE20X24	20"W x 24"H
GVWVE12X16	12"W x 16"H	GVWVE20X26	20"W x 26"H
GVWVE12X18	12"W x 18"H	GVWVE20X28	20"W x 28"H
GVWVE12X20	12"W x 20"H	GVWVE20X30	20"W x 30"H
GVWVE12X22	12"W x 22"H	GVWVE20X32	20"W x 32"H
GVWVE12X24	12"W x 24"H	GVWVE20X34	20"W x 34"H
GVWVE12X26	12"W x 26"H	GVWVE20X36	20"W x 36"H
GVWVE12X28	12"W x 28"H	GVWVE22X12	22"W x 12"H
GVWVE12X30	12"W x 30"H	GVWVE22X14	22"W x 14"H
GVWVE12X32	12"W x 32"H	GVWVE22X16	22"W x 16"H
GVWVE12X34	12"W x 34"H	GVWVE22X18	22"W x 18"H
GVWVE12X36	12"W x 36"H	GVWVE22X20	22"W x 20"H
GVWVE14X12	14"W x 12"H	GVWVE22X22	22"W x 22"H
GVWVE14X14	14"W x 14"H	GVWVE22X24	22"W x 24"H
GVWVE14X16	14"W x 16"H	GVWVE22X26	22"W x 26"H
GVWVE14X18	14"W x 18"H	GVWVE22X28	22"W x 28"H
GVWVE14X20	14"W x 20"H	GVWVE22X30	22"W x 30"H
GVWVE14X22	14"W x 22"H	GVWVE22X32	22"W x 32"H
		GVWVE22X34	22"W x 34"H
		GVWVE22X36	22"W x 36"H
		GVWVE24X12	24"W x 12"H
		GVWVE24X14	24"W x 14"H
		GVWVE24X16	24"W x 16"H
		GVWVE24X18	24"W x 18"H
		GVWVE24X20	24"W x 20"H
		GVWVE24X22	24"W x 22"H
		GVWVE24X24	24"W x 24"H
		GVWVE24X26	24"W x 26"H
		GVWVE24X28	24"W x 28"H
		GVWVE24X30	24"W x 30"H
		GVWVE24X32	24"W x 32"H
		GVWVE24X34	24"W x 34"H
		GVWVE24X36	24"W x 36"H
		GVWVE26X12	26"W x 12"H
		GVWVE26X14	26"W x 14"H
		GVWVE26X16	26"W x 16"H
		GVWVE26X18	26"W x 18"H

WOOD GABLE VENTS

Part Number	Rough Opening Dimensions	Part Number	Rough Opening Dimensions
GVWVE26X20	26"W x 20"H	GVWVE32X16	32"W x 16"H
GVWVE26X22	26"W x 22"H	GVWVE32X18	32"W x 18"H
GVWVE26X24	26"W x 24"H	GVWVE32X20	32"W x 20"H
GVWVE26X26	26"W x 26"H	GVWVE32X22	32"W x 22"H
GVWVE26X28	26"W x 28"H	GVWVE32X24	32"W x 24"H
GVWVE26X30	26"W x 30"H	GVWVE32X26	32"W x 26"H
GVWVE26X32	26"W x 32"H	GVWVE32X28	32"W x 28"H
GVWVE26X34	26"W x 34"H	GVWVE32X30	32"W x 30"H
GVWVE26X36	26"W x 36"H	GVWVE32X32	32"W x 32"H
GVWVE28X12	28"W x 12"H	GVWVE32X34	32"W x 34"H
GVWVE28X14	28"W x 14"H	GVWVE32X36	32"W x 36"H
GVWVE28X16	28"W x 16"H	GVWVE34X12	34"W x 12"H
GVWVE28X18	28"W x 18"H	GVWVE34X14	34"W x 14"H
GVWVE28X20	28"W x 20"H	GVWVE34X16	34"W x 16"H
GVWVE28X22	28"W x 22"H	GVWVE34X18	34"W x 18"H
GVWVE28X24	28"W x 24"H	GVWVE34X20	34"W x 20"H
GVWVE28X26	28"W x 26"H	GVWVE34X22	34"W x 22"H
GVWVE28X28	28"W x 28"H	GVWVE34X24	34"W x 24"H
GVWVE28X30	28"W x 30"H	GVWVE34X26	34"W x 26"H
GVWVE28X32	28"W x 32"H	GVWVE34X28	34"W x 28"H
GVWVE28X34	28"W x 34"H	GVWVE34X30	34"W x 30"H
GVWVE28X36	28"W x 36"H	GVWVE34X32	34"W x 32"H
GVWVE30X12	30"W x 12"H	GVWVE34X34	34"W x 34"H
GVWVE30X14	30"W x 14"H	GVWVE34X36	34"W x 36"H
GVWVE30X16	30"W x 16"H	GVWVE36X12	36"W x 12"H
GVWVE30X18	30"W x 18"H	GVWVE36X14	36"W x 14"H
GVWVE30X20	30"W x 20"H	GVWVE36X16	36"W x 16"H
GVWVE30X22	30"W x 22"H	GVWVE36X18	36"W x 18"H
GVWVE30X24	30"W x 24"H	GVWVE36X20	36"W x 20"H
GVWVE30X26	30"W x 26"H	GVWVE36X22	36"W x 22"H
GVWVE30X28	30"W x 28"H	GVWVE36X24	36"W x 24"H
GVWVE30X30	30"W x 30"H	GVWVE36X26	36"W x 26"H
GVWVE30X32	30"W x 32"H	GVWVE36X28	36"W x 28"H
GVWVE30X34	30"W x 34"H	GVWVE36X30	36"W x 30"H
GVWVE30X36	30"W x 36"H	GVWVE36X32	36"W x 32"H
GVWVE32X12	32"W x 12"H	GVWVE36X34	36"W x 34"H
GVWVE32X14	32"W x 14"H	GVWVE36X36	36"W x 36"H

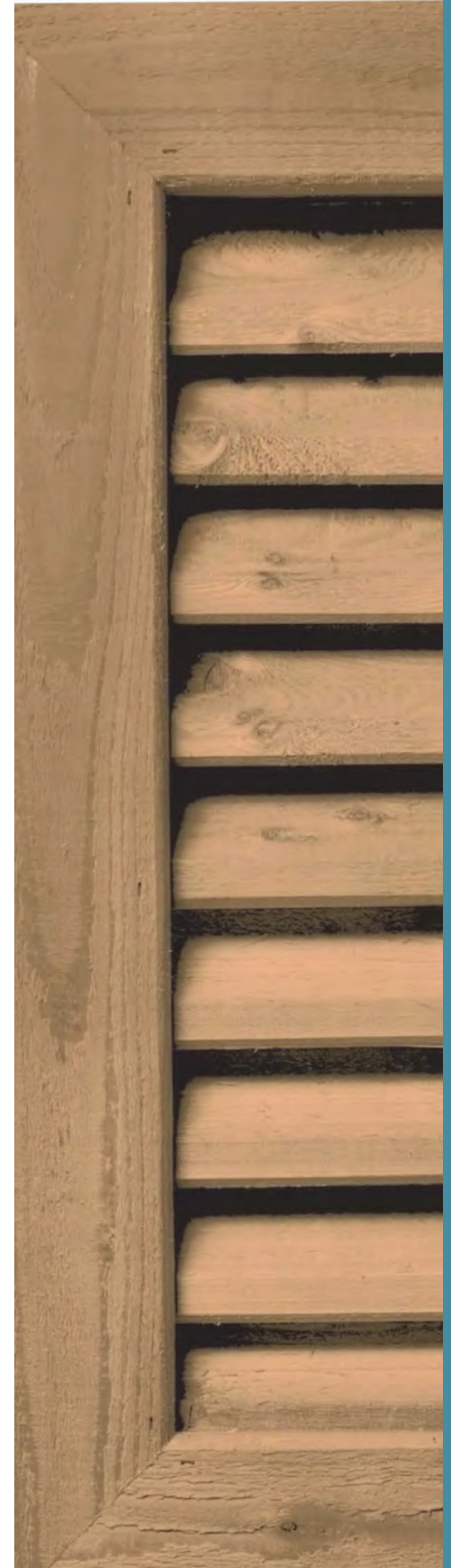

WOOD GABLE VENTS

Peaked Top Gable Vents

part number

GVWPE



Part Number	Rough Opening Dimensions	Part Number	Rough Opening Dimensions
GVWPE12X12	12"W x 12"H	GVWPE24X30	24"W x 30"H
GVWPE12X14	12"W x 14"H	GVWPE24X32	24"W x 32"H
GVWPE12X16	12"W x 16"H	GVWPE24X34	24"W x 34"H
GVWPE12X18	12"W x 18"H	GVWPE24X36	24"W x 36"H
GVWPE12X20	12"W x 20"H	GVWPE26X24	26"W x 24"H
GVWPE12X22	12"W x 22"H	GVWPE26X26	26"W x 26"H
GVWPE12X24	12"W x 24"H	GVWPE26X28	26"W x 28"H
GVWPE12X26	12"W x 26"H	GVWPE26X30	26"W x 30"H
GVWPE12X28	12"W x 28"H	GVWPE26X32	26"W x 32"H
GVWPE12X30	12"W x 30"H	GVWPE26X34	26"W x 34"H
GVWPE12X32	12"W x 32"H	GVWPE26X36	26"W x 36"H
GVWPE12X34	12"W x 34"H	GVWPE28X24	28"W x 24"H
GVWPE12X36	12"W x 36"H	GVWPE28X26	28"W x 26"H
GVWPE14X14	14"W x 14"H	GVWPE28X28	28"W x 28"H
GVWPE14X16	14"W x 16"H	GVWPE28X30	28"W x 30"H
GVWPE14X18	14"W x 18"H	GVWPE28X32	28"W x 32"H
GVWPE14X20	14"W x 20"H	GVWPE28X34	28"W x 34"H
GVWPE14X22	14"W x 22"H	GVWPE28X36	28"W x 36"H
GVWPE14X24	14"W x 24"H	GVWPE30X24	30"W x 24"H
GVWPE14X26	14"W x 26"H	GVWPE30X26	30"W x 26"H
GVWPE14X28	14"W x 28"H	GVWPE30X28	30"W x 28"H
GVWPE14X30	14"W x 30"H	GVWPE30X30	30"W x 30"H
GVWPE14X32	14"W x 32"H	GVWPE30X32	30"W x 32"H
GVWPE14X34	14"W x 34"H	GVWPE30X34	30"W x 34"H
GVWPE14X36	14"W x 36"H	GVWPE30X36	30"W x 36"H
GVWPE16X16	16"W x 16"H	GVWPE32X24	32"W x 24"H
GVWPE16X18	16"W x 18"H	GVWPE32X26	32"W x 26"H
		GVWPE32X28	32"W x 28"H
		GVWPE32X30	32"W x 30"H
		GVWPE32X32	32"W x 32"H
		GVWPE32X34	32"W x 34"H
		GVWPE32X36	32"W x 36"H
		GVWPE34X24	34"W x 24"H
		GVWPE34X26	34"W x 26"H
		GVWPE34X28	34"W x 28"H
		GVWPE34X30	34"W x 30"H
		GVWPE34X32	34"W x 32"H
		GVWPE34X34	34"W x 34"H
		GVWPE34X36	34"W x 36"H

Triangle Gable Vents



part number
GVWTR

Part Number	Rough Opening Dimensions	Pitch
GVWTR36X07	36"W x 7-1/2"H	5/12
GVWTR36X09	36"W x 9"H	6/12
GVWTR36X10	36"W x 10-1/2"H	7/12
GVWTR36X12	36"W x 12"H	8/12
GVWTR36X14	36"W x 13-1/2"H	9/12
GVWTR36X15	36"W x 15"H	10/12
GVWTR36X16	36"W x 16-1/2"H	11/12
GVWTR36X18	36"W x 18"H	12/12
GVWTR40X08	40"W x 8-3/8"H	5/12
GVWTR40X10	40"W x 10"H	6/12
GVWTR40X11	40"W x 11-5/8"H	7/12
GVWTR40X13	40"W x 13-3/8"H	8/12
GVWTR40X15	40"W x 15"H	9/12
GVWTR40X16	40"W x 16-5/8"H	10/12
GVWTR40X18	40"W x 18-3/8"H	11/12
GVWTR40X20	40"W x 20"H	12/12
GVWTR44X09	44"W x 9-1/8"H	5/12
GVWTR44X11	44"W x 11"H	6/12
GVWTR44X12	44"W x 12-3/4"H	7/12
GVWTR44X14	44"W x 14-5/8"H	8/12
GVWTR44X16	44"W x 16-1/2"H	9/12
GVWTR44X18	44"W x 18-3/8"H	10/12
GVWTR44X20	44"W x 20-1/8"H	11/12
GVWTR44X22	44"W x 22"H	12/12
GVWTR48X10	48"W x 10"H	5/12
GVWTR48X12	48"W x 12"H	6/12
GVWTR48X14	48"W x 14"H	7/12

Part Number	Rough Opening Dimensions	Pitch
GVWTR48X16	48"W x 16"H	8/12
GVWTR48X18	48"W x 18"H	9/12
GVWTR48X20	48"W x 20"H	10/12
GVWTR48X22	48"W x 22"H	11/12
GVWTR48X24	48"W x 24"H	12/12
GVWTR52X10	52"W x 10-3/4"H	5/12
GVWTR52X13	52"W x 13"H	6/12
GVWTR52X15	52"W x 15-1/8"H	7/12
GVWTR52X17	52"W x 17-3/8"H	8/12
GVWTR52X19	52"W x 19-1/2"H	9/12
GVWTR52X21	52"W x 21-5/8"H	10/12
GVWTR52X23	52"W x 23-3/4"H	11/12
GVWTR52X26	52"W x 26"H	12/12
GVWTR56X11	56"W x 11-5/8"H	5/12
GVWTR56X14	56"W x 14"H	6/12
GVWTR56X16	56"W x 16-3/8"H	7/12
GVWTR56X18	56"W x 18-5/8"H	8/12
GVWTR56X21	56"W x 21"H	9/12
GVWTR56X23	56"W x 23-3/8"H	10/12
GVWTR56X25	56"W x 25-5/8"H	11/12
GVWTR56X28	56"W x 28"H	12/12
GVWTR60X12	60"W x 12-1/2"H	5/12
GVWTR60X15	60"W x 15"H	6/12
GVWTR60X17	60"W x 17-1/2"H	7/12
GVWTR60X20	60"W x 20"H	8/12
GVWTR60X22	60"W x 22-1/2"H	9/12
GVWTR60X25	60"W x 25"H	10/12
GVWTR60X27	60"W x 27-1/2"H	11/12
GVWTR60X30	60"W x 30"H	12/12
GVWTR64X13	64"W x 13-3/8"H	5/12
GVWTR64X16	64"W x 16"H	6/12
GVWTR64X18	64"W x 18-5/8"H	7/12
GVWTR64X21	64"W x 21-1/4"H	8/12
GVWTR64X24	64"W x 24"H	9/12
GVWTR64X26	64"W x 26-5/8"H	10/12
GVWTR64X29	64"W x 29-3/8"H	11/12
GVWTR64X32	64"W x 32"H	12/12
GVWTR68X14	68"W x 14-1/8"H	5/12
GVWTR68X17	68"W x 17"H	6/12
GVWTR68X19	68"W x 19-3/4"H	7/12
GVWTR68X22	68"W x 22-5/8"H	8/12

Part Number	Rough Opening Dimensions	Pitch
GVWTR68X25	68"W x 25-1/2"H	9/12
GVWTR68X28	68"W x 28-3/8"H	10/12
GVWTR68X31	68"W x 31-1/8"H	11/12
GVWTR68X34	68"W x 34"H	12/12
GVWTR72X15	72"W x 15"H	5/12
GVWTR72X18	72"W x 18"H	6/12
GVWTR72X21	72"W x 21"H	7/12
GVWTR72X24	72"W x 24"H	8/12
GVWTR72X27	72"W x 27"H	9/12
GVWTR72X30	72"W x 30"H	10/12
GVWTR72X33	72"W x 33"H	11/12
GVWTR72X36	72"W x 36"H	12/12
GVWTR76X15	76"W x 15-3/4"H	5/12
GVWTR76X19	76"W x 19"H	6/12
GVWTR76X22	76"W x 22-1/8"H	7/12
GVWTR76X25	76"W x 25-3/8"H	8/12
GVWTR76X28	76"W x 28-1/2"H	9/12
GVWTR76X31	76"W x 31-5/8"H	10/12
GVWTR76X34	76"W x 34-3/4"H	11/12
GVWTR76X38	76"W x 38"H	12/12
GVWTR80X16	80"W x 16-5/8"H	5/12
GVWTR80X20	80"W x 20"H	6/12
GVWTR80X23	80"W x 23-3/8"H	7/12
GVWTR80X26	80"W x 26-5/8"H	8/12
GVWTR80X30	80"W x 30"H	9/12
GVWTR80X33	80"W x 33-3/8"H	10/12
GVWTR80X36	80"W x 36-5/8"H	11/12
GVWTR80X40	80"W x 40"H	12/12
GVWTR84X17	84"W x 17-1/2"H	5/12
GVWTR84X21	84"W x 21"H	6/12
GVWTR84X24	84"W x 24-1/2"H	7/12
GVWTR84X28	84"W x 28"H	8/12
GVWTR84X31	84"W x 31-1/2"H	9/12
GVWTR84X35	84"W x 35"H	10/12
GVWTR84X38	84"W x 38-1/2"H	11/12
GVWTR84X42	84"W x 42"H	12/12

WOOD GABLE VENTS

Octagon Top Gable Vents



part number
GVWOT

Part Number	Rough Opening Dimensions
GVWOT12X12	12"W x 12"H
GVWOT12X14	12"W x 14"H
GVWOT12X16	12"W x 16"H
GVWOT12X18	12"W x 18"H
GVWOT12X20	12"W x 20"H
GVWOT12X22	12"W x 22"H
GVWOT12X24	12"W x 24"H
GVWOT12X26	12"W x 26"H
GVWOT12X28	12"W x 28"H
GVWOT12X30	12"W x 30"H
GVWOT12X32	12"W x 32"H
GVWOT12X34	12"W x 34"H
GVWOT12X36	12"W x 36"H
GVWOT16X12	16"W x 12"H
GVWOT16X14	16"W x 14"H
GVWOT16X16	16"W x 16"H
GVWOT16X18	16"W x 18"H
GVWOT16X20	16"W x 20"H
GVWOT16X22	16"W x 22"H
GVWOT16X24	16"W x 24"H

Part Number	Rough Opening Dimensions
GVWOT16X26	16"W x 26"H
GVWOT16X28	16"W x 28"H
GVWOT16X30	16"W x 30"H
GVWOT16X32	16"W x 32"H
GVWOT16X34	16"W x 34"H
GVWOT16X36	16"W x 36"H
GVWOT18X12	18"W x 12"H
GVWOT18X14	18"W x 14"H
GVWOT18X16	18"W x 16"H
GVWOT18X18	18"W x 18"H
GVWOT18X20	18"W x 20"H
GVWOT18X22	18"W x 22"H
GVWOT18X24	18"W x 24"H
GVWOT18X26	18"W x 26"H
GVWOT18X28	18"W x 28"H
GVWOT18X30	18"W x 30"H
GVWOT18X32	18"W x 32"H
GVWOT18X34	18"W x 34"H
GVWOT18X36	18"W x 36"H
GVWOT20X12	20"W x 12"H
GVWOT20X14	20"W x 14"H
GVWOT20X16	20"W x 16"H
GVWOT20X18	20"W x 18"H
GVWOT20X20	20"W x 20"H
GVWOT20X22	20"W x 22"H
GVWOT20X24	20"W x 24"H
GVWOT20X26	20"W x 26"H
GVWOT20X28	20"W x 28"H
GVWOT20X30	20"W x 30"H
GVWOT20X32	20"W x 32"H
GVWOT20X34	20"W x 34"H
GVWOT20X36	20"W x 36"H
GVWOT24X12	24"W x 12"H
GVWOT24X14	24"W x 14"H
GVWOT24X16	24"W x 16"H
GVWOT24X18	24"W x 18"H
GVWOT24X20	24"W x 20"H
GVWOT24X22	24"W x 22"H
GVWOT24X24	24"W x 24"H

Part Number	Rough Opening Dimensions
GVWOT24X26	24"W x 26"H
GVWOT24X28	24"W x 28"H
GVWOT24X30	24"W x 30"H
GVWOT24X32	24"W x 32"H
GVWOT24X34	24"W x 34"H
GVWOT24X36	24"W x 36"H
GVWOT30X12	30"W x 12"H
GVWOT30X14	30"W x 14"H
GVWOT30X16	30"W x 16"H
GVWOT30X18	30"W x 18"H
GVWOT30X20	30"W x 20"H
GVWOT30X22	30"W x 22"H
GVWOT30X24	30"W x 24"H
GVWOT30X26	30"W x 26"H
GVWOT30X28	30"W x 28"H
GVWOT30X30	30"W x 30"H
GVWOT30X32	30"W x 32"H
GVWOT30X34	30"W x 34"H
GVWOT30X36	30"W x 36"H
GVWOT36X12	36"W x 12"H
GVWOT36X14	36"W x 14"H
GVWOT36X16	36"W x 16"H
GVWOT36X18	36"W x 18"H
GVWOT36X20	36"W x 20"H
GVWOT36X22	36"W x 22"H
GVWOT36X24	36"W x 24"H
GVWOT36X26	36"W x 26"H
GVWOT36X28	36"W x 28"H
GVWOT36X30	36"W x 30"H
GVWOT36X32	36"W x 32"H
GVWOT36X34	36"W x 34"H
GVWOT36X36	36"W x 36"H

Arch Top Gable Vents

part number
GVWAR

Diamond Gable Vents



Part Number **Rough Opening Dimensions**

GVWAR12X12	12"W x 12"H
GVWAR12X14	12"W x 14"H
GVWAR12X16	12"W x 16"H
GVWAR12X18	12"W x 18"H
GVWAR12X20	12"W x 20"H
GVWAR12X22	12"W x 22"H
GVWAR12X24	12"W x 24"H
GVWAR12X26	12"W x 26"H
GVWAR12X28	12"W x 28"H
GVWAR12X30	12"W x 30"H
GVWAR12X32	12"W x 32"H
GVWAR12X34	12"W x 34"H
GVWAR12X36	12"W x 36"H
GVWAR14X14	14"W x 14"H
GVWAR14X16	14"W x 16"H
GVWAR14X18	14"W x 18"H
GVWAR14X20	14"W x 20"H
GVWAR14X22	14"W x 22"H
GVWAR14X24	14"W x 24"H
GVWAR14X26	14"W x 26"H
GVWAR14X28	14"W x 28"H
GVWAR14X30	14"W x 30"H
GVWAR14X32	14"W x 32"H
GVWAR14X34	14"W x 34"H
GVWAR14X36	14"W x 36"H
GVWAR16X16	16"W x 16"H
GVWAR16X18	16"W x 18"H
GVWAR16X20	16"W x 20"H
GVWAR16X22	16"W x 22"H
GVWAR16X24	16"W x 24"H

Part Number **Rough Opening Dimensions**

GVWAR16X26	16"W x 26"H
GVWAR16X28	16"W x 28"H
GVWAR16X30	16"W x 30"H
GVWAR16X32	16"W x 32"H
GVWAR16X34	16"W x 34"H
GVWAR16X36	16"W x 36"H
GVWAR18X18	18"W x 18"H
GVWAR18X20	18"W x 20"H
GVWAR18X22	18"W x 22"H
GVWAR18X24	18"W x 24"H
GVWAR18X26	18"W x 26"H
GVWAR18X28	18"W x 28"H
GVWAR18X30	18"W x 30"H
GVWAR18X32	18"W x 32"H
GVWAR18X34	18"W x 34"H
GVWAR18X36	18"W x 36"H
GVWAR20X20	20"W x 20"H
GVWAR20X22	20"W x 22"H
GVWAR20X24	20"W x 24"H
GVWAR20X26	20"W x 26"H
GVWAR20X28	20"W x 28"H
GVWAR20X30	20"W x 30"H
GVWAR20X32	20"W x 32"H
GVWAR20X34	20"W x 34"H
GVWAR20X36	20"W x 36"H
GVWAR22X22	22"W x 22"H
GVWAR22X24	22"W x 24"H
GVWAR22X26	22"W x 26"H
GVWAR22X28	22"W x 28"H
GVWAR22X30	22"W x 30"H
GVWAR22X32	22"W x 32"H
GVWAR22X34	22"W x 34"H
GVWAR22X36	22"W x 36"H
GVWAR24X24	24"W x 24"H
GVWAR24X26	24"W x 26"H
GVWAR24X28	24"W x 28"H
GVWAR24X30	24"W x 30"H
GVWAR24X32	24"W x 32"H
GVWAR24X34	24"W x 34"H
GVWAR24X36	24"W x 36"H



part number
GVWDI

Part Number **Rough Opening Dimensions**

GVWDI12X12	12"W x 12"H
GVWDI14X14	14"W x 14"H
GVWDI16X16	16"W x 16"H
GVWDI18X18	18"W x 18"H
GVWDI20X20	20"W x 20"H
GVWDI22X22	22"W x 22"H
GVWDI24X24	24"W x 24"H

WOOD GABLE VENTS

Round Top Gable Vents



part number
GVWRT

Part Number	Rough Opening Dimensions
GVWRT12X12	12"W x 12"H
GVWRT12X14	12"W x 14"H
GVWRT12X16	12"W x 16"H
GVWRT12X18	12"W x 18"H
GVWRT12X20	12"W x 20"H
GVWRT12X22	12"W x 22"H
GVWRT12X24	12"W x 24"H
GVWRT12X26	12"W x 26"H
GVWRT12X28	12"W x 28"H
GVWRT12X30	12"W x 30"H
GVWRT12X32	12"W x 32"H
GVWRT12X34	12"W x 34"H
GVWRT12X36	12"W x 36"H
GVWRT14X14	14"W x 14"H
GVWRT14X16	14"W x 16"H
GVWRT14X18	14"W x 18"H
GVWRT14X20	14"W x 20"H
GVWRT14X22	14"W x 22"H
GVWRT14X24	14"W x 24"H

Part Number	Rough Opening Dimensions
GVWRT14X26	14"W x 26"H
GVWRT14X28	14"W x 28"H
GVWRT14X30	14"W x 30"H
GVWRT14X32	14"W x 32"H
GVWRT14X34	14"W x 34"H
GVWRT14X36	14"W x 36"H
GVWRT16X16	16"W x 16"H
GVWRT16X18	16"W x 18"H
GVWRT16X20	16"W x 20"H
GVWRT16X22	16"W x 22"H
GVWRT16X24	16"W x 24"H
GVWRT16X26	16"W x 26"H
GVWRT16X28	16"W x 28"H
GVWRT16X30	16"W x 30"H
GVWRT16X32	16"W x 32"H
GVWRT16X34	16"W x 34"H
GVWRT16X36	16"W x 36"H
GVWRT18X18	18"W x 18"H
GVWRT18X20	18"W x 20"H
GVWRT18X22	18"W x 22"H
GVWRT18X24	18"W x 24"H
GVWRT18X26	18"W x 26"H
GVWRT18X28	18"W x 28"H
GVWRT18X30	18"W x 30"H
GVWRT18X32	18"W x 32"H
GVWRT18X34	18"W x 34"H
GVWRT18X36	18"W x 36"H
GVWRT20X20	20"W x 20"H
GVWRT20X22	20"W x 22"H
GVWRT20X24	20"W x 24"H
GVWRT20X26	20"W x 26"H
GVWRT20X28	20"W x 28"H
GVWRT20X30	20"W x 30"H
GVWRT20X32	20"W x 32"H
GVWRT20X34	20"W x 34"H
GVWRT20X36	20"W x 36"H
GVWRT22X22	22"W x 22"H
GVWRT22X24	22"W x 24"H

Part Number	Rough Opening Dimensions
GVWRT22X26	22"W x 26"H
GVWRT22X28	22"W x 28"H
GVWRT22X30	22"W x 30"H
GVWRT22X32	22"W x 32"H
GVWRT22X34	22"W x 34"H
GVWRT22X36	22"W x 36"H
GVWRT24X24	24"W x 24"H
GVWRT24X26	24"W x 26"H
GVWRT24X28	24"W x 28"H
GVWRT24X30	24"W x 30"H
GVWRT24X32	24"W x 32"H
GVWRT24X34	24"W x 34"H
GVWRT24X36	24"W x 36"H
GVWRT26X24	26"W x 24"H
GVWRT26X26	26"W x 26"H
GVWRT26X28	26"W x 28"H
GVWRT26X30	26"W x 30"H
GVWRT26X32	26"W x 32"H
GVWRT26X34	26"W x 34"H
GVWRT26X36	26"W x 36"H
GVWRT28X24	28"W x 24"H
GVWRT28X26	28"W x 26"H
GVWRT28X28	28"W x 28"H
GVWRT28X30	28"W x 30"H
GVWRT28X32	28"W x 32"H
GVWRT28X34	28"W x 34"H
GVWRT28X36	28"W x 36"H
GVWRT30X24	30"W x 24"H
GVWRT30X26	30"W x 26"H
GVWRT30X28	30"W x 28"H
GVWRT30X30	30"W x 30"H
GVWRT30X32	30"W x 32"H
GVWRT30X34	30"W x 34"H
GVWRT30X36	30"W x 36"H
GVWRT32X24	32"W x 24"H
GVWRT32X26	32"W x 26"H
GVWRT32X28	32"W x 28"H
GVWRT32X30	32"W x 30"H

Half Round Gable Vents



part number
GVWHR

Part Number	Rough Opening Dimensions
GVWRT32X32	32"W x 32"H
GVWRT32X34	32"W x 34"H
GVWRT32X36	32"W x 36"H
GVWRT34X24	34"W x 24"H
GVWRT34X26	34"W x 26"H
GVWRT34X28	34"W x 28"H
GVWRT34X30	34"W x 30"H
GVWRT34X32	34"W x 32"H
GVWRT34X34	34"W x 34"H
GVWRT34X36	34"W x 36"H
GVWRT36X24	36"W x 24"H
GVWRT36X26	36"W x 26"H
GVWRT36X28	36"W x 28"H
GVWRT36X30	36"W x 30"H
GVWRT36X32	36"W x 32"H
GVWRT36X34	36"W x 34"H
GVWRT36X36	36"W x 36"H

Part Number	Rough Opening Dimensions
GVWHR12	12"W x 6"H
GVWHR14	14"W x 7"H
GVWHR16	16"W x 8"H
GVWHR18	18"W x 9"H
GVWHR20	20"W x 10"H
GVWHR22	22"W x 11"H
GVWHR24	24"W x 12"H
GVWHR26	26"W x 13"H
GVWHR28	28"W x 14"H
GVWHR30	30"W x 15"H
GVWHR32	32"W x 16"H
GVWHR34	34"W x 17"H
GVWHR36	36"W x 18"H



WOOD GABLE VENTS

Horizontal Round Gable Vents



part number

GVWRE

Part Number	Rough Opening Dimensions	Part Number	Rough Opening Dimensions
GVWRE14X12	14"W X 12"H	GVWRE26X18	26"W X 18"H
GVWRE16X12	16"W X 12"H	GVWRE26X20	26"W X 20"H
GVWRE16X14	16"W X 14"H	GVWRE26X22	26"W X 22"H
GVWRE18X12	18"W X 12"H	GVWRE26X24	26"W X 24"H
GVWRE18X14	18"W X 14"H	GVWRE28X12	28"W X 12"H
GVWRE18X16	18"W X 16"H	GVWRE28X14	28"W X 14"H
GVWRE20X12	20"W X 12"H	GVWRE28X16	28"W X 16"H
GVWRE20X14	20"W X 14"H	GVWRE28X18	28"W X 18"H
GVWRE20X16	20"W X 16"H	GVWRE28X20	28"W X 20"H
GVWRE20X18	20"W X 18"H	GVWRE28X22	28"W X 22"H
GVWRE22X12	22"W X 12"H	GVWRE28X24	28"W X 24"H
GVWRE22X14	22"W X 14"H	GVWRE28X26	28"W X 26"H
GVWRE22X16	22"W X 16"H	GVWRE30X12	30"W X 12"H
GVWRE22X18	22"W X 18"H	GVWRE30X14	30"W X 14"H
GVWRE22X20	22"W X 20"H	GVWRE30X16	30"W X 16"H
GVWRE24X12	24"W X 12"H	GVWRE30X18	30"W X 18"H
GVWRE24X14	24"W X 14"H	GVWRE30X20	30"W X 20"H
GVWRE24X16	24"W X 16"H	GVWRE30X22	30"W X 22"H
GVWRE24X18	24"W X 18"H	GVWRE30X24	30"W X 24"H
GVWRE24X20	24"W X 20"H	GVWRE30X26	30"W X 26"H
GVWRE24X22	24"W X 22"H	GVWRE30X28	30"W X 28"H
GVWRE26X12	26"W X 12"H	GVWRE36X12	36"W X 12"H
GVWRE26X14	26"W X 14"H	GVWRE36X14	36"W X 14"H
GVWRE26X16	26"W X 16"H	GVWRE36X16	36"W X 16"H
		GVWRE36X18	36"W X 18"H
		GVWRE36X20	36"W X 20"H
		GVWRE36X22	36"W X 22"H
		GVWRE36X24	36"W X 24"H
		GVWRE36X26	36"W X 26"H
		GVWRE36X28	36"W X 28"H
		GVWRE36X30	36"W X 30"H
		GVWRE36X32	36"W X 32"H
		GVWRE36X34	36"W X 34"H



Vertical Round Gable Vents



part number
GVWVR

Part Number **Rough Opening Dimensions**

GVWVR16X28	16"W x 28"H
GVWVR16X30	16"W x 30"H
GVWVR16X32	16"W x 32"H
GVWVR16X34	16"W x 34"H
GVWVR16X36	16"W x 36"H
GVWVR18X20	18"W x 20"H
GVWVR18X22	18"W x 22"H
GVWVR18X24	18"W x 24"H
GVWVR18X26	18"W x 26"H
GVWVR18X28	18"W x 28"H
GVWVR18X30	18"W x 30"H
GVWVR18X32	18"W x 32"H
GVWVR18X34	18"W x 34"H
GVWVR18X36	18"W x 36"H
GVWVR20X22	20"W x 22"H
GVWVR20X24	20"W x 24"H
GVWVR20X26	20"W x 26"H
GVWVR20X28	20"W x 28"H
GVWVR20X30	20"W x 30"H
GVWVR20X32	20"W x 32"H
GVWVR20X34	20"W x 34"H
GVWVR20X36	20"W x 36"H
GVWVR22X24	22"W x 24"H
GVWVR22X26	22"W x 26"H
GVWVR22X28	22"W x 28"H
GVWVR22X30	22"W x 30"H
GVWVR22X32	22"W x 32"H
GVWVR22X34	22"W x 34"H
GVWVR22X36	22"W x 36"H
GVWVR24X26	24"W x 26"H
GVWVR24X28	24"W x 28"H
GVWVR24X30	24"W x 30"H
GVWVR24X32	24"W x 32"H

Part Number **Rough Opening Dimensions**

GVWVR12X14	12"W x 14"H
GVWVR12X16	12"W x 16"H
GVWVR12X18	12"W x 18"H
GVWVR12X20	12"W x 20"H
GVWVR12X22	12"W x 22"H
GVWVR12X24	12"W x 24"H
GVWVR12X26	12"W x 26"H
GVWVR12X28	12"W x 28"H
GVWVR12X30	12"W x 30"H
GVWVR12X32	12"W x 32"H
GVWVR12X34	12"W x 34"H
GVWVR12X36	12"W x 36"H
GVWVR14X16	14"W x 16"H
GVWVR14X18	14"W x 18"H
GVWVR14X20	14"W x 20"H
GVWVR14X22	14"W x 22"H
GVWVR14X24	14"W x 24"H
GVWVR14X26	14"W x 26"H
GVWVR14X28	14"W x 28"H
GVWVR14X30	14"W x 30"H
GVWVR14X32	14"W x 32"H
GVWVR14X34	14"W x 34"H
GVWVR14X36	14"W x 36"H
GVWVR16X18	16"W x 18"H
GVWVR16X20	16"W x 20"H
GVWVR16X22	16"W x 22"H
GVWVR16X24	16"W x 24"H
GVWVR16X26	16"W x 26"H

Round Gable Vents



part number
GVWRO

Part Number **Rough Opening Dimensions**

GVWRO12	12"
GVWRO14	14"
GVWRO16	16"
GVWRO18	18"
GVWRO20	20"
GVWRO22	22"
GVWRO24	24"
GVWRO26	26"
GVWRO28	28"
GVWRO30	30"
GVWRO32	32"
GVWRO34	34"
GVWRO36	36"

WOOD GABLE VENTS

Vertical Elongated Octagon Gable Vents



part number

GVWOV

Part Number	Rough Opening Dimensions
GVWOV12X14	12"W x 14"H
GVWOV12X16	12"W x 16"H
GVWOV12X18	12"W x 18"H
GVWOV12X20	12"W x 20"H
GVWOV12X22	12"W x 22"H
GVWOV12X24	12"W x 24"H
GVWOV12X26	12"W x 26"H
GVWOV12X28	12"W x 28"H
GVWOV12X30	12"W x 30"H
GVWOV12X32	12"W x 32"H
GVWOV12X34	12"W x 34"H
GVWOV12X36	12"W x 36"H
GVWOV14X16	14"W x 16"H
GVWOV14X18	14"W x 18"H
GVWOV14X20	14"W x 20"H
GVWOV14X22	14"W x 22"H
GVWOV14X24	14"W x 24"H
GVWOV14X26	14"W x 26"H
GVWOV14X28	14"W x 28"H
GVWOV14X30	14"W x 30"H
GVWOV14X32	14"W x 32"H
GVWOV14X34	14"W x 34"H
GVWOV14X36	14"W x 36"H
GVWOV16X18	16"W x 18"H
GVWOV16X20	16"W x 20"H
GVWOV16X22	16"W x 22"H
GVWOV16X24	16"W x 24"H

Part Number	Rough Opening Dimensions
GVWOV16X26	16"W x 26"H
GVWOV16X28	16"W x 28"H
GVWOV16X30	16"W x 30"H
GVWOV16X32	16"W x 32"H
GVWOV16X34	16"W x 34"H
GVWOV16X36	16"W x 36"H
GVWOV18X20	18"W x 20"H
GVWOV18X22	18"W x 22"H
GVWOV18X24	18"W x 24"H
GVWOV18X26	18"W x 26"H
GVWOV18X28	18"W x 28"H
GVWOV18X30	18"W x 30"H
GVWOV18X32	18"W x 32"H
GVWOV18X34	18"W x 34"H
GVWOV18X36	18"W x 36"H
GVWOV20X22	20"W x 22"H
GVWOV20X24	20"W x 24"H
GVWOV20X26	20"W x 26"H
GVWOV20X28	20"W x 28"H
GVWOV20X30	20"W x 30"H
GVWOV20X32	20"W x 32"H
GVWOV20X34	20"W x 34"H
GVWOV20X36	20"W x 36"H
GVWOV22X24	22"W x 24"H
GVWOV22X26	22"W x 26"H
GVWOV22X28	22"W x 28"H
GVWOV22X30	22"W x 30"H
GVWOV22X32	22"W x 32"H
GVWOV22X34	22"W x 34"H
GVWOV22X36	22"W x 36"H
GVWOV24X26	24"W x 26"H
GVWOV24X28	24"W x 28"H
GVWOV24X30	24"W x 30"H
GVWOV24X32	24"W x 32"H
GVWOV24X34	24"W x 34"H
GVWOV24X36	24"W x 36"H
GVWOV30X32	30"W x 32"H
GVWOV30X34	30"W x 34"H
GVWOV30X36	30"W x 36"H



Horizontal Elongated Octagon Gable Vents



part number
GVWOH

Part Number	Rough Opening Dimensions
GVWOH14X12	14"W X 12"H
GVWOH16X12	16"W X 12"H
GVWOH16X14	16"W X 14"H
GVWOH18X12	18"W X 12"H
GVWOH18X14	18"W X 14"H
GVWOH18X16	18"W X 16"H
GVWOH20X12	20"W X 12"H
GVWOH20X14	20"W X 14"H
GVWOH20X16	20"W X 16"H
GVWOH20X18	20"W X 18"H
GVWOH22X12	22"W X 12"H
GVWOH22X14	22"W X 14"H
GVWOH22X16	22"W X 16"H
GVWOH22X18	22"W X 18"H
GVWOH22X20	22"W X 20"H
GVWOH24X12	24"W X 12"H
GVWOH24X14	24"W X 14"H
GVWOH24X16	24"W X 16"H
GVWOH24X18	24"W X 18"H
GVWOH24X20	24"W X 20"H
GVWOH24X22	24"W X 22"H
GVWOH26X12	26"W X 12"H
GVWOH26X14	26"W X 14"H
GVWOH26X16	26"W X 16"H

Part Number Rough Opening Dimensions

GVOH26X18	26"W X 18"H
GVOH26X20	26"W X 20"H
GVOH26X22	26"W X 22"H
GVOH26X24	26"W X 24"H
GVOH28X12	28"W X 12"H
GVOH28X14	28"W X 14"H
GVOH28X16	28"W X 16"H
GVOH28X18	28"W X 18"H
GVOH28X20	28"W X 20"H
GVOH28X22	28"W X 22"H
GVOH28X24	28"W X 24"H
GVOH28X26	28"W X 26"H
GVOH30X12	30"W X 12"H
GVOH30X14	30"W X 14"H
GVOH30X16	30"W X 16"H
GVOH30X18	30"W X 18"H
GVOH30X20	30"W X 20"H
GVOH30X22	30"W X 22"H
GVOH30X24	30"W X 24"H
GVOH30X26	30"W X 26"H
GVOH30X28	30"W X 28"H
GVOH36X12	36"W X 12"H
GVOH36X14	36"W X 14"H
GVOH36X16	36"W X 16"H
GVOH36X18	36"W X 18"H
GVOH36X20	36"W X 20"H
GVOH36X22	36"W X 22"H
GVOH36X24	36"W X 24"H
GVOH36X26	36"W X 26"H
GVOH36X28	36"W X 28"H
GVOH36X30	36"W X 30"H
GVOH36X32	36"W X 32"H
GVOH36X34	36"W X 34"H

Octagonal Gable Vents



part number
GWVOC

Part Number Rough Opening Dimensions

GWVOC12	12"
GWVOC14	14"
GWVOC16	16"
GWVOC18	18"
GWVOC20	20"
GWVOC22	22"
GWVOC24	24"
GWVOC26	26"
GWVOC28	28"
GWVOC30	30"
GWVOC32	32"
GWVOC34	34"
GWVOC36	36"

WOOD GABLE VENTS

Horizontal Peaked Gable Vents



part number
GVWHP

Part Number	Rough Opening Dimensions
GVWHP12X12	12"W x 12"H
GVWHP12X14	12"W x 14"H
GVWHP12X16	12"W x 16"H
GVWHP12X18	12"W x 18"H
GVWHP12X20	12"W x 20"H
GVWHP12X22	12"W x 22"H
GVWHP12X24	12"W x 24"H
GVWHP12X26	12"W x 26"H
GVWHP12X28	12"W x 28"H
GVWHP12X30	12"W x 30"H
GVWHP12X32	12"W x 32"H
GVWHP12X34	12"W x 34"H
GVWHP12X36	12"W x 36"H
GVWHP16X12	16"W x 12"H
GVWHP16X14	16"W x 14"H
GVWHP16X16	16"W x 16"H
GVWHP16X18	16"W x 18"H
GVWHP16X20	16"W x 20"H
GVWHP16X22	16"W x 22"H
GVWHP16X24	16"W x 24"H
GVWHP16X26	16"W x 26"H
GVWHP16X28	16"W x 28"H
GVWHP16X30	16"W x 30"H

Part Number	Rough Opening Dimensions
GVWHP16X32	16"W x 32"H
GVWHP16X34	16"W x 34"H
GVWHP16X36	16"W x 36"H
GVWHP18X12	18"W x 12"H
GVWHP18X14	18"W x 14"H
GVWHP18X16	18"W x 16"H
GVWHP18X18	18"W x 18"H
GVWHP18X20	18"W x 20"H
GVWHP18X22	18"W x 22"H
GVWHP18X24	18"W x 24"H
GVWHP18X26	18"W x 26"H
GVWHP18X28	18"W x 28"H
GVWHP18X30	18"W x 30"H
GVWHP18X32	18"W x 32"H
GVWHP18X34	18"W x 34"H
GVWHP18X36	18"W x 36"H
GVWHP20X12	20"W x 12"H
GVWHP20X14	20"W x 14"H
GVWHP20X16	20"W x 16"H
GVWHP20X18	20"W x 18"H
GVWHP20X20	20"W x 20"H
GVWHP20X22	20"W x 22"H
GVWHP20X24	20"W x 24"H
GVWHP20X26	20"W x 26"H
GVWHP20X28	20"W x 28"H
GVWHP20X30	20"W x 30"H
GVWHP20X32	20"W x 32"H
GVWHP20X34	20"W x 34"H
GVWHP20X36	20"W x 36"H
GVWHP24X12	24"W x 12"H
GVWHP24X14	24"W x 14"H
GVWHP24X16	24"W x 16"H
GVWHP24X18	24"W x 18"H
GVWHP24X20	24"W x 20"H
GVWHP24X22	24"W x 22"H
GVWHP24X24	24"W x 24"H
GVWHP24X26	24"W x 26"H
GVWHP24X28	24"W x 28"H
GVWHP24X30	24"W x 30"H

Part Number	Rough Opening Dimensions
GVWHP24X32	24"W x 32"H
GVWHP24X34	24"W x 34"H
GVWHP24X36	24"W x 36"H
GVWHP30X12	30"W x 12"H
GVWHP30X14	30"W x 14"H
GVWHP30X16	30"W x 16"H
GVWHP30X18	30"W x 18"H
GVWHP30X20	30"W x 20"H
GVWHP30X22	30"W x 22"H
GVWHP30X24	30"W x 24"H
GVWHP30X26	30"W x 26"H
GVWHP30X28	30"W x 28"H
GVWHP30X30	30"W x 30"H
GVWHP30X32	30"W x 32"H
GVWHP30X34	30"W x 34"H
GVWHP30X36	30"W x 36"H
GVWHP36X12	36"W x 12"H
GVWHP36X14	36"W x 14"H
GVWHP36X16	36"W x 16"H
GVWHP36X18	36"W x 18"H
GVWHP36X20	36"W x 20"H
GVWHP36X22	36"W x 22"H
GVWHP36X24	36"W x 24"H
GVWHP36X26	36"W x 26"H
GVWHP36X28	36"W x 28"H
GVWHP36X30	36"W x 30"H
GVWHP36X32	36"W x 32"H
GVWHP36X34	36"W x 34"H
GVWHP36X36	36"W x 36"H

Vertical Peaked Gable Vents



Make sure to choose a pitch for this style! We make them all!

part number
GVWVP

Part Number	Rough Opening Dimensions
GVWVP12X12	12"W x 12"H
GVWVP12X14	12"W x 14"H
GVWVP12X16	12"W x 16"H
GVWVP12X18	12"W x 18"H
GVWVP12X20	12"W x 20"H
GVWVP12X22	12"W x 22"H
GVWVP12X24	12"W x 24"H
GVWVP12X26	12"W x 26"H
GVWVP12X28	12"W x 28"H
GVWVP12X30	12"W x 30"H
GVWVP12X32	12"W x 32"H
GVWVP12X34	12"W x 34"H
GVWVP12X36	12"W x 36"H
GVWVP16X12	16"W x 12"H
GVWVP16X14	16"W x 14"H
GVWVP16X16	16"W x 16"H
GVWVP16X18	16"W x 18"H
GVWVP16X20	16"W x 20"H
GVWVP16X22	16"W x 22"H
GVWVP16X24	16"W x 24"H
GVWVP16X26	16"W x 26"H
GVWVP16X28	16"W x 28"H
GVWVP16X30	16"W x 30"H

Part Number	Rough Opening Dimensions
GVWVP16X32	16"W x 32"H
GVWVP16X34	16"W x 34"H
GVWVP16X36	16"W x 36"H
GVWVP18X12	18"W x 12"H
GVWVP18X14	18"W x 14"H
GVWVP18X16	18"W x 16"H
GVWVP18X18	18"W x 18"H
GVWVP18X20	18"W x 20"H
GVWVP18X22	18"W x 22"H
GVWVP18X24	18"W x 24"H
GVWVP18X26	18"W x 26"H
GVWVP18X28	18"W x 28"H
GVWVP18X30	18"W x 30"H
GVWVP18X32	18"W x 32"H
GVWVP18X34	18"W x 34"H
GVWVP18X36	18"W x 36"H
GVWVP20X12	20"W x 12"H
GVWVP20X14	20"W x 14"H
GVWVP20X16	20"W x 16"H
GVWVP20X18	20"W x 18"H
GVWVP20X20	20"W x 20"H
GVWVP20X22	20"W x 22"H
GVWVP20X24	20"W x 24"H
GVWVP20X26	20"W x 26"H
GVWVP20X28	20"W x 28"H
GVWVP20X30	20"W x 30"H
GVWVP20X32	20"W x 32"H
GVWVP20X34	20"W x 34"H
GVWVP20X36	20"W x 36"H
GVWVP24X12	24"W x 12"H
GVWVP24X14	24"W x 14"H
GVWVP24X16	24"W x 16"H
GVWVP24X18	24"W x 18"H
GVWVP24X20	24"W x 20"H
GVWVP24X22	24"W x 22"H
GVWVP24X24	24"W x 24"H
GVWVP24X26	24"W x 26"H
GVWVP24X28	24"W x 28"H
GVWVP24X30	24"W x 30"H

Part Number	Rough Opening Dimensions
GVWVP24X32	24"W x 32"H
GVWVP24X34	24"W x 34"H
GVWVP24X36	24"W x 36"H
GVWVP30X12	30"W x 12"H
GVWVP30X14	30"W x 14"H
GVWVP30X16	30"W x 16"H
GVWVP30X18	30"W x 18"H
GVWVP30X20	30"W x 20"H
GVWVP30X22	30"W x 22"H
GVWVP30X24	30"W x 24"H
GVWVP30X26	30"W x 26"H
GVWVP30X28	30"W x 28"H
GVWVP30X30	30"W x 30"H
GVWVP30X32	30"W x 32"H
GVWVP30X34	30"W x 34"H
GVWVP30X36	30"W x 36"H
GVWVP36X12	36"W x 12"H
GVWVP36X14	36"W x 14"H
GVWVP36X16	36"W x 16"H
GVWVP36X18	36"W x 18"H
GVWVP36X20	36"W x 20"H
GVWVP36X22	36"W x 22"H
GVWVP36X24	36"W x 24"H
GVWVP36X26	36"W x 26"H
GVWVP36X28	36"W x 28"H
GVWVP36X30	36"W x 30"H
GVWVP36X32	36"W x 32"H
GVWVP36X34	36"W x 34"H
GVWVP36X36	36"W x 36"H

WOOD GABLE VENTS

Quarter Round Top Left Gable Vents



part number

GVWQL

Part Number	Rough Opening Dimensions	Part Number	Rough Opening Dimensions
GVWQL06X12	6"W X 12"H	GVWQL08X12	8"W X 12"H
GVWQL06X14	6"W X 14"H	GVWQL08X14	8"W X 14"H
GVWQL06X16	6"W X 16"H	GVWQL08X16	8"W X 16"H
GVWQL06X18	6"W X 18"H	GVWQL08X18	8"W X 18"H
GVWQL06X20	6"W X 20"H	GVWQL08X20	8"W X 20"H
GVWQL06X22	6"W X 22"H	GVWQL08X22	8"W X 22"H
GVWQL06X24	6"W X 24"H	GVWQL08X24	8"W X 24"H
GVWQL06X26	6"W X 26"H	GVWQL08X26	8"W X 26"H
GVWQL06X28	6"W X 28"H	GVWQL08X28	8"W X 28"H
GVWQL06X30	6"W X 30"H	GVWQL08X30	8"W X 30"H
GVWQL06X32	6"W X 32"H	GVWQL09X12	9"W X 12"H
GVWQL06X34	6"W X 34"H	GVWQL09X14	9"W X 14"H
GVWQL06X36	6"W X 36"H	GVWQL09X16	9"W X 16"H
GVWQL08X12	8"W X 12"H	GVWQL09X18	9"W X 18"H
GVWQL08X14	8"W X 14"H	GVWQL09X20	9"W X 20"H
GVWQL08X16	8"W X 16"H	GVWQL09X22	9"W X 22"H
GVWQL08X18	8"W X 18"H	GVWQL09X24	9"W X 24"H
GVWQL08X20	8"W X 20"H	GVWQL09X26	9"W X 26"H
GVWQL08X22	8"W X 22"H	GVWQL09X28	9"W X 28"H
GVWQL08X24	8"W X 24"H	GVWQL09X30	9"W X 30"H
GVWQL08X26	8"W X 26"H	GVWQL09X32	9"W X 32"H
GVWQL08X28	8"W X 28"H	GVWQL09X34	9"W X 34"H
GVWQL08X30	8"W X 30"H	GVWQL09X36	9"W X 36"H
		GVWQL10X12	10"W X 12"H
		GVWQL10X14	10"W X 14"H
		GVWQL10X16	10"W X 16"H
		GVWQL10X18	10"W X 18"H
		GVWQL10X20	10"W X 20"H
		GVWQL10X22	10"W X 22 "H
		GVWQL10X24	10"W X 24"H
		GVWQL10X26	10"W X 26"H
		GVWQL10X28	10"W X 28"H
		GVWQL10X30	10"W X 30"H
		GVWQL10X32	10"W X 32"H
		GVWQL10X34	10"W X 34"H
		GVWQL10X36	10"W X 36"H
		GVWQL12X12	12"W x 12"H
		GVWQL12X14	12"W x 14"H
		GVWQL12X16	12"W x 16"H
		GVWQL12X18	12"W x 18"H
		GVWQL12X20	12"W x 20"H
		GVWQL12X22	12"W x 22"H
		GVWQL12X24	12"W x 24"H
		GVWQL12X26	12"W x 26"H
		GVWQL12X28	12"W x 28"H
		GVWQL12X30	12"W x 30"H
		GVWQL12X32	12"W x 32"H
		GVWQL12X34	12"W x 34"H
		GVWQL12X36	12"W x 36"H
		GVWQL15X12	15"W X 12"H
		GVWQL15X14	15"W X 14"H
		GVWQL15X16	15"W X 16"H
		GVWQL15X18	15"W X 18"H
		GVWQL15X20	15"W X 20"H
		GVWQL15X22	15"W X 22"H
		GVWQL15X24	15"W X 24"H
		GVWQL15X26	15"W X 26"H
		GVWQL15X28	15"W X 28"H
		GVWQL15X30	15"W X 30"H
		GVWQL15X32	15"W X 32"H
		GVWQL15X34	15"W X 34"H
		GVWQL15X36	15"W X 36"H
		GVWQL18X12	18"W x 12"H
		GVWQL18X14	18"W x 14"H
		GVWQL18X16	18"W x 16"H
		GVWQL18X18	18"W x 18"H
		GVWQL18X20	18"W x 20"H
		GVWQL18X22	18"W x 22"H
		GVWQL18X24	18"W x 24"H
		GVWQL18X26	18"W x 26"H
		GVWQL18X28	18"W x 28"H
		GVWQL18X30	18"W x 30"H
		GVWQL18X32	18"W x 32"H
		GVWQL18X34	18"W x 34"H
		GVWQL18X36	18"W x 36"H

Quarter Round Top Right Gable Vents



part number

GVWQR

Part Number	Rough Opening Dimensions
GVWQR06X12	6"W X 12"H
GVWQR06X14	6"W X 14"H
GVWQR06X16	6"W X 16"H
GVWQR06X18	6"W X 18"H
GVWQR06X20	6"W X 20"H
GVWQR06X22	6"W X 22"H
GVWQR06X24	6"W X 24"H
GVWQR06X26	6"W X 26"H
GVWQR06X28	6"W X 28"H
GVWQR06X30	6"W X 30"H
GVWQR06X32	6"W X 32"H
GVWQR06X34	6"W X 34"H
GVWQR06X36	6"W X 36"H
GVWQR08X12	8"W X 12"H
GVWQR08X14	8"W X 14"H
GVWQR08X16	8"W X 16"H
GVWQR08X18	8"W X 18"H
GVWQR08X20	8"W X 20"H
GVWQR08X22	8"W X 22"H
GVWQR08X24	8"W X 24"H
GVWQR08X26	8"W X 26"H
GVWQR08X28	8"W X 28"H
GVWQR08X30	8"W X 30"H

Part Number	Rough Opening Dimensions
GVWQR08X32	8"W X 32"H
GVWQR08X34	8"W X 34"H
GVWQR08X36	8"W X 36"H
GVWQR09X12	9"W X 12"H
GVWQR09X14	9"W X 14"H
GVWQR09X16	9"W X 16"H
GVWQR09X18	9"W X 18"H
GVWQR09X20	9"W X 20"H
GVWQR09X22	9"W X 22"H
GVWQR09X24	9"W X 24"H
GVWQR09X26	9"W X 26"H
GVWQR09X28	9"W X 28"H
GVWQR09X30	9"W X 30"H
GVWQR09X32	9"W X 32"H
GVWQR09X34	9"W X 34"H
GVWQR09X36	9"W X 36"H
GVWQR10X12	10"W X 12"H
GVWQR10X14	10"W X 14"H
GVWQR10X16	10"W X 16"H
GVWQR10X18	10"W X 18"H
GVWQR10X20	10"W X 20"H
GVWQR10X22	10"W X 22"H
GVWQR10X24	10"W X 24"H
GVWQR10X26	10"W X 26"H
GVWQR10X28	10"W X 28"H
GVWQR10X30	10"W X 30"H
GVWQR10X32	10"W X 32"H
GVWQR10X34	10"W X 34"H
GVWQR10X36	10"W X 36"H
GVWQR12X12	12"W x 12"H
GVWQR12X14	12"W x 14"H
GVWQR12X16	12"W x 16"H
GVWQR12X18	12"W x 18"H
GVWQR12X20	12"W x 20"H
GVWQR12X22	12"W x 22"H
GVWQR12X24	12"W x 24"H
GVWQR12X26	12"W x 26"H
GVWQR12X28	12"W x 28"H
GVWQR12X30	12"W x 30"H

Part Number	Rough Opening Dimensions
GVWQR12X32	12"W x 32"H
GVWQR12X34	12"W x 34"H
GVWQR12X36	12"W x 36"H
GVWQR15X12	15"W X 12"H
GVWQR15X14	15"W X 14"H
GVWQR15X16	15"W X 16"H
GVWQR15X18	15"W X 18"H
GVWQR15X20	15"W X 20"H
GVWQR15X22	15"W X 22"H
GVWQR15X24	15"W X 24"H
GVWQR15X26	15"W X 26"H
GVWQR15X28	15"W X 28"H
GVWQR15X30	15"W X 30"H
GVWQR15X32	15"W X 32"H
GVWQR15X34	15"W X 34"H
GVWQR15X36	15"W X 36"H
GVWQR18X12	18"W x 12"H
GVWQR18X14	18"W x 14"H
GVWQR18X16	18"W x 16"H
GVWQR18X18	18"W x 18"H
GVWQR18X20	18"W x 20"H
GVWQR18X22	18"W x 22"H
GVWQR18X24	18"W x 24"H
GVWQR18X26	18"W x 26"H
GVWQR18X28	18"W x 28"H
GVWQR18X30	18"W x 30"H
GVWQR18X32	18"W x 32"H
GVWQR18X34	18"W x 34"H
GVWQR18X36	18"W x 36"H

WOOD GABLE VENTS

Half Octagon Top Left Gable Vents



part number

GVWOL

Part Number	Rough Opening Dimensions	Part Number	Rough Opening Dimensions
GVWOL12X12	12"W x 12"H	GVWOL16X12	16"W x 12"H
GVWOL12X14	12"W x 14"H	GVWOL16X14	16"W x 14"H
GVWOL12X16	12"W x 16"H	GVWOL16X16	16"W x 16"H
GVWOL12X18	12"W x 18"H	GVWOL16X18	16"W x 18"H
GVWOL12X20	12"W x 20"H	GVWOL16X20	16"W x 20"H
GVWOL12X22	12"W x 22"H	GVWOL16X22	16"W x 22"H
GVWOL12X24	12"W x 24"H	GVWOL16X24	16"W x 24"H
GVWOL12X26	12"W x 26"H	GVWOL16X26	16"W x 26"H
GVWOL12X28	12"W x 28"H	GVWOL16X28	16"W x 28"H
GVWOL12X30	12"W x 30"H	GVWOL16X30	16"W x 30"H
GVWOL12X32	12"W x 32"H	GVWOL18X12	18"W x 12"H
GVWOL12X34	12"W x 34"H	GVWOL18X14	18"W x 14"H
GVWOL12X36	12"W x 36"H	GVWOL18X16	18"W x 16"H
GVWOL16X12	16"W x 12"H	GVWOL18X18	18"W x 18"H
GVWOL16X14	16"W x 14"H	GVWOL18X20	18"W x 20"H
GVWOL16X16	16"W x 16"H	GVWOL18X22	18"W x 22"H
GVWOL16X18	16"W x 18"H	GVWOL18X24	18"W x 24"H
GVWOL16X20	16"W x 20"H	GVWOL18X26	18"W x 26"H
GVWOL16X22	16"W x 22"H	GVWOL18X28	18"W x 28"H
GVWOL16X24	16"W x 24"H	GVWOL18X30	18"W x 30"H
GVWOL16X26	16"W x 26"H	GVWOL18X32	18"W x 32"H
GVWOL16X28	16"W x 28"H	GVWOL18X34	18"W x 34"H
GVWOL16X30	16"W x 30"H	GVWOL18X36	18"W x 36"H
		GVWOL20X12	20"W x 12"H
		GVWOL20X14	20"W x 14"H
		GVWOL20X16	20"W x 16"H
		GVWOL20X18	20"W x 18"H
		GVWOL20X20	20"W x 20"H
		GVWOL20X22	20"W x 22"H
		GVWOL20X24	20"W x 24"H
		GVWOL20X26	20"W x 26"H
		GVWOL20X28	20"W x 28"H
		GVWOL20X30	20"W x 30"H
		GVWOL20X32	20"W x 32"H
		GVWOL20X34	20"W x 34"H
		GVWOL20X36	20"W x 36"H
		GVWOL24X12	24"W x 12"H
		GVWOL24X14	24"W x 14"H
		GVWOL24X16	24"W x 16"H
		GVWOL24X18	24"W x 18"H
		GVWOL24X20	24"W x 20"H
		GVWOL24X22	24"W x 22"H
		GVWOL24X24	24"W x 24"H
		GVWOL24X26	24"W x 26"H
		GVWOL24X28	24"W x 28"H
		GVWOL24X30	24"W x 30"H
		GVWOL24X32	24"W x 32"H
		GVWOL24X34	24"W x 34"H
		GVWOL24X36	24"W x 36"H
		GVWOL30X12	30"W x 12"H
		GVWOL30X14	30"W x 14"H
		GVWOL30X16	30"W x 16"H
		GVWOL30X18	30"W x 18"H
		GVWOL30X20	30"W x 20"H
		GVWOL30X22	30"W x 22"H
		GVWOL30X24	30"W x 24"H
		GVWOL30X26	30"W x 26"H
		GVWOL30X28	30"W x 28"H
		GVWOL30X30	30"W x 30"H
		GVWOL30X32	30"W x 32"H
		GVWOL30X34	30"W x 34"H
		GVWOL30X36	30"W x 36"H
		GVWOL36X12	36"W x 12"H
		GVWOL36X14	36"W x 14"H
		GVWOL36X16	36"W x 16"H
		GVWOL36X18	36"W x 18"H
		GVWOL36X20	36"W x 20"H
		GVWOL36X22	36"W x 22"H
		GVWOL36X24	36"W x 24"H
		GVWOL36X26	36"W x 26"H
		GVWOL36X28	36"W x 28"H
		GVWOL36X30	36"W x 30"H
		GVWOL36X32	36"W x 32"H
		GVWOL36X34	36"W x 34"H
		GVWOL36X36	36"W x 36"H

Half Octagon Top Right Gable Vents



part number

GVWOR

Part Number	Rough Opening Dimensions
GVWOR12X12	12"W x 12"H
GVWOR12X14	12"W x 14"H
GVWOR12X16	12"W x 16"H
GVWOR12X18	12"W x 18"H
GVWOR12X20	12"W x 20"H
GVWOR12X22	12"W x 22"H
GVWOR12X24	12"W x 24"H
GVWOR12X26	12"W x 26"H
GVWOR12X28	12"W x 28"H
GVWOR12X30	12"W x 30"H
GVWOR12X32	12"W x 32"H
GVWOR12X34	12"W x 34"H
GVWOR12X36	12"W x 36"H
GVWOR16X12	16"W x 12"H
GVWOR16X14	16"W x 14"H
GVWOR16X16	16"W x 16"H
GVWOR16X18	16"W x 18"H
GVWOR16X20	16"W x 20"H
GVWOR16X22	16"W x 22"H
GVWOR16X24	16"W x 24"H
GVWOR16X26	16"W x 26"H
GVWOR16X28	16"W x 28"H
GVWOR16X30	16"W x 30"H

Part Number	Rough Opening Dimensions	Part Number	Rough Opening Dimensions
GVWOR16X32	16"W x 32"H	GVWOR24X32	24"W x 32"H
GVWOR16X34	16"W x 34"H	GVWOR24X34	24"W x 34"H
GVWOR16X36	16"W x 36"H	GVWOR24X36	24"W x 36"H
GVWOR18X12	18"W x 12"H	GVWOR30X12	30"W x 12"H
GVWOR18X14	18"W x 14"H	GVWOR30X14	30"W x 14"H
GVWOR18X16	18"W x 16"H	GVWOR30X16	30"W x 16"H
GVWOR18X18	18"W x 18"H	GVWOR30X18	30"W x 18"H
GVWOR18X20	18"W x 20"H	GVWOR30X20	30"W x 20"H
GVWOR18X22	18"W x 22"H	GVWOR30X22	30"W x 22"H
GVWOR18X24	18"W x 24"H	GVWOR30X24	30"W x 24"H
GVWOR18X26	18"W x 26"H	GVWOR30X26	30"W x 26"H
GVWOR18X28	18"W x 28"H	GVWOR30X28	30"W x 28"H
GVWOR18X30	18"W x 30"H	GVWOR30X30	30"W x 30"H
GVWOR18X32	18"W x 32"H	GVWOR30X32	30"W x 32"H
GVWOR18X34	18"W x 34"H	GVWOR30X34	30"W x 34"H
GVWOR18X36	18"W x 36"H	GVWOR30X36	30"W x 36"H
GVWOR20X12	20"W x 12"H	GVWOR36X12	36"W x 12"H
GVWOR20X14	20"W x 14"H	GVWOR36X14	36"W x 14"H
GVWOR20X16	20"W x 16"H	GVWOR36X16	36"W x 16"H
GVWOR20X18	20"W x 18"H	GVWOR36X18	36"W x 18"H
GVWOR20X20	20"W x 20"H	GVWOR36X20	36"W x 20"H
GVWOR20X22	20"W x 22"H	GVWOR36X22	36"W x 22"H
GVWOR20X24	20"W x 24"H	GVWOR36X24	36"W x 24"H
GVWOR20X26	20"W x 26"H	GVWOR36X26	36"W x 26"H
GVWOR20X28	20"W x 28"H	GVWOR36X28	36"W x 28"H
GVWOR20X30	20"W x 30"H	GVWOR36X30	36"W x 30"H
GVWOR20X32	20"W x 32"H	GVWOR36X32	36"W x 32"H
GVWOR20X34	20"W x 34"H	GVWOR36X34	36"W x 34"H
GVWOR20X36	20"W x 36"H	GVWOR36X36	36"W x 36"H
GVWOR24X12	24"W x 12"H		
GVWOR24X14	24"W x 14"H		
GVWOR24X16	24"W x 16"H		
GVWOR24X18	24"W x 18"H		
GVWOR24X20	24"W x 20"H		
GVWOR24X22	24"W x 22"H		
GVWOR24X24	24"W x 24"H		
GVWOR24X26	24"W x 26"H		
GVWOR24X28	24"W x 28"H		
GVWOR24X30	24"W x 30"H		

WOOD GABLE VENTS

Half Peaked Top Left Gable Vents



part number

GVWPL

Part Number	Rough Opening Dimensions
GVWPL12X12	12"W x 12"H
GVWPL12X14	12"W x 14"H
GVWPL12X16	12"W x 16"H
GVWPL12X18	12"W x 18"H
GVWPL12X20	12"W x 20"H
GVWPL12X22	12"W x 22"H
GVWPL12X24	12"W x 24"H
GVWPL12X26	12"W x 26"H
GVWPL12X28	12"W x 28"H
GVWPL12X30	12"W x 30"H
GVWPL12X32	12"W x 32"H
GVWPL12X34	12"W x 34"H
GVWPL12X36	12"W x 36"H
GVWPL16X12	16"W x 12"H
GVWPL16X14	16"W x 14"H
GVWPL16X16	16"W x 16"H
GVWPL16X18	16"W x 18"H
GVWPL16X20	16"W x 20"H
GVWPL16X22	16"W x 22"H
GVWPL16X24	16"W x 24"H
GVWPL16X26	16"W x 26"H
GVWPL16X28	16"W x 28"H
GVWPL16X30	16"W x 30"H

Part Number	Rough Opening Dimensions
GVWPL16X32	16"W x 32"H
GVWPL16X34	16"W x 34"H
GVWPL16X36	16"W x 36"H
GVWPL18X12	18"W x 12"H
GVWPL18X14	18"W x 14"H
GVWPL18X16	18"W x 16"H
GVWPL18X18	18"W x 18"H
GVWPL18X20	18"W x 20"H
GVWPL18X22	18"W x 22"H
GVWPL18X24	18"W x 24"H
GVWPL18X26	18"W x 26"H
GVWPL18X28	18"W x 28"H
GVWPL18X30	18"W x 30"H
GVWPL18X32	18"W x 32"H
GVWPL18X34	18"W x 34"H
GVWPL18X36	18"W x 36"H
GVWPL20X12	20"W x 12"H
GVWPL20X14	20"W x 14"H
GVWPL20X16	20"W x 16"H
GVWPL20X18	20"W x 18"H
GVWPL20X20	20"W x 20"H
GVWPL20X22	20"W x 22"H
GVWPL20X24	20"W x 24"H
GVWPL20X26	20"W x 26"H
GVWPL20X28	20"W x 28"H
GVWPL20X30	20"W x 30"H
GVWPL20X32	20"W x 32"H
GVWPL20X34	20"W x 34"H
GVWPL20X36	20"W x 36"H
GVWPL24X12	24"W x 12"H
GVWPL24X14	24"W x 14"H
GVWPL24X16	24"W x 16"H
GVWPL24X18	24"W x 18"H
GVWPL24X20	24"W x 20"H
GVWPL24X22	24"W x 22"H
GVWPL24X24	24"W x 24"H
GVWPL24X26	24"W x 26"H
GVWPL24X28	24"W x 28"H
GVWPL24X30	24"W x 30"H

Part Number	Rough Opening Dimensions
GVWPL24X32	24"W x 32"H
GVWPL24X34	24"W x 34"H
GVWPL24X36	24"W x 36"H
GVWPL30X12	30"W x 12"H
GVWPL30X14	30"W x 14"H
GVWPL30X16	30"W x 16"H
GVWPL30X18	30"W x 18"H
GVWPL30X20	30"W x 20"H
GVWPL30X22	30"W x 22"H
GVWPL30X24	30"W x 24"H
GVWPL30X26	30"W x 26"H
GVWPL30X28	30"W x 28"H
GVWPL30X30	30"W x 30"H
GVWPL30X32	30"W x 32"H
GVWPL30X34	30"W x 34"H
GVWPL30X36	30"W x 36"H
GVWPL36X12	36"W x 12"H
GVWPL36X14	36"W x 14"H
GVWPL36X16	36"W x 16"H
GVWPL36X18	36"W x 18"H
GVWPL36X20	36"W x 20"H
GVWPL36X22	36"W x 22"H
GVWPL36X24	36"W x 24"H
GVWPL36X26	36"W x 26"H
GVWPL36X28	36"W x 28"H
GVWPL36X30	36"W x 30"H
GVWPL36X32	36"W x 32"H
GVWPL36X34	36"W x 34"H
GVWPL36X36	36"W x 36"H

Half Peaked Top Right Gable Vents



Make sure to choose a pitch for this style! We make them all!

part number

GVWPR

Part Number	Rough Opening Dimensions
GVWPR12X12	12"W x 12"H
GVWPR12X14	12"W x 14"H
GVWPR12X16	12"W x 16"H
GVWPR12X18	12"W x 18"H
GVWPR12X20	12"W x 20"H
GVWPR12X22	12"W x 22"H
GVWPR12X24	12"W x 24"H
GVWPR12X26	12"W x 26"H
GVWPR12X28	12"W x 28"H
GVWPR12X30	12"W x 30"H
GVWPR12X32	12"W x 32"H
GVWPR12X34	12"W x 34"H
GVWPR12X36	12"W x 36"H
GVWPR16X12	16"W x 12"H
GVWPR16X14	16"W x 14"H
GVWPR16X16	16"W x 16"H
GVWPR16X18	16"W x 18"H
GVWPR16X20	16"W x 20"H
GVWPR16X22	16"W x 22"H
GVWPR16X24	16"W x 24"H
GVWPR16X26	16"W x 26"H
GVWPR16X28	16"W x 28"H
GVWPR16X30	16"W x 30"H

Part Number	Rough Opening Dimensions
GVWPR16X32	16"W x 32"H
GVWPR16X34	16"W x 34"H
GVWPR16X36	16"W x 36"H
GVWPR18X12	18"W x 12"H
GVWPR18X14	18"W x 14"H
GVWPR18X16	18"W x 16"H
GVWPR18X18	18"W x 18"H
GVWPR18X20	18"W x 20"H
GVWPR18X22	18"W x 22"H
GVWPR18X24	18"W x 24"H
GVWPR18X26	18"W x 26"H
GVWPR18X28	18"W x 28"H
GVWPR18X30	18"W x 30"H
GVWPR18X32	18"W x 32"H
GVWPR18X34	18"W x 34"H
GVWPR18X36	18"W x 36"H
GVWPR20X12	20"W x 12"H
GVWPR20X14	20"W x 14"H
GVWPR20X16	20"W x 16"H
GVWPR20X18	20"W x 18"H
GVWPR20X20	20"W x 20"H
GVWPR20X22	20"W x 22"H
GVWPR20X24	20"W x 24"H
GVWPR20X26	20"W x 26"H
GVWPR20X28	20"W x 28"H
GVWPR20X30	20"W x 30"H
GVWPR20X32	20"W x 32"H
GVWPR20X34	20"W x 34"H
GVWPR20X36	20"W x 36"H
GVWPR24X12	24"W x 12"H
GVWPR24X14	24"W x 14"H
GVWPR24X16	24"W x 16"H
GVWPR24X18	24"W x 18"H
GVWPR24X20	24"W x 20"H
GVWPR24X22	24"W x 22"H
GVWPR24X24	24"W x 24"H
GVWPR24X26	24"W x 26"H
GVWPR24X28	24"W x 28"H
GVWPR24X30	24"W x 30"H

Part Number	Rough Opening Dimensions
GVWPR24X32	24"W x 32"H
GVWPR24X34	24"W x 34"H
GVWPR24X36	24"W x 36"H
GVWPR30X12	30"W x 12"H
GVWPR30X14	30"W x 14"H
GVWPR30X16	30"W x 16"H
GVWPR30X18	30"W x 18"H
GVWPR30X20	30"W x 20"H
GVWPR30X22	30"W x 22"H
GVWPR30X24	30"W x 24"H
GVWPR30X26	30"W x 26"H
GVWPR30X28	30"W x 28"H
GVWPR30X30	30"W x 30"H
GVWPR30X32	30"W x 32"H
GVWPR30X34	30"W x 34"H
GVWPR30X36	30"W x 36"H
GVWPR36X12	36"W x 12"H
GVWPR36X14	36"W x 14"H
GVWPR36X16	36"W x 16"H
GVWPR36X18	36"W x 18"H
GVWPR36X20	36"W x 20"H
GVWPR36X22	36"W x 22"H
GVWPR36X24	36"W x 24"H
GVWPR36X26	36"W x 26"H
GVWPR36X28	36"W x 28"H
GVWPR36X30	36"W x 30"H
GVWPR36X32	36"W x 32"H
GVWPR36X34	36"W x 34"H
GVWPR36X36	36"W x 36"H

RUSTIC CORBELS, BRACKETS, BRACES & OUTLOOKERS



CORBELS, BRACKETS, BRACES, OUTLOOKERS

Our Rustic Collection is an instant classic. Our Rustic wood millwork utilizes technologies of today to build the ‘log and timber’ wood products that have been in architecture for centuries. Because our products are not kiln dried, each item in our Rustic Collection is 100% unique and will contain the natural variations that the wood species offers. Your wood bracket, corbel, rafter tail, or gable vent will contain unique colors, grains, textures, knots, sapwood, and heart wood content as well as possible sap bleeding, and even natural checking, splitting and cracks. These natural variations are what make the Rustic Collection stand out from the rest as truly natural wood products.

Largest Collection



Custom Sizes



Hand-Crafted



Unique Variations



Unlimited Sizes



Rustic Look



Made in the USA

ROUGH SAWN SMOOTH

ROUGH SAWN OR SMOOTH

The smooth finish Cedar or Pine is milled to perfection in our state-of-the-art wood shop. The smooth finish vents are also the perfect option if you plan on painting them. The rough-sawn finish offers a natural rustic look. The rough sawn vents are timeless, offering the saw-textured surface obtained during the milling process that give you the look of freshly cut lumber.

WOOD SPECIES

We offer our vents in both traditional Pine or durable Cedar. All of our wood is carefully chosen and hand inspected before being assembled into your vent. After each vent is made, it is again inspected to ensure you receive only the highest quality product on the market.

UNFINISHED OR PRIMED

You have the choice of ordering an unfinished gable vent or a primed one. If you prefer the natural look of freshly cut wood, unfinished is for you. If you prefer to paint your vent, we will prime it for you with two coats of high quality exterior grade primer.



SMOOTH
DOUGLAS FIR



ROUGH SAWN
DOUGLAS FIR

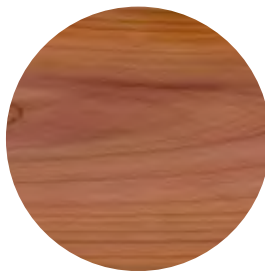

SMOOTH WESTERN
RED CEDAR



ROUGH SAWN
WESTERN RED CEDAR



HAND-HEWN

RUSTIC WOOD CORBELS



CARMEL STYLE **CAROO**



HUNTINGTON STYLE **HUNOO**



MEDITERRANEAN STYLE **MEDOO**



MONTEREY STYLE **MONOO**



DEL MONTE STYLE **DELOO**



ALPINE STYLE **ALPPO**

Part Number	Size	Rough or Smooth	Wood Species
COR04X06X06****	4"W x 6"D x 6"H	R or S*	WR or DF**
COR04X06X10****	4"W x 6"D x 10"H	R or S*	WR or DF**
COR04X06X14****	4"W x 6"D x 14"H	R or S*	WR or DF**
COR06X06X06****	6"W x 6"D x 6"H	R or S*	WR or DF**
COR06X06X10****	6"W x 6"D x 10"H	R or S*	WR or DF**
COR06X06X14****	6"W x 6"D x 14"H	R or S*	WR or DF**
COR04X08X08****	4"W x 8"D x 8"H	R or S*	WR or DF**
COR04X08X12****	4"W x 8"D x 12"H	R or S*	WR or DF**
COR04X08X16****	4"W x 8"D x 16"H	R or S*	WR or DF**
COR04X08X20****	4"W x 8"D x 20"H	R or S*	WR or DF**
COR04X08X24****	4"W x 8"D x 24"H	R or S*	WR or DF**
COR06X08X08****	6"W x 8"D x 8"H	R or S*	WR or DF**
COR06X08X12****	6"W x 8"D x 12"H	R or S*	WR or DF**
COR06X08X16****	6"W x 8"D x 16"H	R or S*	WR or DF**
COR06X08X20****	6"W x 8"D x 20"H	R or S*	WR or DF**
COR06X08X24****	6"W x 8"D x 24"H	R or S*	WR or DF**
COR04X10X10****	4"W x 10"D x 10"H	R or S*	WR or DF**
COR04X10X14****	4"W x 10"D x 14"H	R or S*	WR or DF**

RUSTIC WOOD CORBELS

PESCADERO STYLE **PECOO**



YORKTOWN STYLE **YOROO**



CRESTLINE STYLE **CREOO**



NEWPORT STYLE **NEWOO**



NEW BRIGHTON STYLE **NEBOO**



RIDGEWOOD STYLE **RIDOO**



Part Number	Size	Rough or Smooth	Wood Species
COR04X10X18*****	4"W x 10"D x 18"H	R or S*	WR or DF**
COR04X10X22*****	4"W x 10"D x 22"H	R or S*	WR or DF**
COR04X10X26*****	4"W x 10"D x 26"H	R or S*	WR or DF**
COR06X10X10*****	6"W x 10"D x 10"H	R or S*	WR or DF**
COR06X10X14*****	6"W x 10"D x 14"H	R or S*	WR or DF**
COR06X10X18*****	6"W x 10"D x 18"H	R or S*	WR or DF**
COR06X10X22*****	6"W x 10"D x 22"H	R or S*	WR or DF**
COR06X10X26*****	6"W x 10"D x 26"H	R or S*	WR or DF**
COR04X12X12*****	4"W x 12"D x 12"H	R or S*	WR or DF**
COR04X12X16*****	4"W x 12"D x 16"H	R or S*	WR or DF**
COR04X12X20*****	4"W x 12"D x 20"H	R or S*	WR or DF**
COR04X12X24*****	4"W x 12"D x 24"H	R or S	WR or DF**
COR04X12X28*****	4"W x 12"D x 28"H	R or S	WR or DF**
COR06X12X12*****	6"W x 12"D x 12"H	R or S	WR or DF**
COR06X12X16*****	6"W x 12"D x 16"H	R or S	WR or DF**
COR06X12X20*****	6"W x 12"D x 20"H	R or S	WR or DF**
COR06X12X24*****	6"W x 12"D x 24"H	R or S	WR or DF**
COR06X12X28*****	6"W x 12"D x 28"H	R or S	WR or DF**

RUSTIC WOOD CORBELS WITH BACKPLATE



CARMEL STYLE **CARO1**



HUNTINGTON STYLE **HUNO1**



MEDITERRANEAN STYLE **MEDO1**



MONTEREY STYLE **MONO1**



DEL MONTE STYLE **DELO1**



ALPINE STYLE **ALPO1**

Part Number	Size	Rough or Smooth	Wood Species
COR06X08X08	6"W x 8"D x 8"H	R or S	WR or DF
COR06X08X12	6"W x 8"D x 12"H	R or S	WR or DF
COR06X08X16	6"W x 8"D x 16"H	R or S	WR or DF
COR08X08X08	8"W x 8"D x 8"H	R or S	WR or DF
COR08X08X12	8"W x 8"D x 12"H	R or S	WR or DF
COR08X08X16	8"W x 8"D x 16"H	R or S	WR or DF
COR06X10X10	6"W x 10"D x 10"H	R or S	WR or DF
COR06X10X14	6"W x 10"D x 14"H	R or S	WR or DF
COR06X10X18	6"W x 10"D x 18"H	R or S	WR or DF
COR06X10X22	6"W x 10"D x 22"H	R or S	WR or DF
COR06X10X26	6"W x 10"D x 26"H	R or S	WR or DF
COR08X10X10	8"W x 10"D x 10"H	R or S	WR or DF
COR08X10X14	8"W x 10"D x 14"H	R or S	WR or DF
COR08X10X18	8"W x 10"D x 18"H	R or S	WR or DF
COR08X10X22	8"W x 10"D x 22"H	R or S	WR or DF
COR08X10X26	8"W x 10"D x 26"H	R or S	WR or DF
COR06X12X12	6"W x 12"D x 12"H	R or S	WR or DF
COR06X12X16	6"W x 12"D x 16"H	R or S	WR or DF

RUSTIC WOOD CORBELS WITH BACKPLATE

PESCADERO STYLE PECO1



YORKTOWN STYLE YORO1



CRESTLINE STYLE CREO1



NEWPORT STYLE NEWO1



NEW BRIGHTON STYLE NEBO1



RIDGEWOOD STYLE RIDO1



Part Number	Size	Rough or Smooth	Wood Species
COR06X12X20	6"W x 12"D x 20"H	R or S	WR or DF
COR06X12X24	6"W x 12"D x 24"H	R or S	WR or DF
COR06X12X28	6"W x 12"D x 28"H	R or S	WR or DF
COR08X12X12	8"W x 12"D x 12"H	R or S	WR or DF
COR08X12X16	8"W x 12"D x 16"H	R or S	WR or DF
COR08X12X20	8"W x 12"D x 20"H	R or S	WR or DF
COR08X12X24	8"W x 12"D x 24"H	R or S	WR or DF
COR08X12X28	8"W x 12"D x 28"H	R or S	WR or DF
COR06X14X14	6"W x 14"D x 14"H	R or S	WR or DF
COR06X14X18	6"W x 14"D x 18"H	R or S	WR or DF
COR06X14X22	6"W x 14"D x 22"H	R or S	WR or DF
COR06X14X26	6"W x 14"D x 26"H	R or S	WR or DF
COR06X14X30	6"W x 14"D x 30"H	R or S	WR or DF
COR08X14X14	8"W x 14"D x 14"H	R or S	WR or DF
COR08X14X18	8"W x 14"D x 18"H	R or S	WR or DF
COR08X14X22	8"W x 14"D x 22"H	R or S	WR or DF
COR08X14X26	8"W x 14"D x 26"H	R or S	WR or DF
COR08X14X30	8"W x 14"D x 30"H	R or S	WR or DF

RUSTIC WOOD BRACES



Part Number	Size	Rough or Smooth	Wood Species
BRC04X10X10	4"W x 10"D x 10"H	R or S	WR or DF
BRC04X10X14	4"W x 10"D x 14"H	R or S	WR or DF
BRC04X10X18	4"W x 10"D x 18"H	R or S	WR or DF
BRC04X12X12	4"W x 12"D x 12"H	R or S	WR or DF
BRC04X12X16	4"W x 12"D x 16"H	R or S	WR or DF
BRC04X12X20	4"W x 12"D x 20"H	R or S	WR or DF
BRC04X12X24	4"W x 12"D x 24"H	R or S	WR or DF
BRC04X14X14	4"W x 14"D x 14"H	R or S	WR or DF
BRC04X14X18	4"W x 14"D x 18"H	R or S	WR or DF
BRC04X14X22	4"W x 14"D x 22"H	R or S	WR or DF
BRC04X14X26	4"W x 14"D x 26"H	R or S	WR or DF
BRC04X16X16	4"W x 16"D x 16"H	R or S	WR or DF
BRC04X16X20	4"W x 16"D x 20"H	R or S	WR or DF
BRC04X16X24	4"W x 16"D x 24"H	R or S	WR or DF
BRC04X16X28	4"W x 16"D x 28"H	R or S	WR or DF
BRC04X18X18	4"W x 18"D x 18"H	R or S	WR or DF
BRC04X18X22	4"W x 18"D x 22"H	R or S	WR or DF
BRC04X18X26	4"W x 18"D x 26"H	R or S	WR or DF
BRC04X20X20	4"W x 20"D x 20"H	R or S	WR or DF
BRC04X20X24	4"W x 20"D x 24"H	R or S	WR or DF
BRC04X20X28	4"W x 20"D x 28"H	R or S	WR or DF
BRC04X22X22	4"W x 22"D x 22"H	R or S	WR or DF
BRC04X22X26	4"W x 22"D x 26"H	R or S	WR or DF
BRC04X22X30	4"W x 22"D x 30"H	R or S	WR or DF
BRC04X24X24	4"W x 24"D x 24"H	R or S	WR or DF
BRC04X24X28	4"W x 24"D x 28"H	R or S	WR or DF
BRC04X24X36	4"W x 24"D x 36"H	R or S	WR or DF
BRC04X30X30	4"W x 30"D x 30"H	R or S	WR or DF
BRC04X30X36	4"W x 30"D x 36"H	R or S	WR or DF
BRC04X36X36	4"W x 36"D x 36"H	R or S	WR or DF

RUSTIC WOOD BRACES



Part Number	Size	Rough or Smooth	Wood Species
BRC06X10X10	6"W x 10"D x 10"H	R or S	WR or DF
BRC06X10X14	6"W x 10"D x 14"H	R or S	WR or DF
BRC06X10X18	6"W x 10"D x 18"H	R or S	WR or DF
BRC06X12X12	6"W x 12"D x 12"H	R or S	WR or DF
BRC06X12X16	6"W x 12"D x 16"H	R or S	WR or DF
BRC06X12X20	6"W x 12"D x 20"H	R or S	WR or DF
BRC06X12X24	6"W x 12"D x 24"H	R or S	WR or DF
BRC06X14X14	6"W x 14"D x 14"H	R or S	WR or DF
BRC06X14X18	6"W x 14"D x 18"H	R or S	WR or DF
BRC06X14X22	6"W x 14"D x 22"H	R or S	WR or DF
BRC06X14X26	6"W x 14"D x 26"H	R or S	WR or DF
BRC06X16X16	6"W x 16"D x 16"H	R or S	WR or DF
BRC06X16X20	6"W x 16"D x 20"H	R or S	WR or DF
BRC06X16X24	6"W x 16"D x 24"H	R or S	WR or DF
BRC06X16X28	6"W x 16"D x 28"H	R or S	WR or DF
BRC06X18X18	6"W x 18"D x 18"H	R or S	WR or DF
BRC06X18X22	6"W x 18"D x 22"H	R or S	WR or DF
BRC06X18X26	6"W x 18"D x 26"H	R or S	WR or DF
BRC06X20X20	6"W x 20"D x 20"H	R or S	WR or DF
BRC06X20X24	6"W x 20"D x 24"H	R or S	WR or DF
BRC06X20X28	6"W x 20"D x 28"H	R or S	WR or DF
BRC06X22X22	6"W x 22"D x 22"H	R or S	WR or DF
BRC06X22X26	6"W x 22"D x 26"H	R or S	WR or DF
BRC06X22X30	6"W x 22"D x 30"H	R or S	WR or DF
BRC06X24X24	6"W x 24"D x 24"H	R or S	WR or DF
BRC06X24X28	6"W x 24"D x 28"H	R or S	WR or DF
BRC06X24X36	6"W x 24"D x 36"H	R or S	WR or DF
BRC06X30X30	6"W x 30"D x 30"H	R or S	WR or DF
BRC06X30X36	6"W x 30"D x 36"H	R or S	WR or DF
BRC06X36X36	6"W x 36"D x 36"H	R or S	WR or DF

TRADITIONAL STYLE RUSTIC WOOD BRACKETS



BAIBOA STYLE BOAO1



IMPERIAL STYLE IMP01



MERCED STYLE MRCO1



OLYMPIC STYLE OLY01

Part Number	Size	Rough or Smooth	Wood Species
BKT04X18X18	4"W x 18"D x 18"H	R or S	WR or DF
BKT04X18X22	4"W x 18"D x 22"H	R or S	WR or DF
BKT04X18X26	4"W x 18"D x 26"H	R or S	WR or DF
BKT04X20X20	4"W x 20"D x 20"H	R or S	WR or DF
BKT04X20X24	4"W x 20"D x 24"H	R or S	WR or DF
BKT04X20X28	4"W x 20"D x 28"H	R or S	WR or DF
BKT04X20X32	4"W x 20"D x 32"H	R or S	WR or DF
BKT04X22X22	4"W x 22"D x 22"H	R or S	WR or DF
BKT04X22X26	4"W x 22"D x 26"H	R or S	WR or DF
BKT04X22X30	4"W x 22"D x 30"H	R or S	WR or DF
BKT04X22X34	4"W x 22"D x 34"H	R or S	WR or DF
BKT04X24X24	4"W x 24"D x 24"H	R or S	WR or DF
BKT04X24X28	4"W x 24"D x 28"H	R or S	WR or DF
BKT04X24X32	4"W x 24"D x 32"H	R or S	WR or DF
BKT04X24X36	4"W x 24"D x 36"H	R or S	WR or DF
BKT04X26X26	4"W x 26"D x 26"H	R or S	WR or DF
BKT04X26X30	4"W x 26"D x 30"H	R or S	WR or DF
BKT04X26X34	4"W x 26"D x 34"H	R or S	WR or DF
BKT04X28X28	4"W x 28"D x 28"H	R or S	WR or DF
BKT04X28X32	4"W x 28"D x 32"H	R or S	WR or DF
BKT04X28X36	4"W x 28"D x 36"H	R or S	WR or DF
BKT04X30X30	4"W x 30"D x 30"H	R or S	WR or DF
BKT04X30X34	4"W x 30"D x 34"H	R or S	WR or DF
BKT04X30X38	4"W x 30"D x 38"H	R or S	WR or DF
BKT04X32X32	4"W x 32"D x 32"H	R or S	WR or DF
BKT04X32X36	4"W x 32"D x 36"H	R or S	WR or DF
BKT04X32X44	4"W x 32"D x 44"H	R or S	WR or DF
BKT04X38X38	4"W x 38"D x 38"H	R or S	WR or DF
BKT04X38X46	4"W x 38"D x 46"H	R or S	WR or DF
BKT04X44X44	4"W x 44"D x 44"H	R or S	WR or DF

TRADITIONAL STYLE RUSTIC WOOD BRACKETS



FUNSTON STYLE **FST01**



THORTON STYLE **TH01**



WESTLAKE STYLE **WT01**



TRADITIONAL STYLE **TRA01**



Part Number	Size	Rough or Smooth	Wood Species
BKT06X18X18	6"W x 18"D x 18"H	R or S	WR or DF
BKT06X18X22	6"W x 18"D x 22"H	R or S	WR or DF
BKT06X18X26	6"W x 18"D x 26"H	R or S	WR or DF
BKT06X20X20	6"W x 20"D x 20"H	R or S	WR or DF
BKT06X20X24	6"W x 20"D x 24"H	R or S	WR or DF
BKT06X20X28	6"W x 20"D x 28"H	R or S	WR or DF
BKT06X20X32	6"W x 20"D x 32"H	R or S	WR or DF
BKT06X22X22	6"W x 22"D x 22"H	R or S	WR or DF
BKT06X22X26	6"W x 22"D x 26"H	R or S	WR or DF
BKT06X22X30	6"W x 22"D x 30"H	R or S	WR or DF
BKT06X22X34	6"W x 22"D x 34"H	R or S	WR or DF
BKT06X24X24	6"W x 24"D x 24"H	R or S	WR or DF
BKT06X24X28	6"W x 24"D x 28"H	R or S	WR or DF
BKT06X24X32	6"W x 24"D x 32"H	R or S	WR or DF
BKT06X24X36	6"W x 24"D x 36"H	R or S	WR or DF
BKT06X26X26	6"W x 26"D x 26"H	R or S	WR or DF
BKT06X26X30	6"W x 26"D x 30"H	R or S	WR or DF
BKT06X26X34	6"W x 26"D x 34"H	R or S	WR or DF
BKT06X28X28	6"W x 28"D x 28"H	R or S	WR or DF
BKT06X28X32	6"W x 28"D x 32"H	R or S	WR or DF
BKT06X28X36	6"W x 28"D x 36"H	R or S	WR or DF
BKT06X30X30	6"W x 30"D x 30"H	R or S	WR or DF
BKT06X30X34	6"W x 30"D x 34"H	R or S	WR or DF
BKT06X30X38	6"W x 30"D x 38"H	R or S	WR or DF
BKT06X32X32	6"W x 32"D x 32"H	R or S	WR or DF
BKT06X32X36	6"W x 32"D x 36"H	R or S	WR or DF
BKT06X32X44	6"W x 32"D x 44"H	R or S	WR or DF
BKT06X38X38	6"W x 38"D x 38"H	R or S	WR or DF
BKT06X38X46	6"W x 38"D x 46"H	R or S	WR or DF
BKT06X44X44	6"W x 44"D x 44"H	R or S	WR or DF

ARTS & CRAFTS STYLE RUSTIC WOOD BRACKETS



BALBOA STYLE **BOAO3**



IMPERIAL STYLE **IMPO3**



MERCED STYLE **MRCO3**



OLYMPIC STYLE **OLYO3**



Part Number	Size	Rough or Smooth	Wood Species
BKT04X18X18	4"W x 18"D x 18"H	R or S	WR or DF
BKT04X18X22	4"W x 18"D x 22"H	R or S	WR or DF
BKT04X18X26	4"W x 18"D x 26"H	R or S	WR or DF
BKT04X20X20	4"W x 20"D x 20"H	R or S	WR or DF
BKT04X20X24	4"W x 20"D x 24"H	R or S	WR or DF
BKT04X20X28	4"W x 20"D x 28"H	R or S	WR or DF
BKT04X20X32	4"W x 20"D x 32"H	R or S	WR or DF
BKT04X22X22	4"W x 22"D x 22"H	R or S	WR or DF
BKT04X22X26	4"W x 22"D x 26"H	R or S	WR or DF
BKT04X22X30	4"W x 22"D x 30"H	R or S	WR or DF
BKT04X22X34	4"W x 22"D x 34"H	R or S	WR or DF
BKT04X24X24	4"W x 24"D x 24"H	R or S	WR or DF
BKT04X24X28	4"W x 24"D x 28"H	R or S	WR or DF
BKT04X24X32	4"W x 24"D x 32"H	R or S	WR or DF
BKT04X24X36	4"W x 24"D x 36"H	R or S	WR or DF
BKT04X26X26	4"W x 26"D x 26"H	R or S	WR or DF
BKT04X26X30	4"W x 26"D x 30"H	R or S	WR or DF
BKT04X26X34	4"W x 26"D x 34"H	R or S	WR or DF
BKT04X28X28	4"W x 28"D x 28"H	R or S	WR or DF
BKT04X28X32	4"W x 28"D x 32"H	R or S	WR or DF
BKT04X28X36	4"W x 28"D x 36"H	R or S	WR or DF
BKT04X30X30	4"W x 30"D x 30"H	R or S	WR or DF
BKT04X30X34	4"W x 30"D x 34"H	R or S	WR or DF
BKT04X30X38	4"W x 30"D x 38"H	R or S	WR or DF
BKT04X32X32	4"W x 32"D x 32"H	R or S	WR or DF
BKT04X32X36	4"W x 32"D x 36"H	R or S	WR or DF
BKT04X32X44	4"W x 32"D x 44"H	R or S	WR or DF
BKT04X38X38	4"W x 38"D x 38"H	R or S	WR or DF
BKT04X38X46	4"W x 38"D x 46"H	R or S	WR or DF
BKT04X44X44	4"W x 44"D x 44"H	R or S	WR or DF

ARTS & CRAFTS STYLE RUSTIC WOOD BRACKETS



FUNSTON STYLE FSTO3



THORTON STYLE THRO3



WESTLAKE STYLE WTLO3



TRADITIONAL STYLE TRAO3



Part Number	Size	Rough or Smooth	Wood Species
BKT06X18X18	6"W x 18"D x 18"H	R or S	WR or DF
BKT06X18X22	6"W x 18"D x 22"H	R or S	WR or DF
BKT06X18X26	6"W x 18"D x 26"H	R or S	WR or DF
BKT06X20X20	6"W x 20"D x 20"H	R or S	WR or DF
BKT06X20X24	6"W x 20"D x 24"H	R or S	WR or DF
BKT06X20X28	6"W x 20"D x 28"H	R or S	WR or DF
BKT06X20X32	6"W x 20"D x 32"H	R or S	WR or DF
BKT06X22X22	6"W x 22"D x 22"H	R or S	WR or DF
BKT06X22X26	6"W x 22"D x 26"H	R or S	WR or DF
BKT06X22X30	6"W x 22"D x 30"H	R or S	WR or DF
BKT06X22X34	6"W x 22"D x 34"H	R or S	WR or DF
BKT06X24X24	6"W x 24"D x 24"H	R or S	WR or DF
BKT06X24X28	6"W x 24"D x 28"H	R or S	WR or DF
BKT06X24X32	6"W x 24"D x 32"H	R or S	WR or DF
BKT06X24X36	6"W x 24"D x 36"H	R or S	WR or DF
BKT06X26X26	6"W x 26"D x 26"H	R or S	WR or DF
BKT06X26X30	6"W x 26"D x 30"H	R or S	WR or DF
BKT06X26X34	6"W x 26"D x 34"H	R or S	WR or DF
BKT06X28X28	6"W x 28"D x 28"H	R or S	WR or DF
BKT06X28X32	6"W x 28"D x 32"H	R or S	WR or DF
BKT06X28X36	6"W x 28"D x 36"H	R or S	WR or DF
BKT06X30X30	6"W x 30"D x 30"H	R or S	WR or DF
BKT06X30X34	6"W x 30"D x 34"H	R or S	WR or DF
BKT06X30X38	6"W x 30"D x 38"H	R or S	WR or DF
BKT06X32X32	6"W x 32"D x 32"H	R or S	WR or DF
BKT06X32X36	6"W x 32"D x 36"H	R or S	WR or DF
BKT06X32X44	6"W x 32"D x 44"H	R or S	WR or DF
BKT06X38X38	6"W x 38"D x 38"H	R or S	WR or DF
BKT06X38X46	6"W x 38"D x 46"H	R or S	WR or DF
BKT06X44X44	6"W x 44"D x 44"H	R or S	WR or DF

CRAFTSMAN STYLE RUSTIC WOOD BRACKETS



BALBOA STYLE **BOA04**



IMPERIAL STYLE **IMP04**



MERCED STYLE **MRC04**



OLYMPIC STYLE **OLY04**

Part Number	Size	Rough or Smooth	Wood Species
BKT04X18X18	4"W x 18"D x 18"H	R or S	WR or DF
BKT04X18X22	4"W x 18"D x 22"H	R or S	WR or DF
BKT04X18X26	4"W x 18"D x 26"H	R or S	WR or DF
BKT04X20X20	4"W x 20"D x 20"H	R or S	WR or DF
BKT04X20X24	4"W x 20"D x 24"H	R or S	WR or DF
BKT04X20X28	4"W x 20"D x 28"H	R or S	WR or DF
BKT04X20X32	4"W x 20"D x 32"H	R or S	WR or DF
BKT04X22X22	4"W x 22"D x 22"H	R or S	WR or DF
BKT04X22X26	4"W x 22"D x 26"H	R or S	WR or DF
BKT04X22X30	4"W x 22"D x 30"H	R or S	WR or DF
BKT04X22X34	4"W x 22"D x 34"H	R or S	WR or DF
BKT04X24X24	4"W x 24"D x 24"H	R or S	WR or DF
BKT04X24X28	4"W x 24"D x 28"H	R or S	WR or DF
BKT04X24X32	4"W x 24"D x 32"H	R or S	WR or DF
BKT04X24X36	4"W x 24"D x 36"H	R or S	WR or DF
BKT04X26X26	4"W x 26"D x 26"H	R or S	WR or DF
BKT04X26X30	4"W x 26"D x 30"H	R or S	WR or DF
BKT04X26X34	4"W x 26"D x 34"H	R or S	WR or DF
BKT04X28X28	4"W x 28"D x 28"H	R or S	WR or DF
BKT04X28X32	4"W x 28"D x 32"H	R or S	WR or DF
BKT04X28X36	4"W x 28"D x 36"H	R or S	WR or DF
BKT04X30X30	4"W x 30"D x 30"H	R or S	WR or DF
BKT04X30X34	4"W x 30"D x 34"H	R or S	WR or DF
BKT04X30X38	4"W x 30"D x 38"H	R or S	WR or DF
BKT04X32X32	4"W x 32"D x 32"H	R or S	WR or DF
BKT04X32X36	4"W x 32"D x 36"H	R or S	WR or DF
BKT04X32X44	4"W x 32"D x 44"H	R or S	WR or DF
BKT04X38X38	4"W x 38"D x 38"H	R or S	WR or DF
BKT04X38X46	4"W x 38"D x 46"H	R or S	WR or DF
BKT04X44X44	4"W x 44"D x 44"H	R or S	WR or DF

CRAFTSMAN STYLE RUSTIC WOOD BRACKETS



FUNSTON STYLE FSTO4



THORTON STYLE THRO4



WESTLAKE STYLE WTLO4



TRADITIONAL STYLE TRA04



Part Number	Size	Rough or Smooth	Wood Species
BKT06X18X18	6"W x 18"D x 18"H	R or S	WR or DF
BKT06X18X22	6"W x 18"D x 22"H	R or S	WR or DF
BKT06X18X26	6"W x 18"D x 26"H	R or S	WR or DF
BKT06X20X20	6"W x 20"D x 20"H	R or S	WR or DF
BKT06X20X24	6"W x 20"D x 24"H	R or S	WR or DF
BKT06X20X28	6"W x 20"D x 28"H	R or S	WR or DF
BKT06X20X32	6"W x 20"D x 32"H	R or S	WR or DF
BKT06X22X22	6"W x 22"D x 22"H	R or S	WR or DF
BKT06X22X26	6"W x 22"D x 26"H	R or S	WR or DF
BKT06X22X30	6"W x 22"D x 30"H	R or S	WR or DF
BKT06X22X34	6"W x 22"D x 34"H	R or S	WR or DF
BKT06X24X24	6"W x 24"D x 24"H	R or S	WR or DF
BKT06X24X28	6"W x 24"D x 28"H	R or S	WR or DF
BKT06X24X32	6"W x 24"D x 32"H	R or S	WR or DF
BKT06X24X36	6"W x 24"D x 36"H	R or S	WR or DF
BKT06X26X26	6"W x 26"D x 26"H	R or S	WR or DF
BKT06X26X30	6"W x 26"D x 30"H	R or S	WR or DF
BKT06X26X34	6"W x 26"D x 34"H	R or S	WR or DF
BKT06X28X28	6"W x 28"D x 28"H	R or S	WR or DF
BKT06X28X32	6"W x 28"D x 32"H	R or S	WR or DF
BKT06X28X36	6"W x 28"D x 36"H	R or S	WR or DF
BKT06X30X30	6"W x 30"D x 30"H	R or S	WR or DF
BKT06X30X34	6"W x 30"D x 34"H	R or S	WR or DF
BKT06X30X38	6"W x 30"D x 38"H	R or S	WR or DF
BKT06X32X32	6"W x 32"D x 32"H	R or S	WR or DF
BKT06X32X36	6"W x 32"D x 36"H	R or S	WR or DF
BKT06X32X44	6"W x 32"D x 44"H	R or S	WR or DF
BKT06X38X38	6"W x 38"D x 38"H	R or S	WR or DF
BKT06X38X46	6"W x 38"D x 46"H	R or S	WR or DF
BKT06X44X44	6"W x 44"D x 44"H	R or S	WR or DF

TRADITIONAL STYLE RUSTIC WOOD OUTLOOKERS



OLYMPIC STYLE OLYO1



MERCED STYLE MRCO1



IMPERIAL STYLE IMPO1



BALBOA STYLE BOAO1

Part Number	Size	Rough or Smooth	Wood Species
OUT06X16X16	6"W x 16"D x 16"H	R or S	WR or DF
OUT06X16X20	6"W x 16"D x 20"H	R or S	WR or DF
OUT06X16X24	6"W x 16"D x 24"H	R or S	WR or DF
OUT06X18X18	6"W x 18"D x 18"H	R or S	WR or DF
OUT06X18X22	6"W x 18"D x 22"H	R or S	WR or DF
OUT06X18X26	6"W x 18"D x 26"H	R or S	WR or DF
OUT06X18X30	6"W x 18"D x 30"H	R or S	WR or DF
OUT06X20X20	6"W x 20"D x 20"H	R or S	WR or DF
OUT06X20X24	6"W x 20"D x 24"H	R or S	WR or DF
OUT06X20X28	6"W x 20"D x 28"H	R or S	WR or DF
OUT06X20X32	6"W x 20"D x 32"H	R or S	WR or DF
OUT06X22X22	6"W x 22"D x 22"H	R or S	WR or DF
OUT06X22X26	6"W x 22"D x 26"H	R or S	WR or DF
OUT06X22X30	6"W x 22"D x 30"H	R or S	WR or DF
OUT06X22X34	6"W x 22"D x 34"H	R or S	WR or DF
OUT06X24X24	6"W x 24"D x 24"H	R or S	WR or DF
OUT06X24X28	6"W x 24"D x 28"H	R or S	WR or DF
OUT06X24X32	6"W x 24"D x 32"H	R or S	WR or DF
OUT06X26X26	6"W x 26"D x 26"H	R or S	WR or DF
OUT06X26X30	6"W x 26"D x 30"H	R or S	WR or DF
OUT06X26X34	6"W x 26"D x 34"H	R or S	WR or DF
OUT06X28X28	6"W x 28"D x 28"H	R or S	WR or DF
OUT06X28X32	6"W x 28"D x 32"H	R or S	WR or DF
OUT06X28X36	6"W x 28"D x 36"H	R or S	WR or DF
OUT06X30X30	6"W x 30"D x 30"H	R or S	WR or DF
OUT06X30X34	6"W x 30"D x 34"H	R or S	WR or DF
OUT06X30X42	6"W x 30"D x 42"H	R or S	WR or DF
OUT06X36X36	6"W x 36"D x 36"H	R or S	WR or DF
OUT06X36X44	6"W x 36"D x 44"H	R or S	WR or DF
OUT06X42X42	6"W x 42"D x 42"H	R or S	WR or DF

TRADITIONAL STYLE RUSTIC WOOD OUTLOOKERS



FUNSTON STYLE FSTO1



THORTON STYLE THRO1



WESTLAKE STYLE WTLO1



TRADITIONAL STYLE TRA01



Part Number	Size	Rough or Smooth	Wood Species
OUT08X14X14	8"W x 14"D x 14"H	R or S	WR or DF
OUT08X14X18	8"W x 14"D x 18"H	R or S	WR or DF
OUT08X14X22	8"W x 14"D x 22"H	R or S	WR or DF
OUT08X16X16	8"W x 16"D x 16"H	R or S	WR or DF
OUT08X16X20	8"W x 16"D x 20"H	R or S	WR or DF
OUT08X16X24	8"W x 16"D x 24"H	R or S	WR or DF
OUT08X16X28	8"W x 16"D x 28"H	R or S	WR or DF
OUT08X18X18	8"W x 18"D x 18"H	R or S	WR or DF
OUT08X18X22	8"W x 18"D x 22"H	R or S	WR or DF
OUT08X18X26	8"W x 18"D x 26"H	R or S	WR or DF
OUT08X18X30	8"W x 18"D x 30"H	R or S	WR or DF
OUT08X20X20	8"W x 20"D x 20"H	R or S	WR or DF
OUT08X20X24	8"W x 20"D x 24"H	R or S	WR or DF
OUT08X20X28	8"W x 20"D x 28"H	R or S	WR or DF
OUT08X20X32	8"W x 20"D x 32"H	R or S	WR or DF
OUT08X22X22	8"W x 22"D x 22"H	R or S	WR or DF
OUT08X22X26	8"W x 22"D x 26"H	R or S	WR or DF
OUT08X22X30	8"W x 22"D x 30"H	R or S	WR or DF
OUT08X24X24	8"W x 24"D x 24"H	R or S	WR or DF
OUT08X24X28	8"W x 24"D x 28"H	R or S	WR or DF
OUT08X24X32	8"W x 24"D x 32"H	R or S	WR or DF
OUT08X26X26	8"W x 26"D x 26"H	R or S	WR or DF
OUT08X26X30	8"W x 26"D x 30"H	R or S	WR or DF
OUT08X26X34	8"W x 26"D x 34"H	R or S	WR or DF
OUT08X28X28	8"W x 28"D x 28"H	R or S	WR or DF
OUT08X28X32	8"W x 28"D x 32"H	R or S	WR or DF
OUT08X28X40	8"W x 28"D x 40"H	R or S	WR or DF
OUT08X34X34	8"W x 34"D x 34"H	R or S	WR or DF
OUT08X34X42	8"W x 34"D x 42"H	R or S	WR or DF
OUT08X40X40	8"W x 40"D x 40"H	R or S	WR or DF

ARTS & CRAFTS STYLE RUSTIC WOOD OUTLOOKERS



BALBOA STYLE **BOA03**



IMPERIAL STYLE **IMP03**



MERCED STYLE **MRC03**



OLYMPIC STYLE **OLY03**

Part Number	Size	Rough or Smooth	Wood Species
OUT06X16X16	6"W x 16"D x 16"H	R or S	WR or DF
OUT06X16X20	6"W x 16"D x 20"H	R or S	WR or DF
OUT06X16X24	6"W x 16"D x 24"H	R or S	WR or DF
OUT06X18X18	6"W x 18"D x 18"H	R or S	WR or DF
OUT06X18X22	6"W x 18"D x 22"H	R or S	WR or DF
OUT06X18X26	6"W x 18"D x 26"H	R or S	WR or DF
OUT06X18X30	6"W x 18"D x 30"H	R or S	WR or DF
OUT06X20X20	6"W x 20"D x 20"H	R or S	WR or DF
OUT06X20X24	6"W x 20"D x 24"H	R or S	WR or DF
OUT06X20X28	6"W x 20"D x 28"H	R or S	WR or DF
OUT06X20X32	6"W x 20"D x 32"H	R or S	WR or DF
OUT06X22X22	6"W x 22"D x 22"H	R or S	WR or DF
OUT06X22X26	6"W x 22"D x 26"H	R or S	WR or DF
OUT06X22X30	6"W x 22"D x 30"H	R or S	WR or DF
OUT06X22X34	6"W x 22"D x 34"H	R or S	WR or DF
OUT06X24X24	6"W x 24"D x 24"H	R or S	WR or DF
OUT06X24X28	6"W x 24"D x 28"H	R or S	WR or DF
OUT06X24X32	6"W x 24"D x 32"H	R or S	WR or DF
OUT06X26X26	6"W x 24"D x 26"H	R or S	WR or DF
OUT06X26X30	4"W x 26"D x 30"H	R or S	WR or DF
OUT06X26X34	6"W x 26"D x 34"H	R or S	WR or DF
OUT06X28X28	6"W x 28"D x 28"H	R or S	WR or DF
OUT06X28X32	6"W x 28"D x 32"H	R or S	WR or DF
OUT06X28X36	6"W x 28"D x 36"H	R or S	WR or DF
OUT06X30X30	6"W x 30"D x 30"H	R or S	WR or DF
OUT06X30X34	6"W x 30"D x 34"H	R or S	WR or DF
OUT06X30X42	6"W x 30"D x 42"H	R or S	WR or DF
OUT06X36X36	6"W x 36"D x 36"H	R or S	WR or DF
OUT06X36X44	6"W x 36"D x 44"H	R or S	WR or DF
OUT06X42X42	6"W x 42"D x 42"H	R or S	WR or DF

ARTS & CRAFTS STYLE RUSTIC WOOD OUTLOOKERS



Part Number	Size	Rough or Smooth	Wood Species
OUT08X14X14	8"W x 14"D x 14"H	R or S	WR or DF
OUT08X14X18	8"W x 14"D x 18"H	R or S	WR or DF
OUT08X14X22	8"W x 14"D x 22"H	R or S	WR or DF
OUT08X16X16	8"W x 16"D x 16"H	R or S	WR or DF
OUT08X16X20	8"W x 16"D x 20"H	R or S	WR or DF
OUT08X16X24	8"W x 16"D x 24"H	R or S	WR or DF
OUT08X16X28	8"W x 16"D x 28"H	R or S	WR or DF
OUT08X18X18	8"W x 18"D x 18"H	R or S	WR or DF
OUT08X18X22	8"W x 18"D x 22"H	R or S	WR or DF
OUT08X18X26	8"W x 18"D x 26"H	R or S	WR or DF
OUT08X18X30	8"W x 18"D x 30"H	R or S	WR or DF
OUT08X20X20	8"W x 20"D x 20"H	R or S	WR or DF
OUT08X20X24	8"W x 20"D x 24"H	R or S	WR or DF
OUT08X20X28	8"W x 20"D x 28"H	R or S	WR or DF
OUT08X20X32	8"W x 20"D x 32"H	R or S	WR or DF
OUT08X22X22	8"W x 22"D x 22"H	R or S	WR or DF
OUT08X22X26	8"W x 22"D x 26"H	R or S	WR or DF
OUT08X22X30	8"W x 22"D x 30"H	R or S	WR or DF
OUT08X24X24	8"W x 24"D x 24"H	R or S	WR or DF
OUT08X24X28	8"W x 24"D x 28"H	R or S	WR or DF
OUT08X24X32	6"W x 24"D x 32"H	R or S	WR or DF
OUT08X26X26	8"W x 26"D x 26"H	R or S	WR or DF
OUT08X26X30	8"W x 26"D x 30"H	R or S	WR or DF
OUT08X26X34	8"W x 26"D x 34"H	R or S	WR or DF
OUT08X28X28	8"W x 28"D x 28"H	R or S	WR or DF
OUT08X28X32	8"W x 28"D x 32"H	R or S	WR or DF
OUT08X28X40	8"W x 28"D x 40"H	R or S	WR or DF
OUT08X34X34	8"W x 34"D x 34"H	R or S	WR or DF
OUT08X34X42	8"W x 34"D x 42"H	R or S	WR or DF
OUT08X40X40	8"W x 40"D x 40"H	R or S	WR or DF

FUNSTON STYLE FSTO3



THORTON STYLE THRO3



WESTLAKE STYLE WTLO3



TRADITIONAL STYLE TRAO3



CRAFTSMAN STYLE RUSTIC WOOD OUTLOOKERS



BALBOA STYLE **BOA04**



IMPERIAL STYLE **IMP04**



MERCED STYLE **MRC04**



OLYMPIC STYLE **OLY04**

Part Number	Size	Rough or Smooth	Wood Species
OUT06X16X16*****	6"W x 16"D x 16"H	R or S*	WR or DF**
OUT06X16X20*****	6"W x 16"D x 20"H	R or S*	WR or DF**
OUT06X16X24*****	6"W x 16"D x 24"H	R or S*	WR or DF**
OUT06X18X18*****	6"W x 18"D x 18"H	R or S*	WR or DF**
OUT06X18X22*****	6"W x 18"D x 22"H	R or S*	WR or DF**
OUT06X18X26*****	6"W x 18"D x 26"H	R or S*	WR or DF**
OUT06X18X30*****	6"W x 18"D x 30"H	R or S*	WR or DF**
OUT06X20X20*****	6"W x 20"D x 20"H	R or S*	WR or DF**
OUT06X20X24*****	6"W x 20"D x 24"H	R or S*	WR or DF**
OUT06X20X28*****	6"W x 20"D x 28"H	R or S*	WR or DF**
OUT06X20X32*****	6"W x 20"D x 32"H	R or S*	WR or DF**
OUT06X22X22*****	6"W x 22"D x 22"H	R or S*	WR or DF**
OUT06X22X24*****	6"W x 22"D x 26"H	R or S*	WR or DF**
OUT06X22X32*****	6"W x 22"D x 30"H	R or S*	WR or DF**
OUT06X22X34*****	6"W x 22"D x 34"H	R or S*	WR or DF**
OUT06X24X24*****	6"W x 24"D x 24"H	R or S*	WR or DF**
OUT06X24X28*****	6"W x 24"D x 28"H	R or S*	WR or DF**
OUT06X24X32*****	6"W x 24"D x 32"H	R or S*	WR or DF**
OUT06X26X26*****	6"W x 26"D x 26"H	R or S*	WR or DF**
OUT06X26X30*****	6"W x 26"D x 30"H	R or S*	WR or DF**
OUT06X26X34*****	6"W x 26"D x 34"H	R or S*	WR or DF**
OUT06X28X28*****	6"W x 28"D x 28"H	R or S*	WR or DF**
OUT06X28X32*****	6"W x 28"D x 32"H	R or S*	WR or DF**
OUT06X28X36*****	6"W x 28"D x 36"H	R or S*	WR or DF**
OUT06X30X30*****	6"W x 30"D x 30"H	R or S*	WR or DF**
OUT06X30X34*****	6"W x 30"D x 34"H	R or S*	WR or DF**
OUT06X30X42*****	6"W x 30"D x 42"H	R or S*	WR or DF**
OUT06X36X36*****	6"W x 36"D x 36"H	R or S*	WR or DF**
OUT06X36X44*****	6"W x 36"D x 44"H	R or S*	WR or DF**
OUT06X42X42*****	6"W x 42"D x 42"H	R or S*	WR or DF**

CRAFTSMAN STYLE RUSTIC WOOD OUTLOOKERS



FUNSTON STYLE FSTO4



THORTON STYLE THRO4



WESTLAKE STYLE WTLO4



TRADITIONAL STYLE TRA04



Part Number	Size	Rough or Smooth	Wood Species
OUT08X14X14*****	8"W x 14"D x 14"H	R or S*	WR or DF**
OUT08X14X18*****	8"W x 14"D x 18"H	R or S*	WR or DF**
OUT08X14X22*****	8"W x 14"D x 22"H	R or S*	WR or DF**
OUT08X16X16*****	8"W x 16"D x 16"H	R or S*	WR or DF**
OUT08X16X20*****	8"W x 16"D x 20"H	R or S*	WR or DF**
OUT08X16X24*****	8"W x 16"D x 24"H	R or S*	WR or DF**
OUT08X16X28*****	6"W x 16"D x 28"H	R or S*	WR or DF**
OUT08X18X18*****	8"W x 18"D x 18"H	R or S*	WR or DF**
OUT08X18X22*****	8"W x 18"D x 22"H	R or S*	WR or DF**
OUT08X18X26*****	8"W x 18"D x 26"H	R or S*	WR or DF**
OUT08X18X30*****	8"W x 18"D x 30"H	R or S*	WR or DF**
OUT08X20X20*****	8"W x 20"D x 20"H	R or S*	WR or DF**
OUT08X20X24*****	8"W x 20"D x 24"H	R or S*	WR or DF**
OUT08X20X28*****	8"W x 20"D x 28"H	R or S*	WR or DF**
OUT08X20X32*****	8"W x 20"D x 34"H	R or S*	WR or DF**
OUT08X22X22*****	8"W x 22"D x 22"H	R or S*	WR or DF**
OUT08X22X26*****	8"W x 22"D x 26"H	R or S*	WR or DF**
OUT08X22X30*****	8"W x 22"D x 30"H	R or S*	WR or DF**
OUT08X24X24*****	8"W x 24"D x 24"H	R or S*	WR or DF**
OUT08X24X28*****	8"W x 24"D x 28"H	R or S*	WR or DF**
OUT08X24X32*****	8"W x 24"D x 32"H	R or S*	WR or DF**
OUT08X26X26*****	8"W x 26"D x 26"H	R or S*	WR or DF**
OUT08X26X30*****	8"W x 26"D x 30"H	R or S*	WR or DF**
OUT08X26X34*****	8"W x 26"D x 34"H	R or S*	WR or DF**
OUT08X28X28*****	8"W x 28"D x 28"H	R or S*	WR or DF**
OUT08X28X32*****	8"W x 28"D x 32"H	R or S*	WR or DF**
OUT08X28X40*****	8"W x 28"D x 40"H	R or S*	WR or DF**
OUT08X34X34*****	8"W x 34"D x 34"H	R or S*	WR or DF**
OUT08X34X42*****	8"W x 34"D x 42"H	R or S*	WR or DF**
OUT08X40X40*****	8"W x 40"D x 40"H	R or S*	WR or DF**

RUSTIC WOOD RAFTER TAILS



Part Number	Size	Rough or Smooth	Wood Species
RFT04X06X12	4"W x 6"H x 12"L	R or S	WR or DF
RFT04X08X12	4"W x 8"H x 12"L	R or S	WR or DF
RFT04X10X12	4"W x 10"H x 12"L	R or S	WR or DF
RFT04X12X12	4"W x 12"H x 12"L	R or S	WR or DF
RFT06X06X12	6"W x 6"H x 12"L	R or S	WR or DF
RFT06X08X12	6"W x 8"H x 12"L	R or S	WR or DF
RFT06X10X12	6"W x 10"H x 12"L	R or S	WR or DF
RFT06X12X12	6"W x 12"H x 12"L	R or S	WR or DF
RFT04X06X16	4"W x 6"H x 16"L	R or S	WR or DF
RFT04X08X16	4"W x 8"H x 16"L	R or S	WR or DF
RFT04X10X16	4"W x 10"H x 16"L	R or S	WR or DF
RFT04X12X16	4"W x 12"H x 16"L	R or S	WR or DF
RFT06X06X16	6"W x 6"H x 16"L	R or S	WR or DF
RFT06X08X16	6"W x 8"H x 16"L	R or S	WR or DF
RFT06X10X16	6"W x 10"H x 16"L	R or S	WR or DF
RFT06X12X16	6"W x 12"H x 16"L	R or S	WR or DF
RFT04X06X18	4"W x 6"H x 18"L	R or S	WR or DF
RFT04X08X18	4"W x 8"H x 18"L	R or S	WR or DF
RFT04X10X18	4"W x 10"H x 18"L	R or S	WR or DF
RFT04X12X18	4"W x 12"H x 18"L	R or S	WR or DF
RFT06X06X18	6"W x 6"H x 18"L	R or S	WR or DF
RFT06X08X18	6"W x 8"H x 18"L	R or S	WR or DF
RFT06X10X18	6"W x 10"H x 18"L	R or S	WR or DF
RFT06X12X18	6"W x 12"H x 18"L	R or S	WR or DF
RFT04X06X24	4"W x 6"H x 24"L	R or S	WR or DF
RFT04X08X24	4"W x 8"H x 24"L	R or S	WR or DF
RFT04X10X24	4"W x 10"H x 24"L	R or S	WR or DF
RFT04X12X24	4"W x 12"H x 24"L	R or S	WR or DF

RUSTIC WOOD RAFTER TAILS



PESCADERO STYLE PECOO



NEWPORT STYLE NEWOO



YORKTOWN STYLE YOROO



NEW BRIGHTON STYLE NEBOO



CRESTLINE STYLE CREOO



RIDGEWOOD STYLE RIDOO



Part Number	Size	Rough or Smooth	Wood Species
RFT06X06X24	6"W x 6"H x 24"L	R or S	WR or DF
RFT06X08X24	6"W x 8"H x 24"L	R or S	WR or DF
RFT06X10X24	6"W x 10"H x 24"L	R or S	WR or DF
RFT06X12X24	6"W x 12"H x 24"L	R or S	WR or DF
RFT04X06X32	4"W x 6"H x 32"L	R or S	WR or DF
RFT04X08X32	4"W x 8"H x 32"L	R or S	WR or DF
RFT04X10X32	4"W x 10"H x 32"L	R or S	WR or DF
RFT04X12X32	4"W x 12"H x 32"L	R or S	WR or DF
RFT06X06X32	6"W x 6"H x 32"L	R or S	WR or DF
RFT06X08X32	6"W x 8"H x 32"L	R or S	WR or DF
RFT06X10X32	6"W x 10"H x 32"L	R or S	WR or DF
RFT06X12X32	6"W x 12"H x 32"L	R or S	WR or DF
RFT04X06X36	4"W x 6"H x 36"L	R or S	WR or DF
RFT04X08X36	4"W x 8"H x 36"L	R or S	WR or DF
RFT04X10X36	4"W x 10"H x 36"L	R or S	WR or DF
RFT04X12X36	4"W x 12"H x 36"L	R or S	WR or DF
RFT06X06X36	6"W x 6"H x 36"L	R or S	WR or DF
RFT06X08X36	6"W x 8"H x 36"L	R or S	WR or DF
RFT06X10X36	6"W x 10"H x 36"L	R or S	WR or DF
RFT06X12X36	6"W x 12"H x 36"L	R or S	WR or DF
RFT04X06X48	4"W x 6"H x 48"L	R or S	WR or DF
RFT04X08X48	4"W x 8"H x 48"L	R or S	WR or DF
RFT04X10X48	4"W x 10"H x 48"L	R or S	WR or DF
RFT04X12X48	4"W x 12"H x 48"L	R or S	WR or DF
RFT06X06X48	6"W x 6"H x 48"L	R or S	WR or DF
RFT06X08X48	6"W x 8"H x 48"L	R or S	WR or DF
RFT06X10X48	6"W x 10"H x 48"L	R or S	WR or DF
RFT06X12X48	6"W x 12"H x 48"L	R or S	WR or DF

RUSTIC GABLE BRACKETS

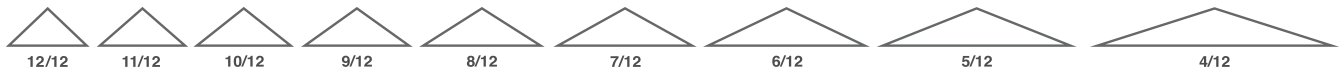
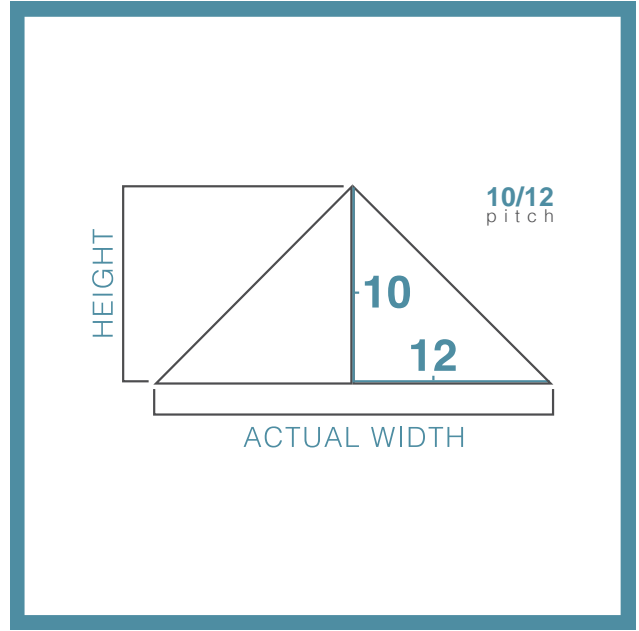

W	12/12	11/12	10/12	9/12	8/12	7/12	6/12	5/12	4/12
	HEIGHT								
36"	18"	16 1/2"	15"	13 1/2"	12"	10 1/2"	9"	7 1/2"	6"
48"	24"	22"	20"	18"	16"	14"	12"	10"	8"
60"	30"	27 1/2"	25"	22 1/2"	20"	17.5"	15"	12 1/2"	10"
72"	36"	33"	30"	27"	24"	21"	18"	15"	12"
84"	42"	38 1/2"	35"	31 1/2"	28"	24 1/2"	21"	17 1/2"	14"
96"	48"	44"	40"	36"	32"	28"	24"	20"	16"
108"	54"	49 1/2"	45"	40 1/2"	36"	31 1/2"	27"	22 1/2"	18"

GBW 24 X 072 X 04 06 POR 00 R DF

Product	Height	Width	Depth	Face	Style	Frame	Wood Cut	Wood
Gable Bracket Wood	24"	72"	4"	6"	Portland	No Frame	Rough	Douglas Fir

AVAILABLE ROUGH OR SMOOTH BEAM OPTIONS 4" OR 6"

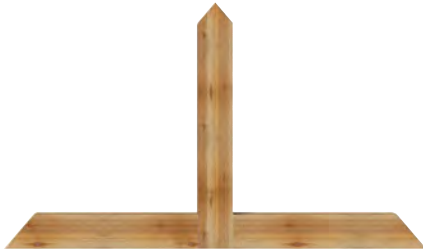

PORTLAND
GBWPOR

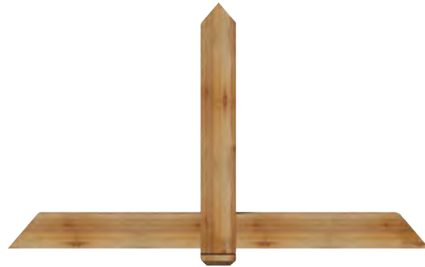

EUGENE
GBWEUG



BELLINGHAM
GBWBEL



SARATOGA
GBWSAR

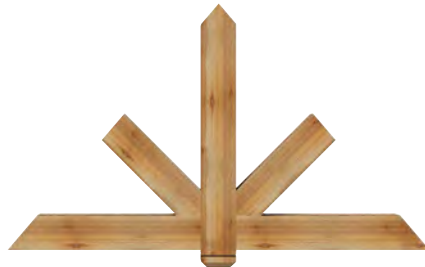

KENNEWICK
GBWKEN



REDMOND
GBWRED



RICHLAND
GBWRIC



ALBERTA
GBWALB



DAVENPORT
GBWDAV



SMOOTH
DOUGLAS FIR



ROUGH SAWN
DOUGLAS FIR



SMOOTH WESTERN
RED CEDAR

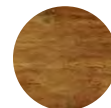

ROUGH SAWN
WESTERN RED CEDAR

WIDTH



HEIGHT



DEPTH

INTERIOR PRODUCTS

With a diverse line of interior products you are bound to find the perfect fit for your home or project. Each product is made from top of the line materials and will leave you satisfied with the end result. Call one of our product specialists to find out what will best suit your needs and start transforming your home today.



CROWN MOULDING SYSTEMS

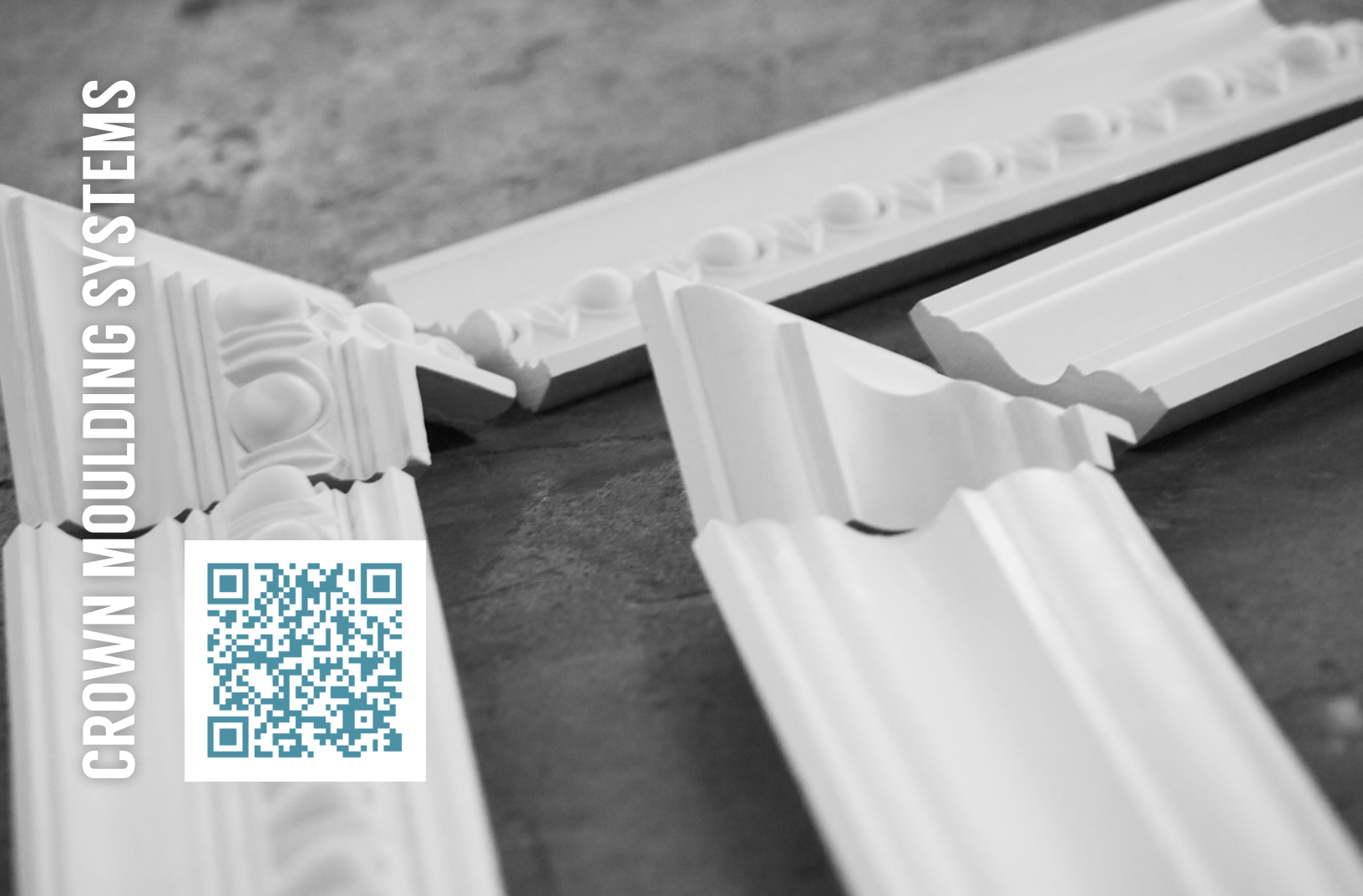

ANTONIO TRADITIONAL

Product ID	H	P	F	L
MLD04X09X10AN	4"	9"	10 1/4"	94 1/2"

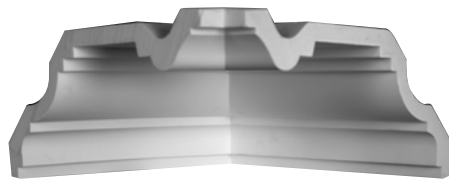

Product ID
MIC04X09AN



FOSTER

Product ID	H	P	F	L
MLD06X07X09FO	6 3/4"	7"	9 3/4"	94 1/2"

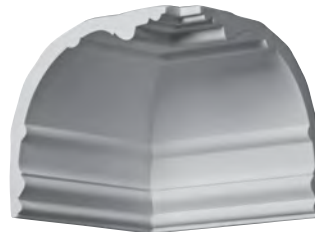

Product ID
MIC07X06FO



Product ID
MOC07X06FO

CROWN MOULDING SYSTEMS



Product ID

MIC07X05NI



Product ID

MOC07X05NI

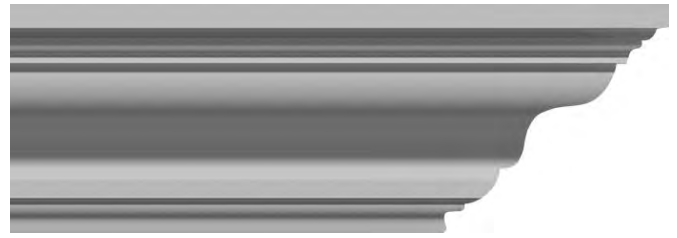

NIOBE

Product ID

MLD05X07X09NI

H

.

5"

P

.

7 1/2"

F

.

9 3/8"

L

.

94 1/2"

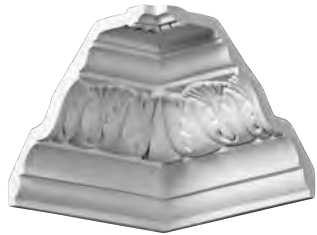

Product ID

MIC05X06TI



Product ID

MOC05X06TI



TIRANA

Product ID

MLD06X05X08TI

H

.

6 7/8"

P

.

5 1/8"

F

.

8 5/8"

L

.

94 1/2"

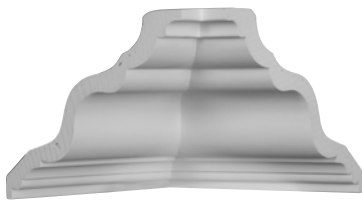

Product ID

MIC05X06VE



Product ID

MOC05X06VE

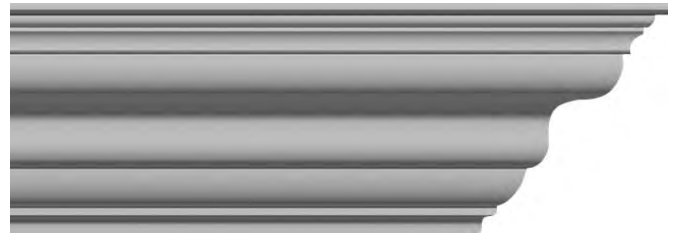

VERSAILLES SMOOTH

Product ID

MLD05X06X08VE

H

.

5 5/8"

P

.

6 3/8"

F

.

8 1/2"

L

.

94 1/2"



Product ID

MIC05X06MO



Product ID

MOC05X06MO



MONIQUE

Product ID

MLD05X06X08MO

H

.

5 1/4"

P

.

6 1/4"

F

.

8 1/4"

L

.

94 1/2"

HEIGHT

PROJECTION

FACE

LENGTH

CROWN MOULDING SYSTEMS

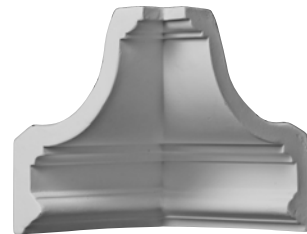

MARIA

Product ID	H	P	F	L
MLD03X04X05TR	6"	4 1/2"	7 3/4"	94 1/2"

Product ID
MIC04X03TR

Product ID
MOC04X03TR

keep it
SIMPLE.

keep it
MITERLESS.



ATTICA

Product ID	H	P	F	L
MLD05X05X07AT	5 1/4"	5 1/4"	7 1/2"	94 1/2"

Product ID
MIC05X05AT

Product ID
MOC05X05AT

CROWN MOULDING SYSTEMS

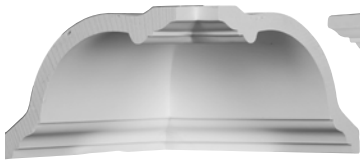

Product ID

MIC06X04DI



Product ID

MOC06X04DI



DIANE TRADITIONAL

Product ID	H	P	F	L
MLD06X04X07DI	4 1/8"	6 1/8"	7 1/4"	94 1/2"

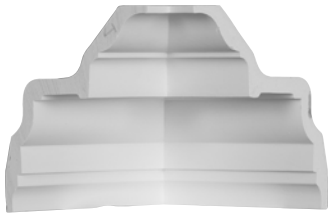

Product ID

MIC05X05FE



Product ID

MOC05X05FE



FELIX TRADITIONAL SMOOTH

Product ID	H	P	F	L
MLD05X05X07FE	5"	5"	7"	94 1/2"



Product ID

MIC02X05RO



Product ID

MOC02X05RO



ROSE

Product ID	H	P	F	L
MLD05X02X06RO	5 1/2"	3 3/4"	6 3/4"	94 1/2"

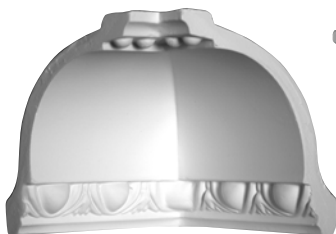

Product ID

MIC04X05AR



Product ID

MOC04X05AR



ARTIS EGG & DART

Product ID	H	P	F	L
MLD04X05X06AR	4 1/4"	5 1/4"	6 3/4"	94 1/2"

HEIGHT

PROJECTION

FACE

LENGTH

CROWN MOULDING SYSTEMS



STRASBOURG TRADITIONAL

Product ID	H	P	F	L
MLD04X04X06SG	4 7/8"	4 3/8"	6 1/2"	94 1/2"

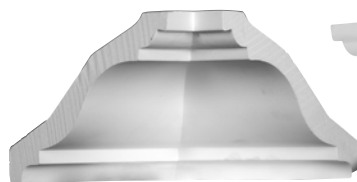

Product ID
MIC04X04SG



Product ID
MOC04X04SG



DENTIL

Product ID	H	P	F	L
MLD04X04X06DE	4 1/2"	4 1/2"	6 3/8"	94 5/8"



Product ID
MIC04X04DE



Product ID
MOC04X04DE



EDWARDS SMOOTH

Product ID	H	P	F	L
MLD04X05X06ED	4"	5"	6 3/8"	94 1/2"

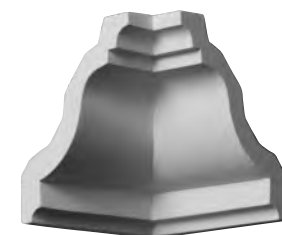

Product ID
MIC05X04ED



Product ID
MOC05X04ED



BRADFORD TRADITIONAL SMOOTH

Product ID	H	P	F	L
MLD04X04X06BR	4 1/4"	4 3/4"	6 3/8"	94 1/2"

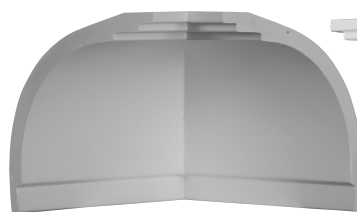

Product ID
MIC04X04BR



Product ID
MOC04X04BR

CROWN MOULDING SYSTEMS



Product ID

MIC05X02RI



Product ID

MOC05X02RI



RICHMOND

Product ID	H	P	F	L
MLD05X02X06RI	5 1/2"	2 1/4"	6"	94 1/2"



**WE MAKE WOOD
MOULDING TOO!**

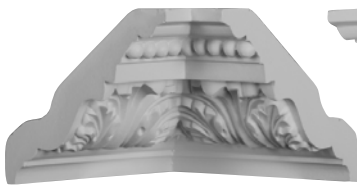

Product ID

MIC03X04PA



Product ID

MOC03X04PA



PALMETTO

Product ID	H	P	F	L
MLD03X04X06PA	3 3/4"	4 5/8"	6"	94 5/8"

HEIGHT

PROJECTION

FACE

LENGTH

CROWN MOULDING SYSTEMS

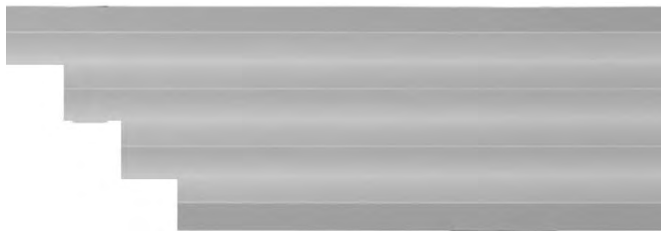

ERIS STEP

Product ID	H	P	F	L
MLD04X04X06ER	4 1/4"	4 1/4"	6"	96"

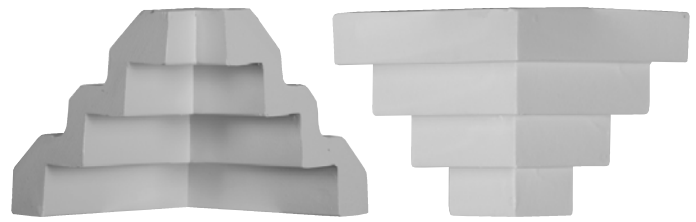

Product ID
MIC04X04ER

Product ID
MOC04X04ER



WAKEFIELD

Product ID	H	P	F	L
MLD04X05X06WA	4 3/4"	5 1/8"	6"	96"

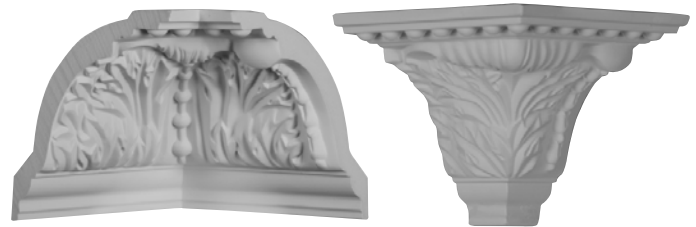

Product ID
MIC04X05WA

Product ID
MOC04X05WA

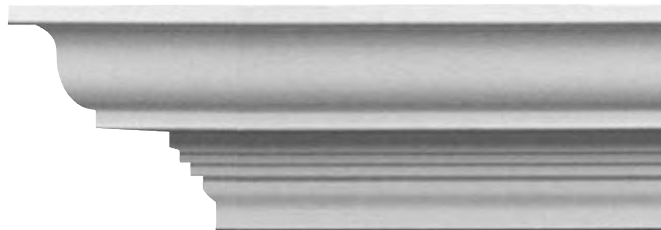

BULWARK

Product ID	H	P	F	L
MLD03X04X05BU	3 7/8"	4 1/2"	5 7/8"	94 1/2"



Product ID
MIC04X03BU

Product ID
MOC04X03BU



DEVON SMOOTH

Product ID	H	P	F	L
MLD03X04X05DE	3 3/8"	4 3/4"	5 7/8"	94 1/2"

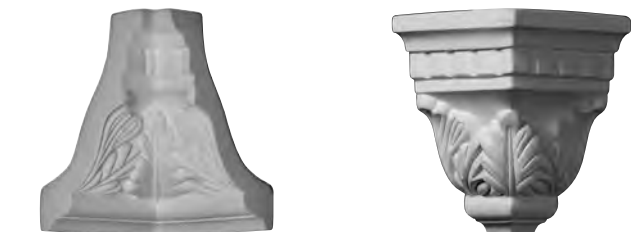

Product ID
MIC03X04DE

Product ID
MOC03X04DE

CROWN MOULDING SYSTEMS



Product ID

MIC04X03DY



Product ID

MOC04X03DY



DYLAN TRADITIONAL SMOOTH

Product ID	H	P	F	L
MLD03X04X05DY	3 3/4"	4 1/8"	5 5/8"	94 1/2"

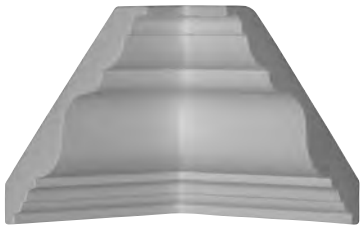

Product ID

MIC03X03DU



Product ID

MOC03X03DU



DUBLIN TRADITIONAL SMOOTH

Product ID	H	P	F	L
MLD03X03X05DU	3 7/8"	3 7/8"	5 1/2"	94 1/2"



Product ID

MIC03X03AT



Product ID

MOC03X03AT



ATTICA

Product ID	H	P	F	L
MLD03X03X05AT	3 7/8"	3 5/8"	5 3/8"	94 1/2"

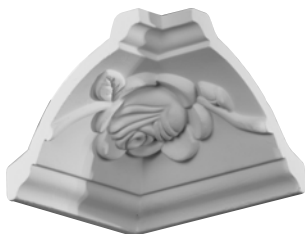

Product ID

MIC03X03BU



Product ID

MOC03X03BU



BULWARK

Product ID	H	P	F	L
MLD03X03X05BU	3 1/4"	3 3/4"	5"	94 5/8"

HEIGHT

PROJECTION

FACE

LENGTH

CROWN MOULDING SYSTEMS

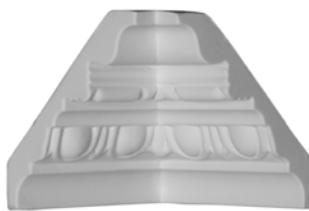

STOCKPORT

Product ID	H	P	F	L
MLD03X03X05ST	3 5/8"	3 3/8"	5"	94 5/8"

Product ID
MIC03X03ST

Product ID
MOC03X03ST



EDWARDS

Product ID	H	P	F	L
MLD04X02X05ED	4"	2 7/8"	5"	96"

Product ID
MIC03X04ED

Product ID
MOC03X04ED



CROWN MOULDING SYSTEMS



Product ID

MIC03X03HO



Product ID

MOC03X03HO



HOLMDEL

Product ID

MLD03X03X04HO

H

.

3 1/2"

P

.

3 3/8"

F

.

4 7/8"

L

.

94 1/2"

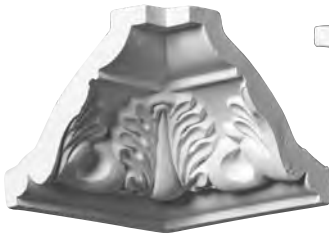

Product ID

MIC03X03LE



Product ID

MOC03X03LE



LEGACY

Product ID

MLD03X03X04LE

H

.

3 1/8"

P

.

3 1/2"

F

.

4 3/4"

L

.

94 5/8"



Product ID

MIC03X03DE



Product ID

MOC03X03DE

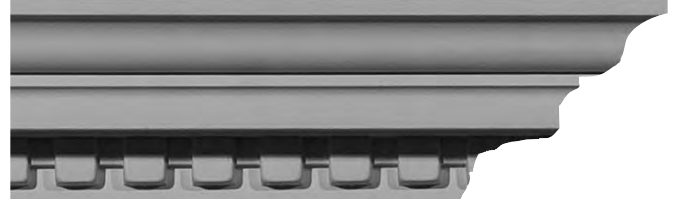

DEVON

Product ID

MLD03X03X04DE

H

.

3 3/8"

P

.

3 3/8"

F

.

4 3/4"

L

.

94 1/2"



Product ID

MIC03X03QU



Product ID

MOC03X03QU



QUEENSTOWN

Product ID

MLD03X03X04QU

H

.

3 1/2"

P

.

3 1/8"

F

.

4 3/4"

L

.

94 1/2"

HEIGHT

PROJECTION

FACE

LENGTH

CROWN MOULDING SYSTEMS



SALEM TRADITIONAL

Product ID	H	P	F	L
MLD03X03X04SA	3 1/4"	3 1/4"	4 1/2"	94 1/2"



Product ID
MIC03X03SA



Product ID
MOC03X03SA



HOLMDEL

Product ID	H	P	F	L
MLD04X02X04HO	4"	2 1/4"	4 1/2"	94 1/2"

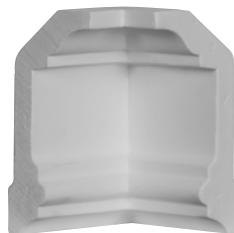

Product ID
MIC04X02HO



Product ID
MOC04X02HO



BEDFORD

Product ID	H	P	F	L
MLD03X03X04BE	3"	3 1/2"	4 3/8"	94 1/2"



Product ID
MIC03X03BE



Product ID
MOC03X03BE



EGG & DART

Product ID	H	P	F	L
MLD02X03X04EG	2 3/4"	3 1/8"	4 1/4"	94 1/2"



Product ID
MIC03X02EG



Product ID
MOC03X02EG

CROWN MOULDING SYSTEMS

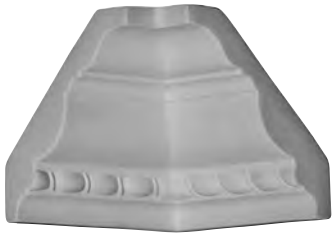

Product ID
MIC02X02CR



Product ID
MOC02X02CR



CRENDON

Product ID	H	P	F	L
MLD02X02X04CR	3"	3"	4 1/4"	94 1/2"

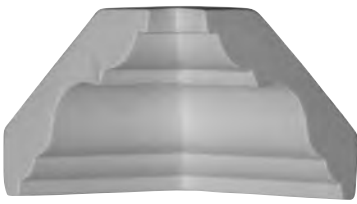

Product ID
MIC03X03PA



Product ID
MOC03X03PA

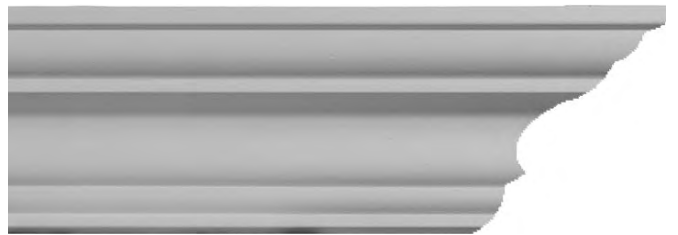

PALMETTO SMOOTH

Product ID	H	P	F	L
MLD03X03X04PA	3"	3"	4 1/4"	94 1/2"



HEIGHT

PROJECTION

FACE

LENGTH

CROWN MOULDING SYSTEMS

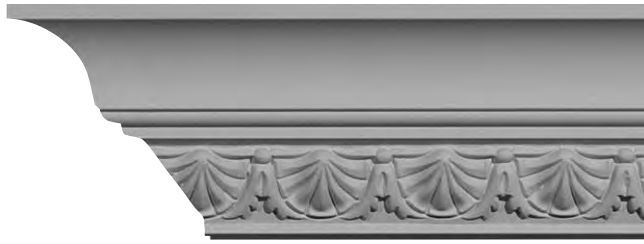

GORLEEN

Product ID	H	P	F	L
MLD03X02X04GO	3 1/8"	2 3/4"	4 1/8"	94 1/2"

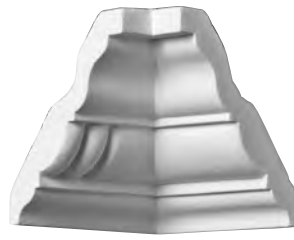

Product ID
MIC02X03GO



Product ID
MOC02X03GO



TRISTAN

Product ID	H	P	F	L
MLD02X02X04TN	2 3/4"	2 3/4"	4"	94 1/2"

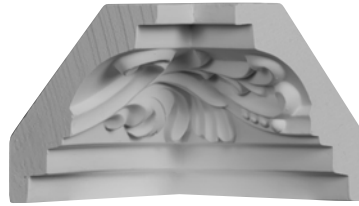

Product ID
MIC02X02TN



Product ID
MOC02X02TN



SHELL

Product ID	H	P	F	L
MLD02X02X02SH	2 7/8"	2 3/4"	4"	94 5/8"



Product ID
MIC02X02SH



Product ID
MOC02X02SH

SAME DETAIL.
EASIER INSTALLATION.

CROWN MOULDING SYSTEMS

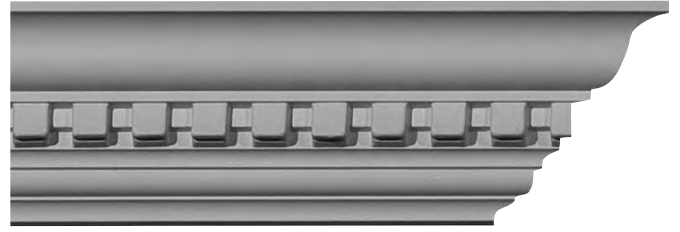
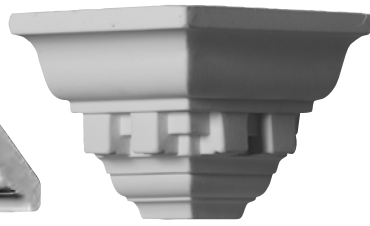
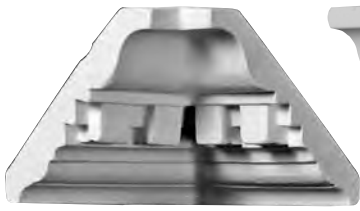

DENTIL

Product ID

MIC02X02DE

Product ID

MOC02X02DE

Product ID

MLD02X02X03DE

H
.

2 3/4"

P
.

2 3/4"

F
.

3 7/8"

L
.

94 5/8"

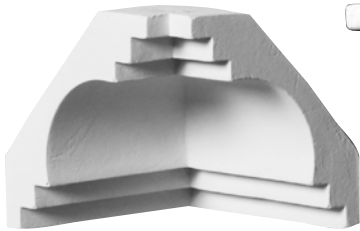

DUBLIN

Product ID

MIC02X02DU

Product ID

MOC02X02DU

Product ID

MLD02X02X03DU

H
.

2 3/4"

P
.

2 3/4"

F
.

3 7/8"

L
.

94 1/2"

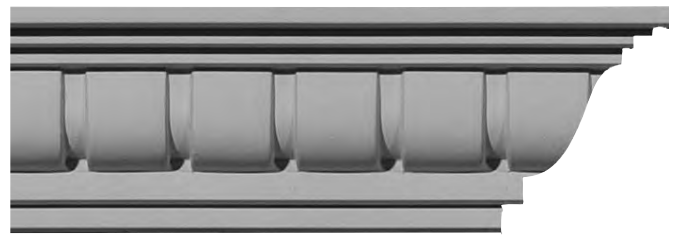
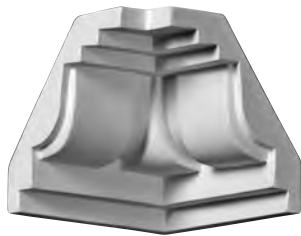

SEQUENTIAL

Product ID

MIC02X02SQ

Product ID

MOC02X02SQ

Product ID

MLD02X02X03SQ

H
.

2 5/8"

P
.

2 3/4"

F
.

3 3/4"

L
.

94 5/8"

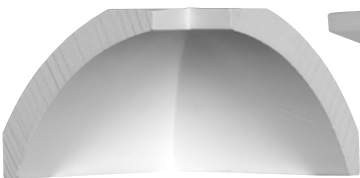

TRADITIONAL

Product ID

MIC02X02TR

Product ID

MOC02X02TR

Product ID

MLD02X02X03TR

H
.

2 3/8"

P
.

2 5/8"

F
.

3 5/8"

L
.

94 1/2"

HEIGHT

PROJECTION

FACE

LENGTH

CROWN MOULDING SYSTEMS



RAYNOR

Product ID	H	P	F	L
MLD03X01X03BE	3 1/8"	1 1/2"	3 1/2"	94 5/8"

Product ID
MIC01X03BE

Product ID
MOC01X03BE

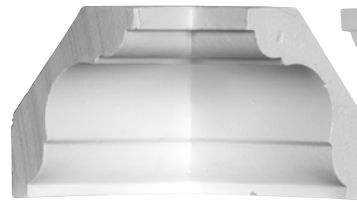

JEFFERSON TRADITIONAL SMOOTH

Product ID	H	P	F	L
MLD02X02X03JE	2 1/4"	2 1/4"	3 1/4"	94 1/2"

Product ID
MIC02X02JE

Product ID
MOC02X02JE

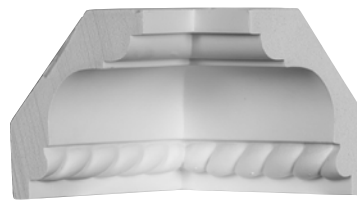

LEANDROS ROPE

Product ID	H	P	F	L
MLD02X02X06LN	2 1/4"	2 1/4"	3 1/8"	94 1/2"

Product ID
MIC02X02LN

Product ID
MOC02X02LN

MORE MOULDING ON PAGE 154.

CROWN MOULDING SYSTEMS

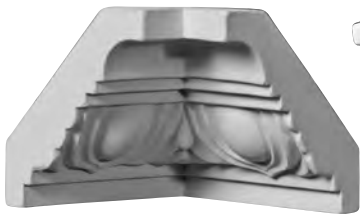

Product ID

MIC02X02EG

Product ID

MOC02X02EG



EGG & DART

Product ID

MLD02X02X03EG

H

.

3"

P

.

1 1/8"

F

.

3"

L

.

94 5/8"

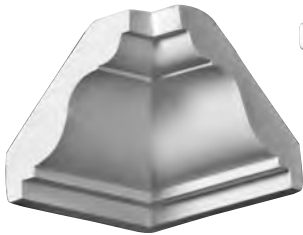

Product ID

MIC02X02LY

Product ID

MOC02X02LY



LYNON TRADITIONAL SMOOTH

Product ID

MLD02X02X03LY

H

.

2"

P

.

2"

F

.

3"

L

.

94 1/2"

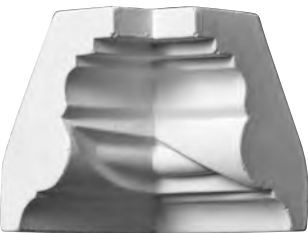

Product ID

MIC01X02VA

Product ID

MOC01X02VA



VALERIANO

Product ID

MLD02X01X02VA

H

.

2 1/8"

P

.

1 5/8"

F

.

2 5/8"

L

.

94 1/2"

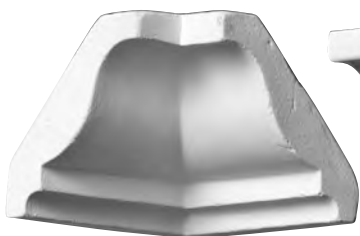

Product ID

MIC01X01OD

Product ID

MOC01X01OD



ODESSA

Product ID

MLD01X01X02OD

H

.

1 5/8"

P

.

1 5/8"

F

.

2 1/4"

L

.

94 1/2"

HEIGHT

PROJECTION

FACE

LENGTH

CROWN MOULDING



CROWN MOULDING



BRIGHTTON

Product ID	H	P	F	L
MLD18X16X24BR	18 1/4"	16 3/8"	23 7/8"	96"



MARCELLA

Product ID	H	P	F	L
MLD16X16X23MA	16 3/8"	16 1/2"	23 3/8"	96"



LARGE MILTON

Product ID	H	P	F	L
MLD10X12X16MI	10 5/8"	12 5/8"	16 1/8"	96"



HILLSBOROUGH ROCOCO

Product ID	H	P	F	L
MLD09X10X14HI	9 7/8"	10 5/8"	14 1/2"	96"



CLAREMONT SMOOTH

Product ID	H	P	F	L
MLD09X12X14CL	9"	11 3/4"	14 1/4"	96"



GRANADA

Product ID	H	P	F	L
MLD09X09X14GR	9 7/8"	9 3/4"	14"	96"



LARGE FASCIA

Product ID	H	P	F	L
MLD12X07X14FA	12 1/8"	7 1/8"	14"	96"



SPRINGTIME

Product ID	H	P	F	L
MLD11X08X13SP	11 3/8"	8 1/8"	13 7/8"	96"

CROWN MOULDING



CHESTERFIELD

Product ID	H	P	F	L
MLD11X04X12CH	11 7/8"	4"	12 5/8"	96"



ROSETTA

Product ID	H	P	F	L
MLD08X09X12RO	9"	9"	12 1/2"	94 1/2"



MEDWAY

Product ID	H	P	F	L
MLD08X08X12ME	8 1/2"	8 1/2"	12"	94 1/2"



ERIS SMOOTH

Product ID	H	P	F	L
MLD13X07X12ER	13"	6 7/8"	11 5/8"	96"



ACANTHUS LEAF WITH BEAD & BARREL

Product ID	H	P	F	L
MLD08X08X11AC	8 1/4"	8"	11 1/2"	96"



MEDEA BEADED

Product ID	H	P	F	L
MLD08X07X11MD	8 3/4"	7"	11 1/4"	94 1/2"



ODESSA

Product ID	H	P	F	L
MLD07X09X11OD	6 5/8"	9"	11 1/4"	96"



TRADITIONAL

Product ID	H	P	F	L
MLD08X08X11TR	7 3/4"	7 3/4"	11"	96 1/8"

CROWN MOULDING



FOSTER TRADITIONAL

Product ID	H	P	F	L
MLD08X06X10FO	8 1/4"	6 5/8"	10 5/8"	94 1/2"



AMELIA

Product ID	H	P	F	L
MLD08X06X10AM	8 1/4"	6 1/4"	10 3/8"	96 1/8"



FLORAL SWAG

Product ID	H	P	F	L
MLD06X08X10FL	6 3/8"	8"	10 3/8"	95 5/8"

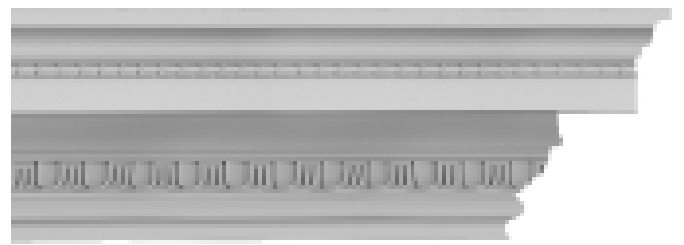

BEDFORD BEADED

Product ID	H	P	F	L
MLD07X07X10BE	7 3/8"	7 1/4"	10 1/4"	96"

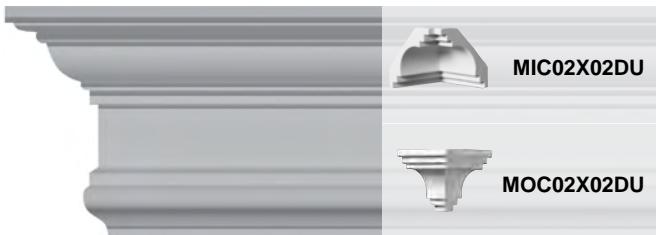

ANTONIO TRADITIONAL

Product ID	H	P	F	L
MLD04X09X10AN	4"	9"	10 1/4"	94 1/2"



WOODRUFF

Product ID	H	P	F	L
MLD09X03X09WF	9 1/8"	3 3/4"	9 7/8"	94 1/4"



SOUTHAMPTON ACANTHUS

Product ID	H	P	F	L
MLD09X03X09SO	9 1/8"	3 7/8"	9 7/8"	94 1/2"

OVER
300
MOULDINGS

CROWN MOULDING



DENTIL

Product ID	H	P	F	L	
MLD06X08X10DE	6 3/8"	7 3/4"	9 7/8"	96 1/8"	



ALEXANDRIA

Product ID	H	P	F	L	
MLD09X03X10AL	9 1/4"	3 3/4"	9 7/8"	96"	

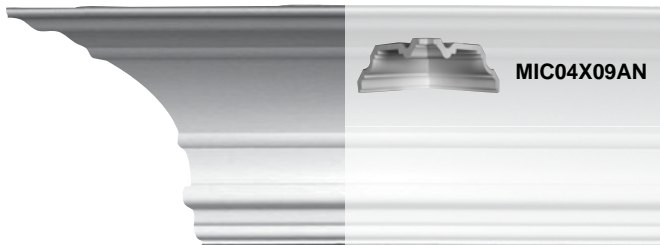

FOSTER

Product ID	H	P	F	L	
MLD06X07X09FO	6 3/4"	7"	9 3/4"	94 1/2"	



ARTIS

Product ID	H	P	F	L	
MLD07X06X09AR	7 3/8"	6 1/8"	9 5/8"	96"	



ODESSA

Product ID	H	P	F	L	
MLD07X05X09OD	7 3/4"	5 1/2"	9 1/2"	96"	



NIOBE

Product ID	H	P	F	L	
MLD05X07X09NI	5"	7 1/2"	9 3/8"	94 1/2"	



STOCKPORT

Product ID	H	P	F	L	
MLD06X06X09ST	6 1/2"	6 1/2"	9 1/4"	94 1/2"	



BEDFORD

Product ID	H	P	F	L	
MLD08X03X09BE	8 3/8"	3 3/4"	9"	96"	

CROWN MOULDING



HAMPTON

Product ID	H	P	F	L
MLD06X06X09HM	6 1/4"	6 1/4"	8 7/8"	94 1/2"



FASCIA

Product ID	H	P	F	L
MLD06X05X08FA	6 7/8"	5 1/2"	8 7/8"	96"



SYDNEY

Product ID	H	P	F	L
MLD06X06X08SY	6 1/4"	6 1/4"	8 7/8"	94 1/2"



JONEE BARSOM

Product ID	H	P	F	L
MLD07X06X09JO	6 5/8"	5 1/2"	8 5/8"	94 1/2"



TIRANA

Product ID	H	P	F	L
MLD06X05X08TI	6 7/8"	5 1/8"	8 5/8"	94 1/2"



CARRILLO

Product ID	H	P	F	L
MLD06X06X09CI	6 1/2"	6"	8 5/8"	96"



CLAREMONT TRADITIONAL SMOOTH

Product ID	H	P	F	L
MLD06X05X08CL	6 1/2"	5 3/4"	8 5/8"	94 1/2"



ZEPHYR WITH EGG & DART

Product ID	H	P	F	L
MLD07X05X08ZE	7"	5"	8 5/8"	96"

CROWN MOULDING



PIEDMONT

Product ID	H	P	F	L	
MLD04X07X08PE	4 1/2"	7 1/4"	8 1/2"	94 1/2"	



VERSAILLES SMOOTH

Product ID	H	P	F	L	
MLD05X06X08VE	5 5/8"	6 3/8"	8 1/2"	94 1/2"	



LARGE BRIGHTTON

Product ID	H	P	F	L	
MLD06X06X08BR	6"	6"	8 3/8"	94 1/2"	



BERKSHIRE

Product ID	H	P	F	L	
MLD06X05X08BE	6 1/2"	5"	8 1/4"	94 1/2"	



MONIQUE

Product ID	H	P	F	L	
MLD05X06X08MO	5 1/4"	6 1/4"	8 1/4"	94 1/2"	



FLOWER DROP

Product ID	H	P	F	L	
MLD07X03X08FL	7 1/2"	3 1/8"	8 1/8"	94 1/2"	



ALEXA

Product ID	H	P	F	L	
MLD06X04X07AX	6 1/4"	4 3/4"	7 7/8"	96"	



MILTON SMOOTH

Product ID	H	P	F	L	
MLD07X03X08MI	7 1/8"	3 1/4"	7 3/4"	94 1/2"	

CROWN MOULDING



FLOWER

Product ID	H	P	F	L	
MLD05X05X07FL	5 3/8"	5 1/2"	7 3/4"	94 5/8"	

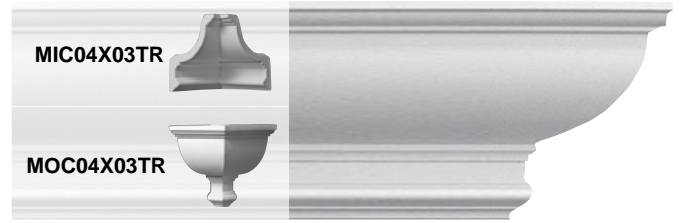

MARIA TRADITIONAL

Product ID	H	P	F	L	
MLD03X04X05TR	6"	4 1/2"	7 3/4"	94 1/2"	



ARTIS

Product ID	H	P	F	L	
MLD05X05X07AR	5 5/8"	5 1/4"	7 5/8"	96"	



NESTOR

Product ID	H	P	F	L	
MLD05X04X07NS	5 7/8"	4 3/4"	7 1/2"	94 1/2"	

HEIGHT

PROJECTION

FACE

LENGTH

CROWN MOULDING



ATTICA

Product ID	H	P	F	L	
MLD05X05X07AT	5 1/4"	5 1/4"	7 1/2"	94 1/2"	



FEDERAL

Product ID	H	P	F	L	
MLD05X04X07FE	5 3/4"	4 3/4"	7 1/2"	94 1/2"	



TERRONES

Product ID	H	P	F	L	
MLD05X05X07TS	5"	5 3/8"	7 3/8"	94 1/2"	



LARGE ELEGANT HAMPSHIRE

Product ID	H	P	F	L	
MLD06X04X07HA	6"	4 1/8"	7 1/4"	94 1/2"	

CROWN MOULDING



GENEVIEVE

Product ID	H	P	F	L	
MLD06X02X07GE	7"	3"	7 1/4"	96"	



VALLETTA

Product ID	H	P	F	L	
MLD07X02X07VL	7"	2 1/4"	7 1/4"	94 1/2"	

CHECK OUT OUR WOOD MOULDING ON PAGE 430

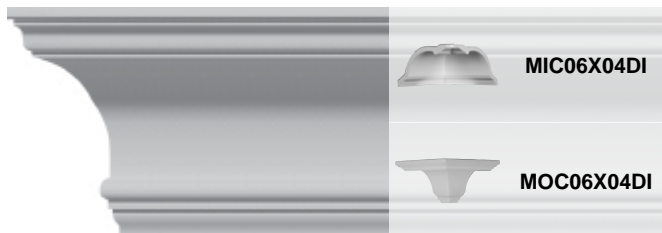

DIANE TRADITIONAL

Product ID	H	P	F	L	
MLD06X04X07DI	4 1/8"	6 1/8"	7 1/4"	94 1/2"	



WAKEFIELD

Product ID	H	P	F	L	
MLD05X05X07WA	5"	5"	7 1/8"	94 1/2"	



DENTIL

Product ID	H	P	F	L	
MLD05X05X07DE	5"	5"	7 1/8"	94 1/2"	

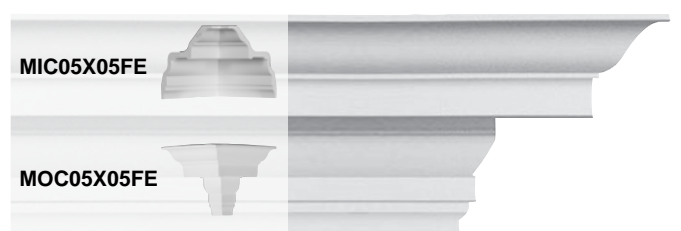

FELIX TRADITIONAL SMOOTH

Product ID	H	P	F	L	
MLD05X05X07FE	5"	5"	7"	94 1/2"	

CROWN MOULDING

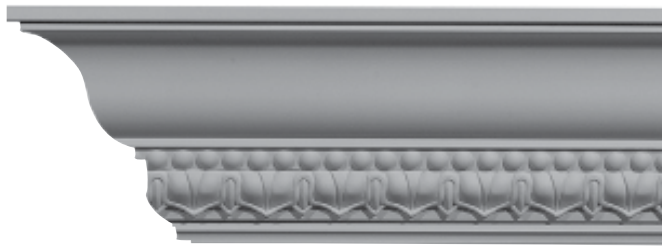

NADIA

Product ID	H	P	F	L
MLD04X05X07NA	4 3/4"	5 1/8"	7"	94 5/8"



HEATON

Product ID	H	P	F	L
MLD05X05X07HE	5 1/8"	4 3/4"	7"	94 1/2"



FLORAL

Product ID	H	P	F	L
MLD06X02X07FL	6 1/4"	2 3/4"	7"	96"



KIRKE

Product ID	H	P	F	L
MLD06X02X07KI	6 3/8"	2 1/2"	7"	94 5/8"

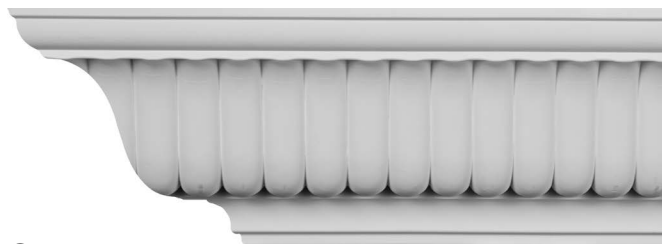

CARRILLO

Product ID	H	P	F	L
MLD04X05X07CI	4 5/8"	5 3/8"	6 7/8"	96"



FEDERAL

Product ID	H	P	F	L
MLD05X04X06SA	5 1/8"	4 1/4"	6 3/4"	94 1/2"

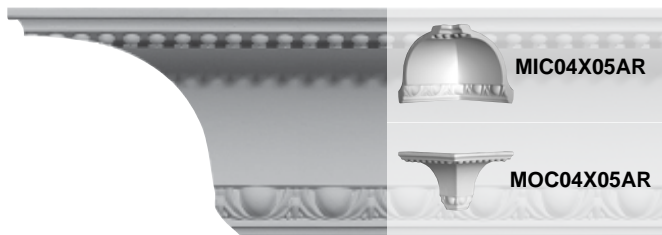

ARTIS EGG & DART

Product ID	H	P	F	L
MLD04X05X06AR	4 1/4"	5 1/4"	6 3/4"	94 1/2"



ROSE

Product ID	H	P	F	L
MLD05X02X06RO	5 1/2"	3 3/4"	6 3/4"	94 1/2"

CROWN MOULDING



BLACKTHORN

Product ID	H	P	F	L
MLD05X04X07BL	5 3/8"	4"	6 3/4"	96 1/8"



TRADITIONAL SMOOTH

Product ID	H	P	F	L
MLD05X03X06TR	5 1/2"	3 7/8"	6 3/4"	96"

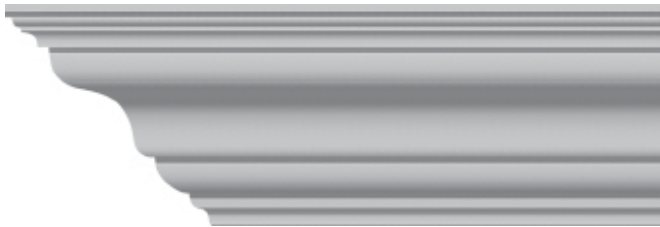

TRISTAN

Product ID	H	P	F	L
MLD04X04X06TN	4 3/4"	4 3/4"	6 3/4"	94 1/2"



FEDERAL

Product ID	H	P	F	L
MLD05X06X06FE	5 1/4"	4"	6 5/8"	94 1/2"



EGG & DART

Product ID	H	P	F	L
MLD06X03X07EG	6"	3 1/8"	6 5/8"	94 1/2"



COLE

Product ID	H	P	F	L
MLD04X05X07CO	4 1/8"	5"	6 1/2"	94 1/2"

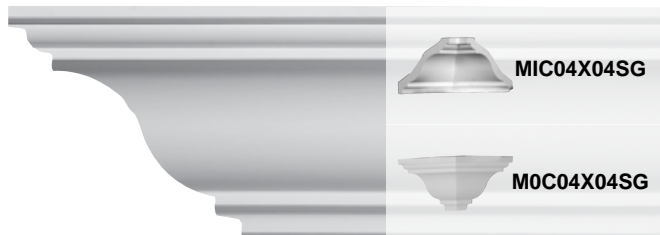

STRASBOURG TRADITIONAL

Product ID	H	P	F	L
MLD04X04X06SG	4 7/8"	4 3/8"	6 1/2"	94 1/2"



BRIGHTTON

Product ID	H	P	F	L
MLD05X05X06BR	4 5/8"	4 5/8"	6 1/2"	94 1/2"

CROWN MOULDING



SCOTT

Product ID	H	P	F	L
MLD05X03X06SC	5"	3 7/8"	6 1/2"	94 3/8"



JONEE

Product ID	H	P	F	L
MLD04X04X06JO	4 7/8"	4 1/4"	6 1/2"	95 5/8"

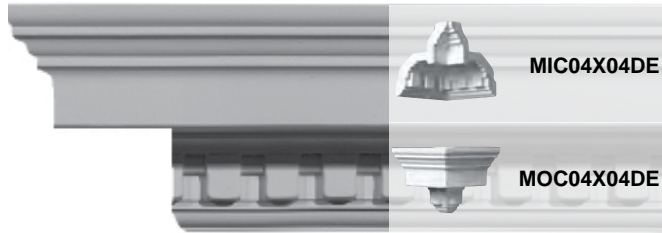

DENTIL

Product ID	H	P	F	L
MLD04X04X06DE	4 1/2"	4 1/2"	6 3/8"	94 5/8"



LOERA WITH ROPE

Product ID	H	P	F	L
MLD06X03X06LO	5 7/8"	2 5/8"	6 3/8"	96"



KENT

Product ID	H	P	F	L
MLD05X02X06KE	5 7/8"	2 1/2"	6 3/8"	94 5/8"



EMERY

Product ID	H	P	F	L
MLD04X04X06EM	4 1/2"	4 5/8"	6 3/8"	94 5/8"



EDWARDS SMOOTH

Product ID	H	P	F	L
MLD04X05X06ED	4"	5"	6 3/8"	94 1/2"



BRADFORD TRADITIONAL SMOOTH

Product ID	H	P	F	L
MLD04X04X06BR	4 1/4"	4 3/4"	6 3/8"	94 1/2"



HELENE LEAF

Product ID	H	P	F	L
MLD04X04X06HE	4 5/8"	4 1/8"	6 1/4"	94 5/8"

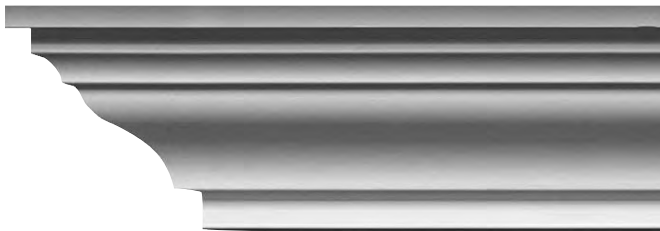

CLASSIC SMOOTH

Product ID	H	P	F	L
MLD04X04X06CL	4"	4 5/8"	6 1/8"	94 1/2"



CHARLOTTE

Product ID	H	P	F	L
MLD04X04X06CT	4 1/4"	4 1/4"	6 1/8"	94 1/2"



FLORAL

Product ID	H	P	F	L
MLD05X02X06FL	5 5/8"	2 1/4"	6"	94 1/2"

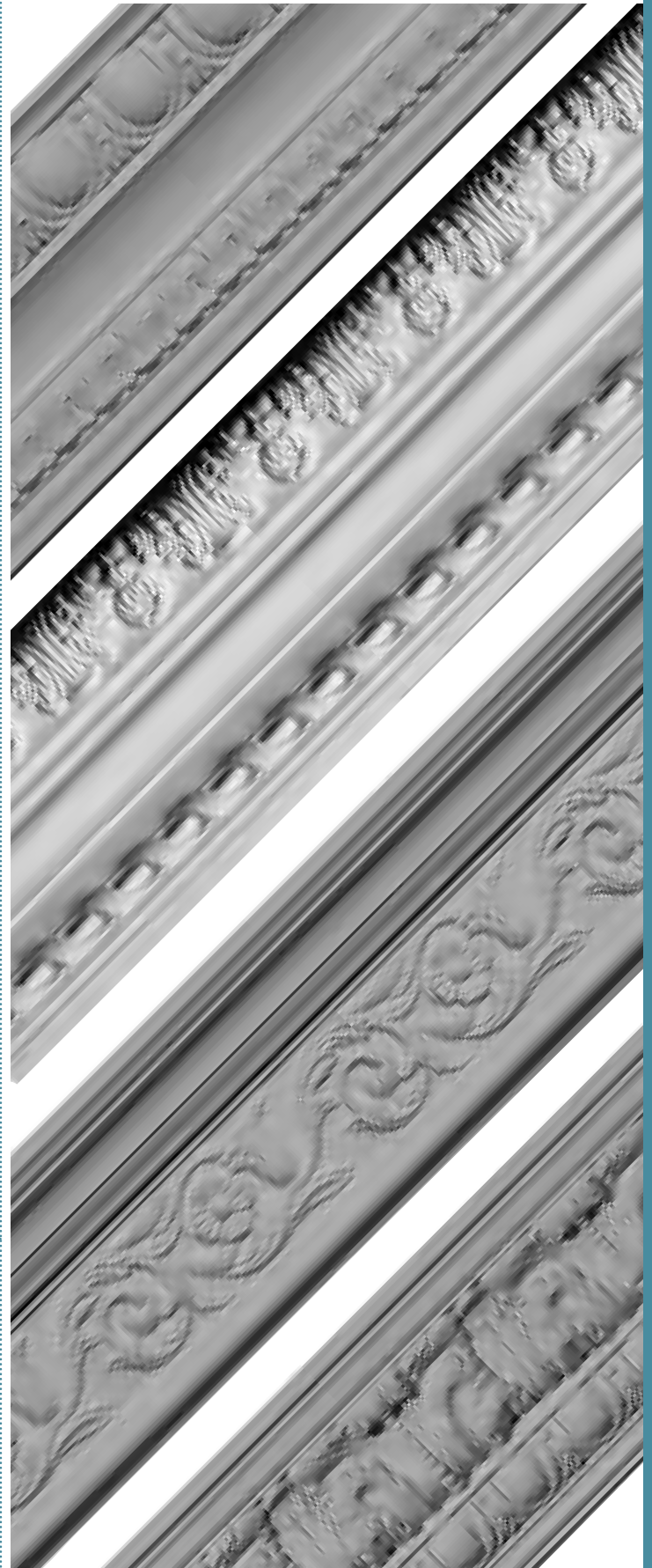

CROWN MOULDING



BEDFORD

Product ID	H	P	F	L
MLD04X03X06BE	4 7/8"	3 1/2"	6"	94 5/8"



COLTON EGG & DART ACANTHUS

Product ID	H	P	F	L
MLD04X03X06CO	4 1/2"	3 7/8"	6"	94 5/8"

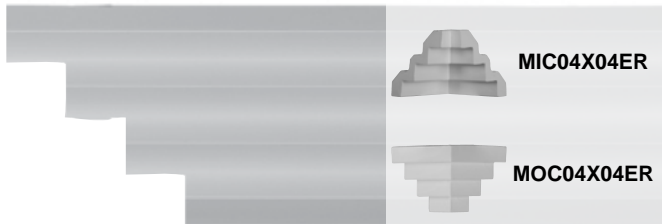

ERIS STEP

Product ID	H	P	F	L
MLD04X04X06ER	4 1/4"	4 1/4"	6"	96"



DUBLIN

Product ID	H	P	F	L
MLD04X03X06DU	4 1/2"	3 3/4"	6"	94 5/8"



PALMETTO

Product ID	H	P	F	L
MLD03X04X06PA	3 3/4"	4 5/8"	6"	94 5/8"



SPRINGTIME

Product ID	H	P	F	L
MLD05X02X06SP	5 1/8"	2 7/8"	6"	94 5/8"



NIOBE TRADITIONAL

Product ID	H	P	F	L
MLD05X03X06NI	5 1/8"	3 1/8"	6"	94 1/2"



WAKEFIELD

Product ID	H	P	F	L
MLD04X05X06WA	4 3/4"	5 1/8"	6"	96"

CROWN MOULDING



BEDFORD

Product ID	H	P	F	L
MLD05X02X06BE	5 5/8"	2 1/4"	6"	96"



RICHMOND

Product ID	H	P	F	L
MLD05X02X06RI	5 1/2"	2 1/4"	6"	94 1/2"



HAMPSHIRE TRADITIONAL

Product ID	H	P	F	L
MLD05X03X05HA	5"	3"	5 7/8"	94 5/8"

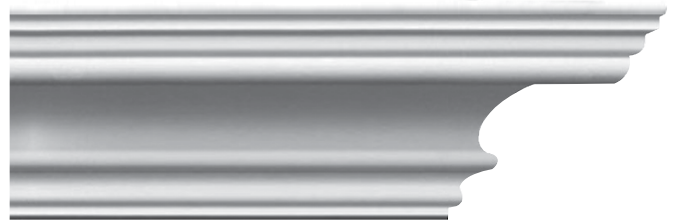

DEVON SMOOTH

Product ID	H	P	F	L
MLD03X04X05DE	3 3/8"	4 3/4"	5 7/8"	94 1/2"

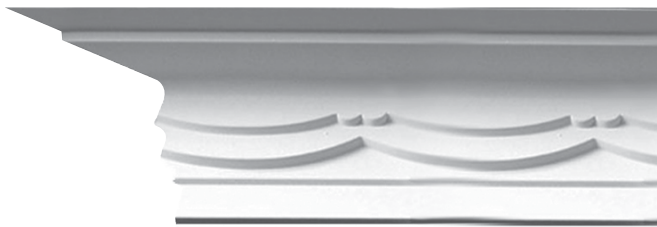

BATEMAN SWAG

Product ID	H	P	F	L
MLD04X04X05BA	4 1/8"	4 1/4"	5 7/8"	94 1/2"

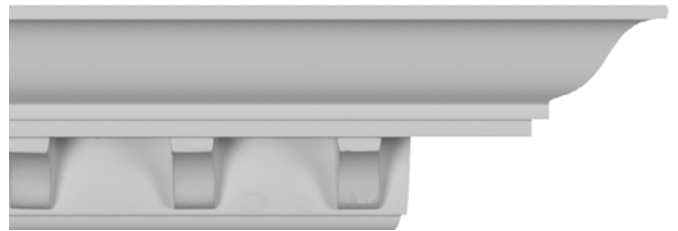

DENTIL

Product ID	H	P	F	L
MLD03X04X06DE	3 3/4"	4 1/2"	5 7/8"	96 1/8"



NOUVEAU

Product ID	H	P	F	L
MLD04X03X06NO	4 1/2"	3 3/4"	5 7/8"	96 1/8"

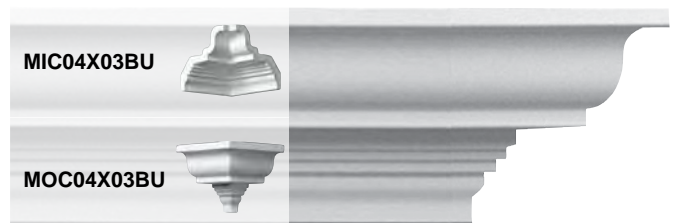

BULWARK

Product ID	H	P	F	L
MLD03X04X05BU	3 7/8"	4 1/2"	5 7/8"	94 1/2"

CROWN MOULDING



DUBLIN

Product ID	H	P	F	L
MLD04X04X04DU	4 1/8"	4 1/4"	5 7/8"	95 7/8"



ARTIS WITH SHELLS

Product ID	H	P	F	L
MLD05X03X06AR	5 1/8"	2 3/4"	5 3/4"	96"



HAMPSHIRE

Product ID	H	P	F	L
MLD05X04X06HA	4 1/4"	3 1/2"	5 3/4"	94 1/2"



EL SINORE TRADITIONAL SMOOTH

Product ID	H	P	F	L
MLD04X03X05EL	4 5/8"	3 1/2"	5 3/4"	94 1/2"



BULWARK

Product ID	H	P	F	L
MLD04X04X06BU	4 1/4"	3 7/8"	5 3/4"	95 3/8"



DYLAN TRADITIONAL SMOOTH

Product ID	H	P	F	L
MLD03X04X05DY	3 3/4"	4 1/8"	5 5/8"	94 1/2"

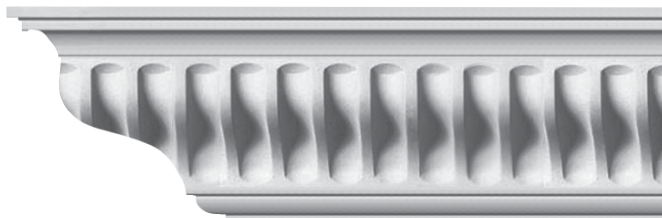

LINUS

Product ID	H	P	F	L
MLD04X04X06LI	4"	4"	5 5/8"	96"



FOSTER

Product ID	H	P	F	L
MLD02X05X05FO	2 1/8"	5 3/8"	5 5/8"	94 1/2"

CROWN MOULDING

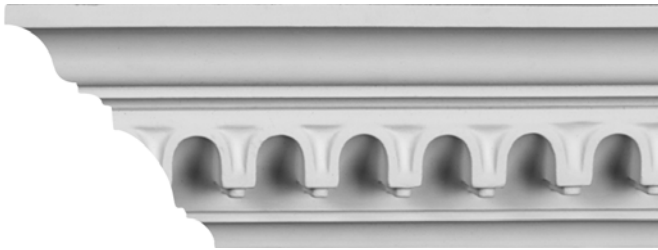

HEATON

Product ID	H	P	F	L
MLD03X04X06HE	3 7/8"	4"	5 5/8"	95 5/8"



DENTIL

Product ID	H	P	F	L
MLD04X03X06DE	4 3/8"	3 1/2"	5 5/8"	94 1/2"



CARRILLO

Product ID	H	P	F	L
MLD04X04X05CI	3 7/8"	3 7/8"	5 1/2"	96"



GRAPE BUNCH

Product ID	H	P	F	L
MLD04X04X05GR	3 7/8"	3 7/8"	5 1/2"	96"



VERSAILLES

Product ID	H	P	F	L
MLD05X02X05VE	4 7/8"	2 1/2"	5 1/2"	96"



KENDALL

Product ID	H	P	F	L
MLD04X04X06KD	4 1/8"	3 5/8"	5 1/2"	94 1/2"



DENTIL

Product ID	H	P	F	L
MLD05X03X05DE	4 5/8"	2 7/8"	5 1/2"	96"



DEVON

Product ID	H	P	F	L
MLD04X03X05DE	4 1/2"	3 1/4"	5 1/2"	94 1/2"

CROWN MOULDING



WINDSOR ROPE

Product ID	H	P	F	L
MLD03X04X05WI	3 3/4"	3 7/8"	5 1/2"	94 5/8"



MARCELLA

Product ID	H	P	F	L
MLD03X04X05MA	3 3/4"	4 1/8"	5 1/2"	96"



ASA ACANTHUS LEAF

Product ID	H	P	F	L
MLD04X02X05AS	5"	2 1/2"	5 1/2"	94 1/2"

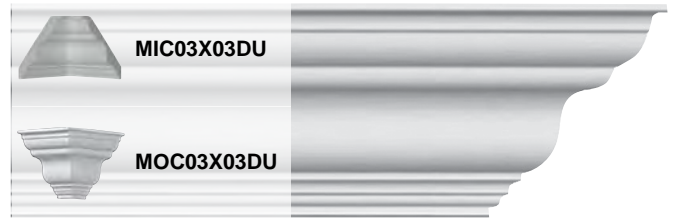

DUBLIN TRADITIONAL SMOOTH

Product ID	H	P	F	L
MLD03X03X05DU	3 7/8"	3 7/8"	5 1/2"	94 1/2"



GORLEEN

Product ID	H	P	F	L
MLD03X03X05GO	3 7/8"	3 7/8"	5 1/2"	94 1/2"



KEPLER

Product ID	H	P	F	L
MLD04X04X05KP	4"	3 7/8"	5 1/2"	96"

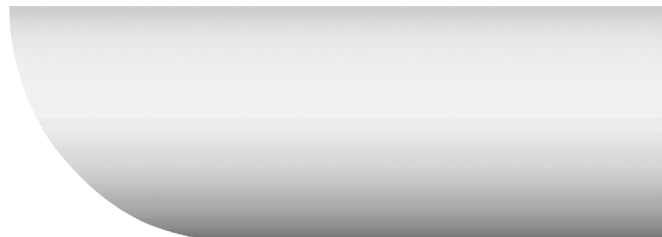

COVE

Product ID	H	P	F	L
MLD04X04X05CO	3 7/8"	3 7/8"	5 1/2"	96 1/8"



FOSTER TRADITIONAL SMOOTH

Product ID	H	P	F	L
MLD03X03X05FO	3 7/8"	3 7/8"	5 1/2"	94 1/2"

CROWN MOULDING



EMERY

Product ID	H	P	F	L
MLD04X04X05EM	3 7/8"	3 7/8"	5 1/2"	95 3/8"



ROSE

Product ID	H	P	F	L
MLD04X04X05RO	3 7/8"	3 7/8"	5 1/2"	96"



KENT

Product ID	H	P	F	L
MLD04X04X05KE	4"	3 1/2"	5 3/8"	94 1/2"



VICEROY

Product ID	H	P	F	L
MLD04X03X05VI	4 1/2"	3"	5 3/8"	94 1/2"



NADIA

Product ID	H	P	F	L
MLD05X03X05NA	4 3/4"	2 3/4"	5 3/8"	96"



EGG & DART

Product ID	H	P	F	L
MLD04X04X05EG	3 3/4"	4"	5 3/8"	94 1/2"



ATTICA

Product ID	H	P	F	L
MLD03X03X05AT	3 7/8"	3 5/8"	5 3/8"	94 1/2"



LISBON

Product ID	H	P	F	L
MLD03X03X05LI	3 1/2"	3 7/8"	5 1/4"	94 1/2"

CROWN MOULDING



BAROQUE

Product ID	H	P	F	L
MLD04X04X05BQ	3 3/4"	3 3/4"	5 1/4"	94 1/2"



STRASBOURG

Product ID	H	P	F	L
MLD03X03X05SG	3 5/8"	3 5/8"	5 1/4"	94 5/8"

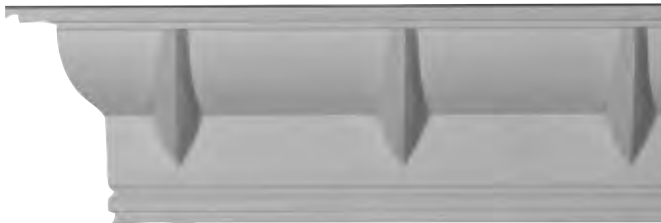

DECO

Product ID	H	P	F	L
MLD05X02X05DC	4 3/4"	2 3/8"	5 1/4"	94 1/2"



ANISE

Product ID	H	P	F	L
MLD05X02X05AN	4 3/4"	2 3/8"	5 1/4"	94 1/2"

WE HAVE
FLEX
MOULDING



HEATON

Product ID	H	P	F	L
MLD04X03X05HE	4 3/8"	2 7/8"	5 1/4"	96"



ERIS DENTIL

Product ID	H	P	F	L
MLD04X04X05ER	4 1/4"	4 1/8"	5 1/4"	94 1/2"

CROWN MOULDING



EGG & DART

Product ID	H	P	F	L
MLD04X02X05EG	4 3/4"	2 3/8"	5 1/4"	96"



GRANADA

Product ID	H	P	F	L
MLD04X03X05GR	3 3/4"	3 1/2"	5 1/8"	94 1/2"



NADIA

Product ID	H	P	F	L
MLD03X04X05NA	3"	4"	5 1/8"	96 1/8"

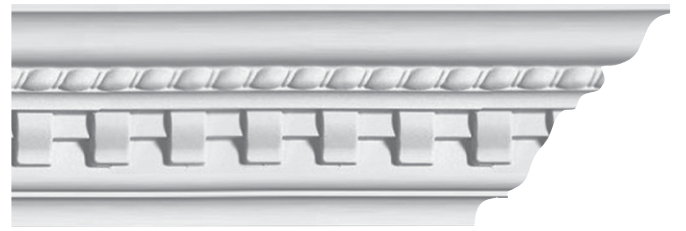

BULWARK DENTIL & ROPE

Product ID	H	P	F	L
MLD04X04X05BU	3 1/2"	3 7/8"	5 1/8"	95 5/8"



VERSAILLES

Product ID	H	P	F	L
MLD04X02X05VE	4 1/2"	2 3/8"	5 1/8"	94 5/8"



EMERY

Product ID	H	P	F	L
MLD04X03X05EM	4 1/2"	2 5/8"	5 1/8"	96"



THEIA BEAD & BARREL

Product ID	H	P	F	L
MLD03X03X05TH	3 3/4"	3 3/8"	5"	96"



NOUVEAU

Product ID	H	P	F	L
MLD03X03X05NO	3 1/2"	3 1/2"	5"	94 1/2"

CROWN MOULDING



MELCHOR

Product ID	H	P	F	L	
MLD04X02X05ML	4 3/8"	2 3/8"	5"	94 5/8"	



BULWARK

Product ID	H	P	F	L	
MLD03X03X05BU	3 1/4"	3 3/4"	5"	94 5/8"	



SUSSEX

Product ID	H	P	F	L	
MLD03X03X05SU	3 1/2"	3 1/2"	5"	96"	



TELMA

Product ID	H	P	F	L	
MLD04X02X05TE	4 1/2"	2"	5"	94 5/8"	

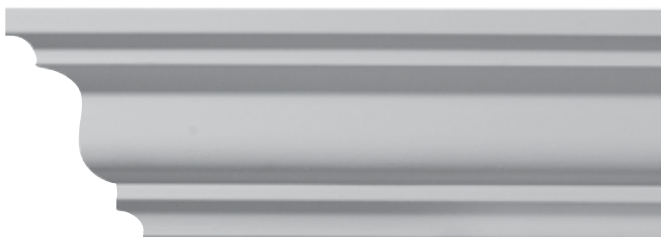

NEXUS

Product ID	H	P	F	L	
MLD04X03X05NE	4"	3"	5"	94 1/2"	



ASHFORD

Product ID	H	P	F	L	
MLD03X03X06AS	3 1/8"	3 1/8"	5"	96"	



TRADITIONAL SMOOTH

Product ID	H	P	F	L	
MLD04X03X05TR	4"	3"	5"	94 1/2"	



STOCKPORT

Product ID	H	P	F	L	
MLD03X03X05ST	3 5/8"	3 3/8"	5"	94 5/8"	

CROWN MOULDING



EDWARDS

Product ID	H	P	F	L
MLD04X02X05ED	4"	2 7/8"	5"	96"



JACKSON

Product ID	H	P	F	L
MLD04X03X05JA	3 5/8"	3 1/4"	5"	94 1/2"

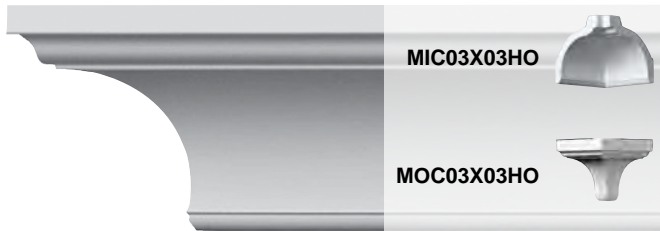

HOLMDEL

Product ID	H	P	F	L
MLD03X03X04HO	3 1/2"	3 3/8"	4 7/8"	94 1/2"



ROBIN

Product ID	H	P	F	L
MLD04X02X04RB	4 1/8"	2 3/8"	4 7/8"	94 1/2"



LISBON

Product ID	H	P	F	L
MLD03X04X05LI	3 3/8"	3 1/2"	4 7/8"	94 1/2"



VERSAILLES

Product ID	H	P	F	L
MLD04X03X05VE	4 1/4"	2 1/2"	4 7/8"	96 1/8"

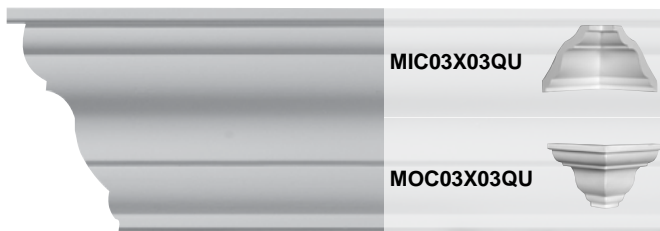

QUEENSTOWN

Product ID	H	P	F	L
MLD03X03X04QU	3 1/2"	3 1/8"	4 3/4"	94 1/2"



LEGACY

Product ID	H	P	F	L
MLD03X03X04LE	3 1/8"	3 1/2"	4 3/4"	94 5/8"

CROWN MOULDING

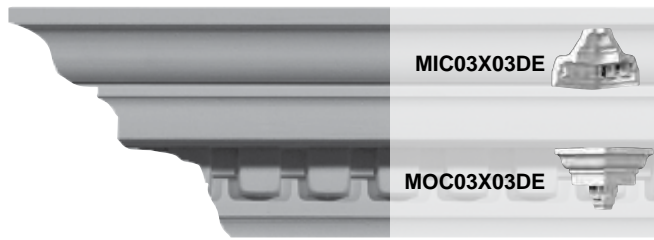

MIC03X03DE



MOC03X03DE



DEVON

Product ID	H	P	F	L	
MLD03X03X04DE	3 3/8"	3 3/8"	4 3/4"	94 1/2"	



TRADITIONAL SMOOTH

Product ID	H	P	F	L	
MLD03X03X04TR	3 3/8"	3 1/2"	4 3/4"	94 1/2"	



CROWN MOULDING



CORNELIA

Product ID	H	P	F	L
MLD03X03X04CN	3 1/2"	3 3/8"	4 3/4"	96"

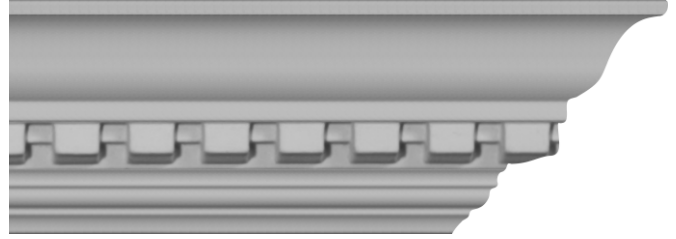

DENTIL

Product ID	H	P	F	L
MLD02X02X04DE	3"	2 3/4"	4 3/4"	96 1/8"



FLEUR DE LIS

Product ID	H	P	F	L
MLD03X03X05FL	3 1/4"	3 1/4"	4 3/4"	96"



FLEUR-DE-LIS

Product ID	H	P	F	L
MLD03X03X04FL	3 1/4"	3 1/2"	4 5/8"	96"



JACKSON

Product ID	H	P	F	L
MLD04X02X05JA	4 1/8"	2 1/4"	4 5/8"	96 1/8"



VICEROY

Product ID	H	P	F	L
MLD03X03X04VI	3 1/2"	3 1/8"	4 5/8"	94 5/8"



VICEROY

Product ID	H	P	F	L
MLD04X02X05VI	4"	2 1/2"	4 5/8"	94 1/2"



BEADED ROPE

Product ID	H	P	F	L
MLD03X03X04BD	3 1/4"	3 3/8"	4 5/8"	96"

CROWN MOULDING



CHAMBERLAIN

Product ID	H	P	F	L
MLD03X03X04CE	3 1/4"	3 3/8"	4 5/8"	94 3/8"

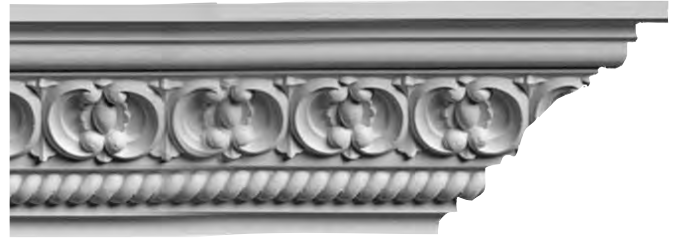

PEARL

Product ID	H	P	F	L
MLD03X03X05PE	3 1/4"	3 1/8"	4 5/8"	96"

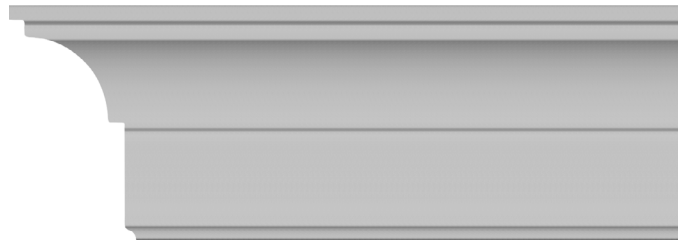

CLASSIC

Product ID	H	P	F	L
MLD04X02X05CL	3 5/8"	2 1/2"	4 5/8"	96 1/8"



FEDERAL

Product ID	H	P	F	L
MLD03X03X04FE	3"	3 5/8"	4 5/8"	94 1/2"



MEDWAY

Product ID	H	P	F	L
MLD03X03X04ME	3"	3 3/8"	4 1/2"	94 1/2"



MODERN VALERIANO ROPE

Product ID	H	P	F	L
MLD02X03X04VA	2 3/4"	3"	4 1/2"	94 1/2"



READ

Product ID	H	P	F	L
MLD03X03X04RE	3 1/8"	3 1/8"	4 1/2"	94 5/8"



SOUTHAMPTON

Product ID	H	P	F	L
MLD03X03X04SO	3 1/8"	3 1/8"	4 1/2"	94 1/2"

CROWN MOULDING

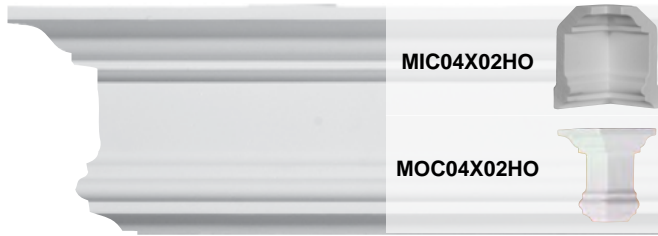

HOLMDEL

Product ID	H	P	F	L	
MLD04X02X04HO	4"	2 1/4"	4 1/2"	94 1/2"	



HAMPSHIRE

Product ID	H	P	F	L	
MLD03X02X04HA	3 7/8"	2 1/8"	4 1/2"	94 1/2"	

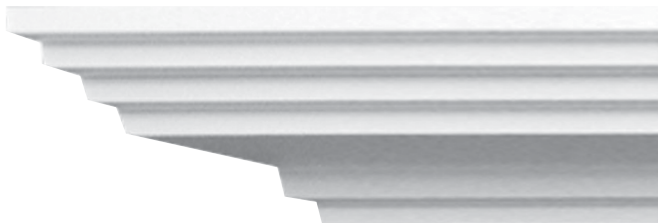

ADONIS

Product ID	H	P	F	L	
MLD01X04X04AD	1 3/4"	4"	4 1/2"	94 1/2"	



SALEM TRADITIONAL

Product ID	H	P	F	L	
MLD03X03X04SA	3 1/4"	3 1/4"	4 1/2"	94 1/2"	



SEQUENTIAL

Product ID	H	P	F	L	
MLD04X02X04SQ	4"	2 1/8"	4 1/2"	94 1/2"	



AMELIA

Product ID	H	P	F	L	
MLD04X02X04AM	3 7/8"	2 1/8"	4 1/2"	96 1/8"	

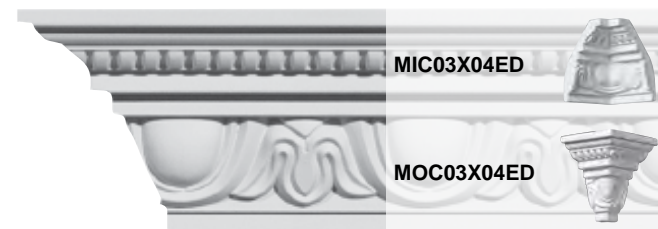

EDINBURGH

Product ID	H	P	F	L	
MLD04X03X05ED	3 1/2"	2 5/8"	4 3/8"	94 5/8"	



ROSE

Product ID	H	P	F	L	
MLD03X03X04RO	3 1/8"	3 1/8"	4 3/8"	94 5/8"	

CROWN MOULDING

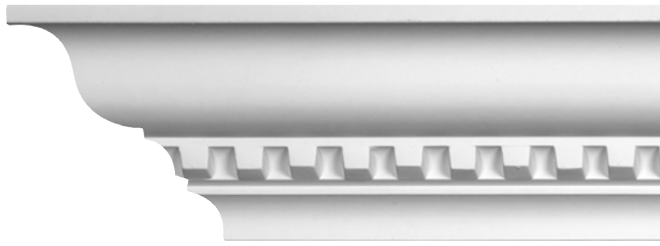

DENTIL

Product ID	H	P	F	L	
MLD03X03X05DE	3 1/4"	3 1/4"	4 3/8"	96"	



COLTON

Product ID	H	P	F	L	
MLD03X03X04CO	3 1/4"	3 1/8"	4 3/8"	96"	

PAIR WITH **PANEL MOULDING** FOR A
UNIQUELY **ELEGANT WALL.**



ALEXANDRIA

Product ID	H	P	F	L
MLD03X02X04AL	3 7/8"	2 1/8"	4 3/8"	94 5/8"



TRADITIONAL EGG & DART

Product ID	H	P	F	L	
MLD03X02X04TR	3 1/4"	2 3/4"	4 3/8"	96"	

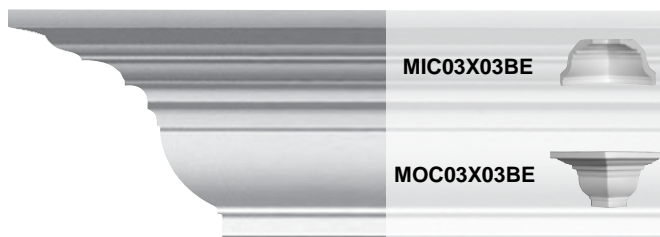

BEDFORD

Product ID	H	P	F	L	
MLD03X03X04BE	3"	3 1/2"	4 3/8"	94 1/2"	



KENDALL

Product ID	H	P	F	L	
MLD03X03X04KD	3 1/8"	2 7/8"	4 1/4"	94 1/2"	

CROWN MOULDING



ROBERTS

Product ID	H	P	F	L	
MLD03X02X04RO	3 1/4"	2 7/8"	4 1/4"	94 1/2"	

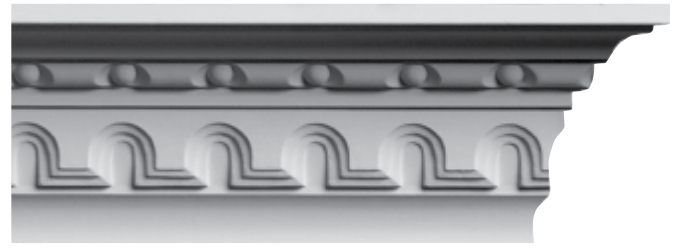

HEATON

Product ID	H	P	F	L	
MLD04X02X04HE	3 5/8"	2 1/4"	4 1/4"	94 1/2"	

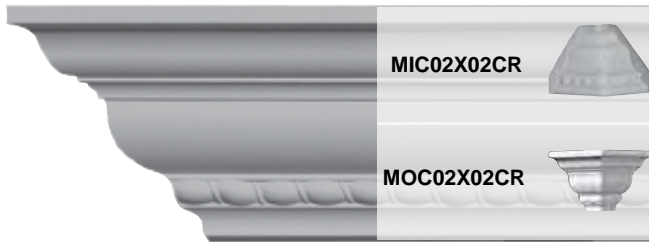

CRENDON

Product ID	H	P	F	L	
MLD02X02X04CR	3"	3"	4 1/4"	94 1/2"	



NEXUS

Product ID	H	P	F	L	
MLD02X03X04NE	2 3/4"	3 1/8"	4 1/4"	94 5/8"	



ERIS

Product ID	H	P	F	L	
MLD03X02X04ER	3 1/2"	2 1/4"	4 1/4"	94 3/4"	



EGG & DART

Product ID	H	P	F	L	
MLD02X03X04EG	2 3/4"	3 1/8"	4 1/4"	94 1/2"	

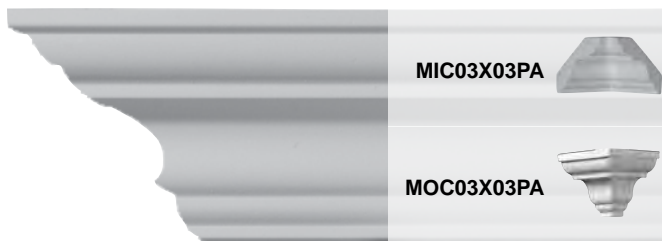

PALMETTO SMOOTH

Product ID	H	P	F	L	
MLD03X03X04PA	3"	3"	4 1/4"	94 1/2"	



DENTIL

Product ID	H	P	F	L	
MLD03X03X04DT	3"	3"	4 1/4"	94 1/2"	

CROWN MOULDING

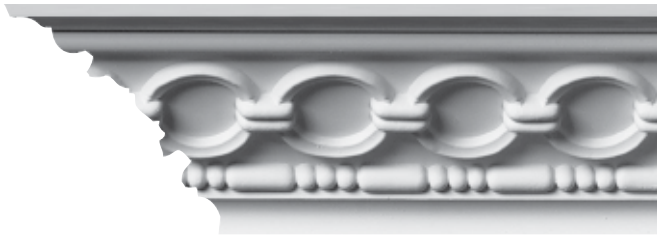

FOSTER COIN & BEAD

Product ID	H	P	F	L	
MLD03X03X04FO	3 1/8"	3 1/8"	4 1/4"	96"	



JACKSON EGG & DART WITH ROPE

Product ID	H	P	F	L	
MLD03X03X04JA	3"	3"	4 1/4"	96"	



DAUPHINE

Product ID	H	P	F	L	
MLD03X02X04DA	3 1/4"	2 7/8"	4 1/8"	94 5/8"	



GORLEEN

Product ID	H	P	F	L	
MLD03X02X04GO	3 1/8"	2 3/4"	4 1/8"	94 1/2"	



LANKSHIRE

Product ID	H	P	F	L	
MLD03X02X04LA	3"	2 7/8"	4 1/8"	94 5/8"	

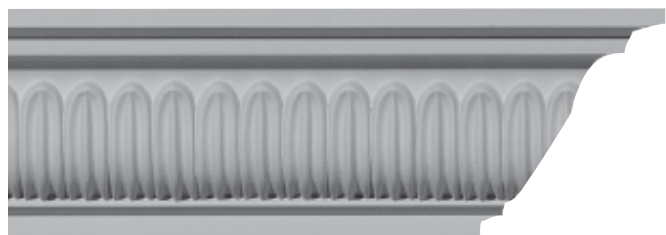

FLORAL

Product ID	H	P	F	L	
MLD04X02X04FL	3"	2 3/4"	4 1/8"	94 1/2"	



QUENTIN

Product ID	H	P	F	L	
MLD02X02X04QU	3"	3"	4"	94 5/8"	



EGG & DART

Product ID	H	P	F	L	
MLD02X02X04EG	2 1/4"	2 1/2"	4"	94 5/8"	

CROWN MOULDING



SHELL

Product ID	H	P	F	L
MLD02X02X02SH	2 7/8"	2 3/4"	4"	94 5/8"



TRISTAN

Product ID	H	P	F	L
MLD02X02X04TN	2 3/4"	2 3/4"	4"	94 1/2"



SEQUENTIAL

Product ID	H	P	F	L
MLD03X01X04SQ	3 1/2"	1 7/8"	4"	94 1/2"



MEDWAY

Product ID	H	P	F	L
MLD03X02X04ME	3 3/8"	2 1/8"	4"	94 5/8"

CROWN MOULDING



MELONIE EGG & DART

Product ID	H	P	F	L	
MLD02X02X04ML	2 3/4"	2 3/4"	4"	96"	



VALERIANO

Product ID	H	P	F	L	
MLD03X02X04VA	3"	2 1/2"	4"	96"	

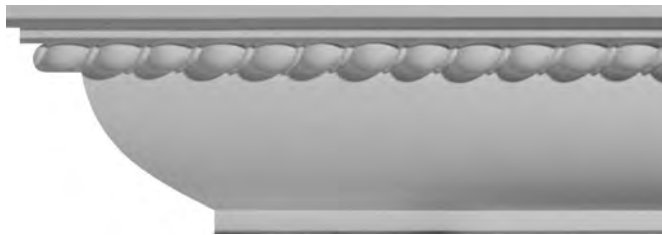

VALERIANO

Product ID	H	P	F	L	
MLD03X03X04VA	2 3/4"	2 3/4"	4"	96"	



BULWARK

Product ID	H	P	F	L	
MLD03X02X04BU	3 1/4"	2 3/8"	4"	96"	



CLASSIC TWIST

Product ID	H	P	F	L	
MLD03X03X04CL	2 7/8"	2 3/4"	3 7/8"	96"	



QUENTIN

Product ID	H	P	F	L	
MLD02X02X03QU	2 1/2"	2 7/8"	3 7/8"	94 1/2"	



TELMA TWISTED LEAF

Product ID	H	P	F	L	
MLD03X02X04TE	2 7/8"	2 1/2"	3 7/8"	96"	



partnering with contractors, installers, designers, & architects

CROWN MOULDING

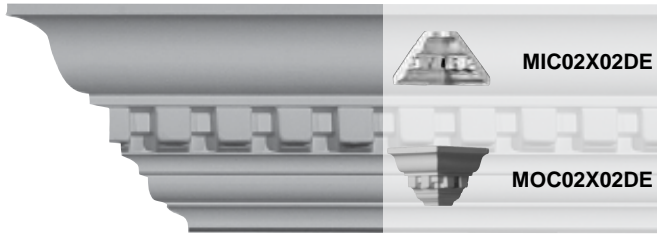

DENTIL

Product ID	H	P	F	L	
MLD02X02X03DE	2 3/4"	2 3/4"	3 7/8"	94 5/8"	



GRAPEVINE

Product ID	H	P	F	L	
MLD03X03X04GV	2 3/4"	2 3/4"	3 7/8"	94 1/2"	



HEATON

Product ID	H	P	F	L	
MLD03X02X03HE	3 1/8"	2 3/4"	3 7/8"	94 5/8"	



DUBLIN

Product ID	H	P	F	L	
MLD02X02X03DU	2 3/4"	2 3/4"	3 7/8"	94 1/2"	



ORION

Product ID	H	P	F	L	
MLD02X02X03OR	2 3/4"	2 3/4"	3 7/8"	94 1/2"	



LOERA

Product ID	H	P	F	L	
MLD03X03X04LO	2 7/8"	2 7/8"	3 7/8"	94 7/8"	



EMPIRE

Product ID	H	P	F	L	
MLD02X03X04EM	2 3/8"	3 1/8"	3 3/4"	96"	

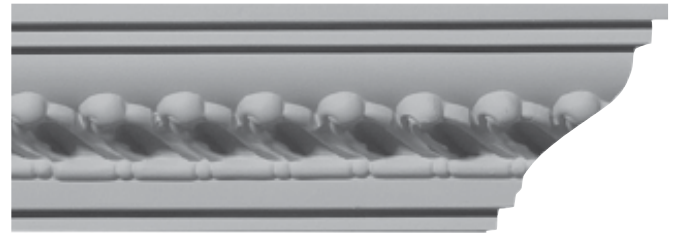

BARCELONA

Product ID	H	P	F	L	
MLD02X02X03BA	2 3/4"	2 1/2"	3 3/4"	94 5/8"	

CROWN MOULDING

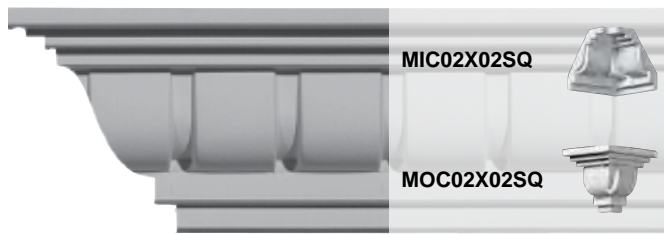

SEQUENTIAL

Product ID	H	P	F	L	
MLD02X02X03SQ	2 5/8"	2 3/4"	3 3/4"	94 5/8"	



FLORAL

Product ID	H	P	F	L	
MLD03X02X03FL	3 1/8"	2 1/8"	3 3/4"	94 5/8"	

classic

ARCHITECTURAL

detail



ARTIS SMOOTH

Product ID	H	P	F	L	
MLD02X02X01AR	2 3/4"	2 1/2"	3 3/4"	94 1/2"	



ANTHONY

Product ID	H	P	F	L	
MLD02X02X03AT	2 1/2"	2 1/8"	3 3/4"	94 1/2"	



WHITMAN

Product ID	H	P	F	L	
MLD02X02X04WH	2 1/2"	2 1/2"	3 5/8"	96 1/8"	

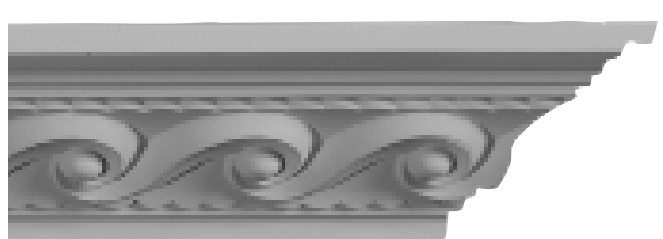

MARSILLE FRENCH

Product ID	H	P	F	L	
MLD03X02X04MA	2 5/8"	2 3/8"	3 5/8"	96"	

CROWN MOULDING



FOSTER RUNNING COIN

Product ID	H	P	F	L	
MLD03X02X04FO	2 7/8"	2 1/4"	3 5/8"	96"	

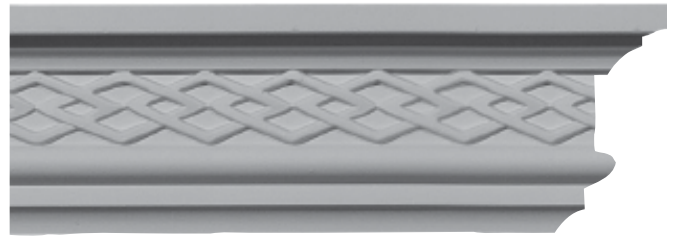

BRIGHTON

Product ID	H	P	F	L	
MLD03X01X03BR	3 1/8"	1 7/8"	3 5/8"	94 5/8"	



DENTIL

Product ID	H	P	F	L	
MLD03X02X03DE	3"	2"	3 5/8"	94 1/2"	



TRADITIONAL SMOOTH

Product ID	H	P	F	L	
MLD03X02X03TR	3"	2"	3 5/8"	94 1/2"	



LISBON

Product ID	H	P	F	L	
MLD03X02X03LI	3"	2"	3 5/8"	94 1/2"	



FEDERAL

Product ID	H	P	F	L	
MLD02X02X03FE	2 3/8"	2 7/8"	3 5/8"	94 1/2"	

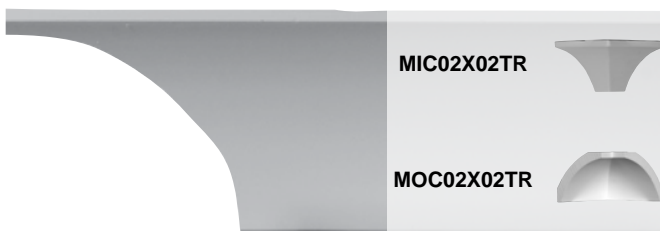

TRADITIONAL

Product ID	H	P	F	L	
MLD02X02X03TR	2 3/8"	2 5/8"	3 5/8"	94 1/2"	



ORION

Product ID	H	P	F	L	
MLD03X03X03OR	2 1/2"	2 1/2"	3 1/2"	94 5/8"	

CROWN MOULDING

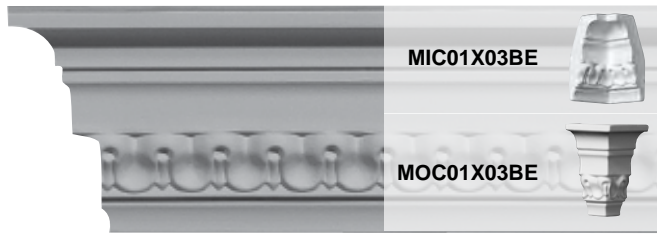

RAYNOR

Product ID	H	P	F	L	
MLD03X01X03BE	3 1/8"	1 1/2"	3 1/2"	94 5/8"	



SUSSEX

Product ID	H	P	F	L	
MLD03X01X05SU	3 1/4"	1 3/8"	3 1/2"	95"	



ASA SMOOTH

Product ID	H	P	F	L	
MLD02X01X03AS	2 7/8"	1 7/8"	3 1/2"	94 1/2"	



EGG & DART

Product ID	H	P	F	L	
MLD03X01X03EG	3"	1 1/2"	3 3/8"	94 5/8"	

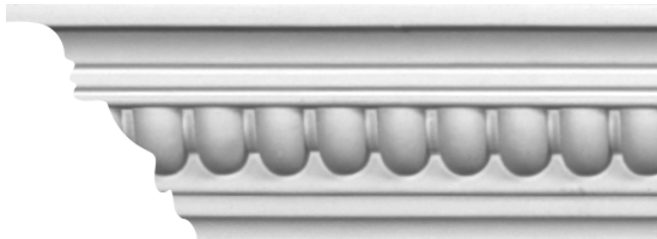

HELENE

Product ID	H	P	F	L	
MLD02X02X04HE	2 3/8"	2 3/8"	3 3/8"	96 1/8"	



LOERA

Product ID	H	P	F	L	
MLD02X02X03LO	2 1/2"	2 3/8"	3 3/8"	94 3/8"	



CLASSIC SMOOTH

Product ID	H	P	F	L	
MLD02X02X04CL	2 3/8"	2 3/8"	3 3/8"	94 1/2"	



EDINBURGH ROPED

Product ID	H	P	F	L	
MLD02X02X03ED	2 1/4"	2 3/8"	3 1/4"	96"	

CROWN MOULDING



TIRANA

Product ID	H	P	F	L	
MLD02X02X03TI	2 3/8"	2 3/8"	3 1/4"	96"	



DENTIL

Product ID	H	P	F	L	
MLD03X01X03DE	2 3/4"	1 7/8"	3 1/4"	96"	



DENTIL

Product ID	H	P	F	L	
MLD02X01X03DE	2 7/8"	1 1/2"	3 1/4"	94 5/8"	



JEFFERSON TRADITIONAL SMOOTH

Product ID	H	P	F	L	
MLD02X02X03JE	2 1/4"	2 1/4"	3 1/4"	94 1/2"	



CLASSIC

Product ID	H	P	F	L	
MLD02X01X03CL	2 1/4"	2 1/4"	3 1/8"	94 1/2"	

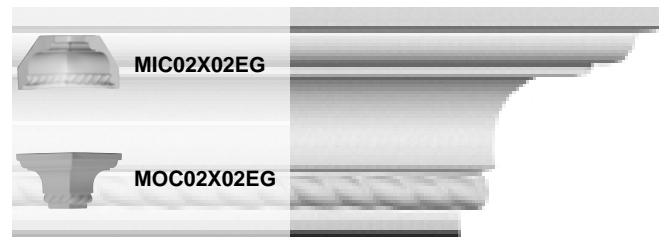

LEANDROS ROPE

Product ID	H	P	F	L	
MLD02X02X06LN	2 1/4"	2 1/4"	3 1/8"	94 1/2"	



PIEDMONT

Product ID	H	P	F	L	
MLD02X01X03PI	2 3/4"	1 1/2"	3 1/8"	94 5/8"	



NEXUS

Product ID	H	P	F	L	
MLD02X02X03NE	2 3/4"	1 1/2"	3 1/8"	94 1/2"	

CROWN MOULDING



BLACKTHORNE

Product ID	H	P	F	L	
MLD02X02X03BL	2 1/4"	2"	3 1/8"	94 5/8"	



LOERA

Product ID	H	P	F	L	
MLD03X02X03LO	2 1/2"	2 1/8"	3"	94 1/2"	



LEGACY

Product ID	H	P	F	L	
MLD02X01X03LE	2 1/2"	1 5/8"	3"	94 5/8"	



EGG & DART

Product ID	H	P	F	L	
MLD02X02X03EG	2 1/8"	2 1/8"	3"	94 5/8"	



LYNON TRADITIONAL SMOOTH

Product ID	H	P	F	L	
MLD02X02X03LY	2"	2"	3"	94 1/2"	



ERIS SMOOTH

Product ID	H	P	F	L	
MLD02X02X03ER	2 1/4"	2 1/4"	3"	96"	



EDWARDS

Product ID	H	P	F	L	
MLD03X02X03ED	2 5/8"	1 5/8"	3"	96"	



DENTIL

Product ID	H	P	F	L	
MLD02X02X02DE	2"	2"	2 7/8"	96"	

CROWN MOULDING



HAMPSHIRE

Product ID	H	P	F	L	
MLD02X02X03HA	2"	2"	2 7/8"	96"	



ASHUR LEAF

Product ID	H	P	F	L	
MLD02X01X02AS	2 5/8"	1 1/4"	2 7/8"	94 1/2"	

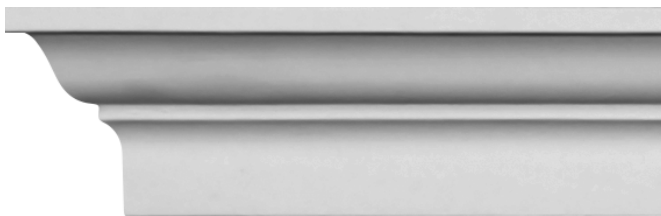

ROBIN

Product ID	H	P	F	L	
MLD02X02X03RO	2 3/8"	1 5/8"	2 7/8"	96 1/8"	



MARSEILLE TRADITIONAL SMOOTH

Product ID	H	P	F	L	
MLD02X02X02MA	2"	2"	2 3/4"	96"	

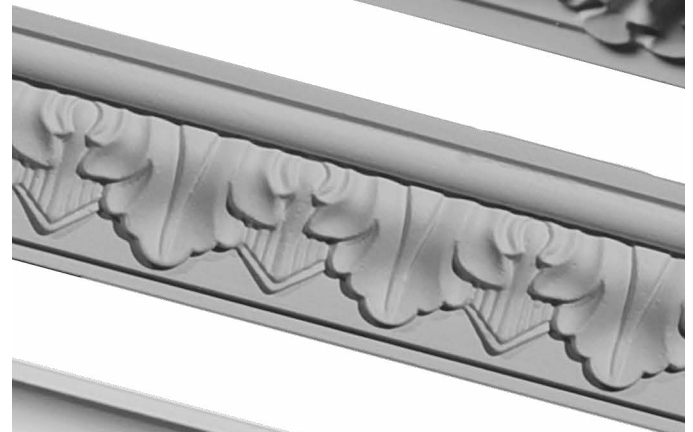
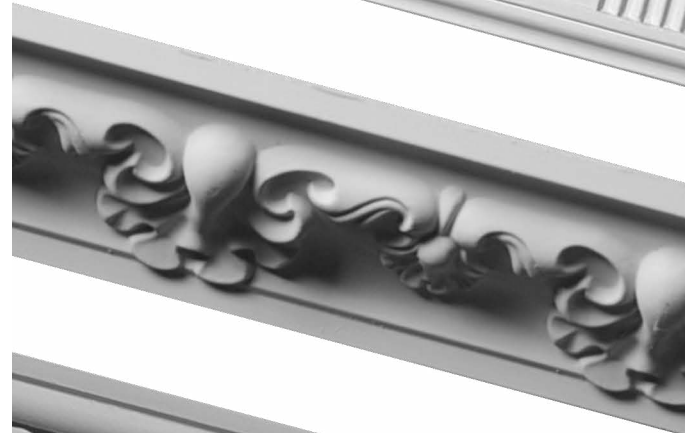

CROWN MOULDING

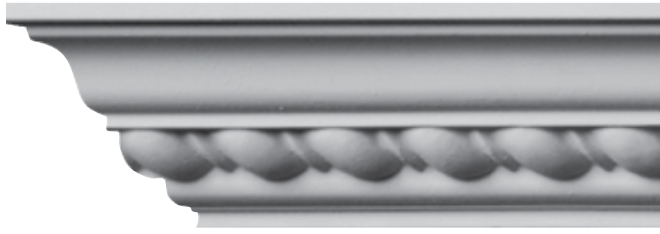

CLASSIC ROPED

Product ID	H	P	F	L	
MLD01X01X02CL	1 7/8"	1 7/8"	2 3/4"	96"	



KENT

Product ID	H	P	F	L	
MLD02X02X02KE	2"	2"	2 3/4"	96"	



MIDDLESBOROUGH TRADITIONAL SMOOTH

Product ID	H	P	F	L	
MLD02X02X02MD	2"	2"	2 3/4"	96"	



REECE

Product ID	H	P	F	L	
MLD02X01X02RE	2"	1 7/8"	2 3/4"	94 1/2"	



EDINBURGH TRADITIONAL

Product ID	H	P	F	L	
MLD01X02X02ED	2"	2"	2 3/4"	94 1/2"	



GIANA

Product ID	H	P	F	L	
MLD02X02X02GI	2"	2"	2 3/4"	96"	

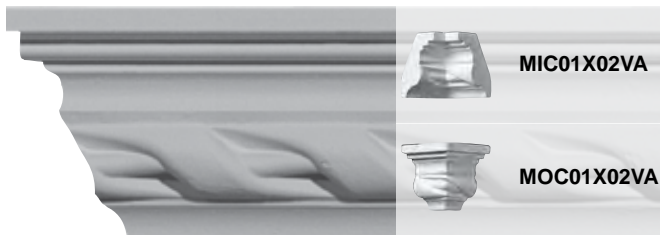

VALERIANO

Product ID	H	P	F	L	
MLD02X01X02VA	2 1/8"	1 5/8"	2 5/8"	94 1/2"	



TRADITIONAL SMOOTH

Product ID	H	P	F	L	
MLD01X01X02TR	1 3/4"	1 3/4"	2 5/8"	94 1/2"	

CROWN MOULDING



ODESSA

Product ID	H	P	F	L
MLD02X02X03WH	2"	2"	2 3/4"	96 1/8"



EDINBURGH

Product ID	H	P	F	L
MLD01X01X02ED	1 3/4"	1 3/4"	2 1/2"	94 1/2"

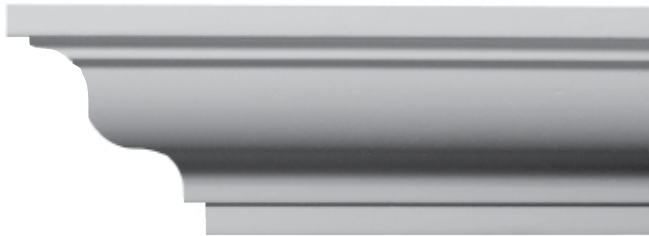

JACKSON TRADITIONAL SMOOTH

Product ID	H	P	F	L
MLD01X01X02JA	1 5/8"	1 5/8"	2 1/4"	96"

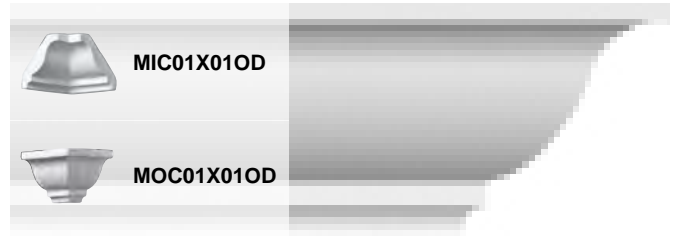

ODESSA

Product ID	H	P	F	L
MLD01X01X02OD	1 5/8"	1 5/8"	2 1/4"	94 1/2"



TYRONE SMOOTH

Product ID	H	P	F	L
MLD01X01X02TY	1 1/2"	1 1/2"	2 1/4"	96"



BEDFORD

Product ID	H	P	F	L
MLD01X01X02BE	1 1/2"	1 1/2"	2 1/4"	96"



ASHFORD

Product ID	H	P	F	L
MLD01X01X02AS	1 1/2"	1 1/2"	2 1/8"	96"



HILLSBOROUGH TRADITIONAL SMOOTH

Product ID	H	P	F	L
MLD01X01X01HI	1 1/4"	1 1/4"	1 3/4"	94 1/2"

UNIVERSAL MOULDING BLOCKS

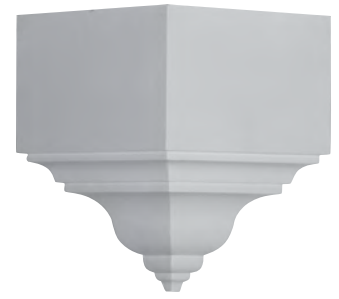
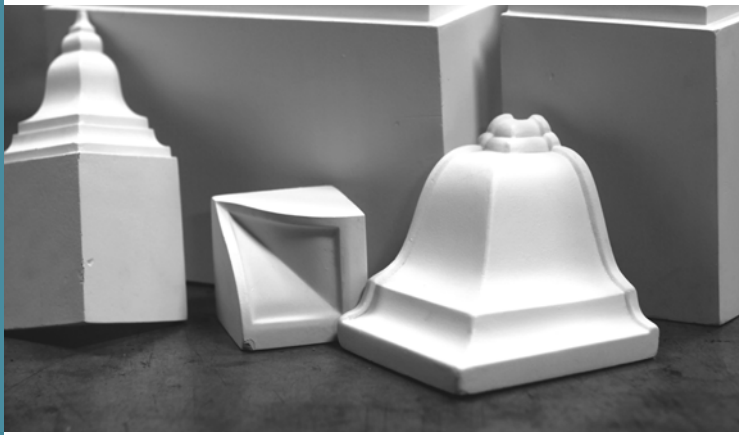

OUTSIDE CORNER

Product ID	H	P	W	
MOC05X06BI	13 3/4"	5 1/2"	11"	* Fits moulding profiles less than 5 1/2" by 6 3/4"



MOULDING COUPLING

Product ID	H	P	W	
MDB05X06BI	13 3/4"	5 1/2"	11"	* Fits moulding profiles less than 5 1/2" by 6 3/4"



INSIDE CORNER

Product ID	H	P	W	
MIC05X06BI	13 3/4"	5 1/2"	5 1/2"	* Fits moulding profiles less than 5 1/2" by 6 3/4"



OUTSIDE CORNER

Product ID	H	P	W	
MOC03X03BI	7 3/4"	3 1/8"	8 3/4"	* Fits moulding profiles less than 3 1/8" by 3 7/8"



MOULDING COUPLING

Product ID	H	P	W	
MDB03X03BI	7 3/4"	3 1/8"	6 1/4"	* Fits moulding profiles less than 3 1/8" by 3 7/8"



INSIDE CORNER

Product ID	H	P	W	
MIC03X03BI	7 3/4"	3 1/8"	3 1/8"	* Fits moulding profiles less than 3 1/8" by 3 7/8"



OUTSIDE CORNER

Product ID	H	P	
MOC03X03	3 5/8"	3 1/2"	

UNIVERSAL MOULDING BLOCKS

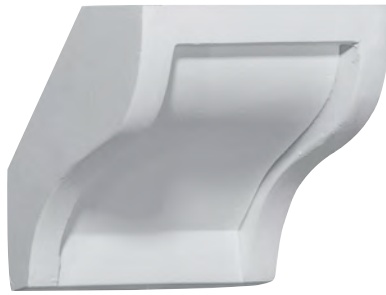

MOULDING COUPLING

Product ID	H	P	W
MDB03X03	3 5/8"	3 1/2"	4"

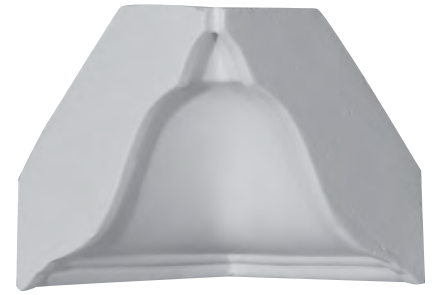

INSIDE CORNER

Product ID	H	P
MIC03X03	3 5/8"	3 1/2"



OUTSIDE CORNER

Product ID	H	P
MOC04X04BX	4 5/8"	5 1/8"



MOULDING COUPLING

Product ID	H	P	W
MDB04X04BX	4 5/8"	4 5/8"	4 5/8"

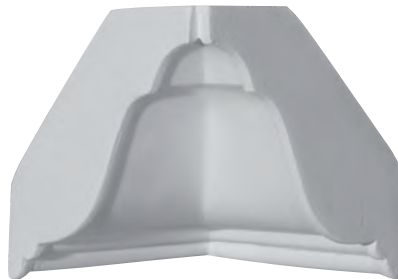

INSIDE CORNER

Product ID	H	P
MIC04X04BX	4 3/4"	4 7/8"

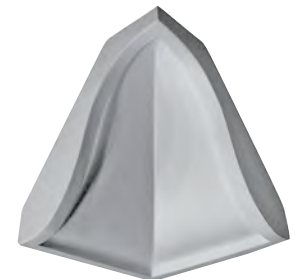

INSIDE CORNER

Product ID	H	P
MIC09X06	5 7/8"	8 3/4"



OUTSIDE CORNER

Product ID	H	P
MOC09X06	5 7/8"	8 3/4"



OUTSIDE CORNER

Product ID	H	P
MOC04X04	4 3/8"	4 5/8"

UNIVERSAL MOULDING BLOCKS



MOULDING COUPLING

Product ID	H	P	W
MDB04X04	4 3/4"	4 5/8"	4"



INSIDE CORNER

Product ID	H	P
MIC04X04	4 5/8"	4 5/8"



OUTSIDE CORNER

Product ID	H	P	W
MIC03X03CH	2 7/8"	3 5/8"	3 5/8"

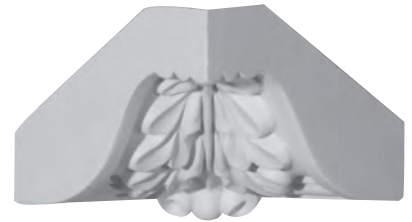

INSIDE CORNER

Product ID	H	P	W
MOC03X03CH	2 7/8"	3 5/8"	3 5/8"



OUTSIDE CORNER

Product ID	H	P
MOC03X03BE	3"	3"



MOULDING COUPLING

Product ID	H	P	W
MDB03X03BE	3"	3"	3 1/4"



INSIDE CORNER

Product ID	H	P
MIC03X03BE	3"	3"

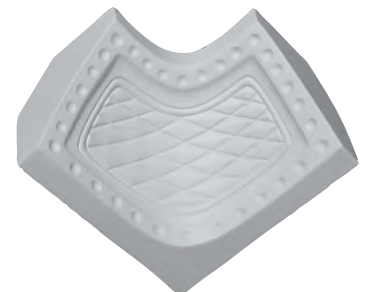

INSIDE CORNER

Product ID	H	P
MIC02X02HE	2 1/2"	2 1/2"

UNIVERSAL MOULDING BLOCKS

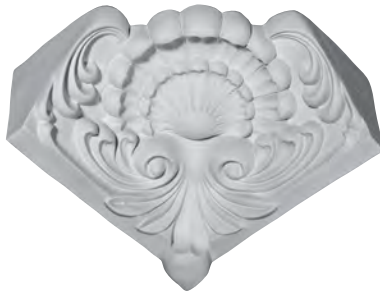

INSIDE CORNER

Product ID	H	P
MIC02X03LI	2 3/4"	3 1/8"



INSIDE CORNER

Product ID	H	P
MIC03X03ED	3 3/4"	3 3/4"



INSIDE CORNER

Product ID	H	P
MIC03X03HI	3 3/8"	3"



INSIDE CORNER

Product ID	H	P
MIC04X03ME	3 3/4"	4 1/8"



INSIDE CORNER

Product ID	H	P
MIC04X03MO	4 3/4"	3 5/8"



INSIDE CORNER

Product ID	H	P
MIC04X04DY	4 1/8"	4 1/8"

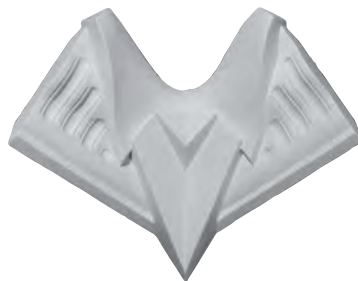

INSIDE CORNER

Product ID	H	P
MIC04X04FO	4 1/8"	4 1/2"



INSIDE CORNER

Product ID	H	P
MIC05X05SM	5 1/8"	5 1/8"

PANEL MOULDING SYSTEMS



TRADITIONAL

Product ID	H	P	L
PML00X00TR	• 3/4"	• 3/8"	• 94"



Product ID	H	W
PML03X03TR	• 3 1/8"	• 3 1/8"
PML04X04TR	• 4"	• 4"
PML05X05TR	• 5 1/8"	• 5 1/8"
PML06X06TR	• 6"	• 6"
PML08X08TR	• 8"	• 8"
PML10X10TR	• 10"	• 10"

PANEL MOULDING SYSTEMS

BRADFORD SMOOTH

Product ID	H	P	L
PML01X01BR	7/8"	1/2"	96"



Product ID	H	W
PML06X06BR	6 1/2"	6 1/2"



Product ID	H	W
PML04X05BR	4 1/8"	4 1/8"
PML05X05BR	5 7/8"	5 7/8"



Product ID	H	W
PML04X04BR	4 1/8"	4 1/8"



CLASSIC

Product ID	H	P	L
PML00X00CL	7/8"	1/2"	96"



Product ID	H	W
PML03X03WA	3 1/8"	3 1/8"
PML05X05CL	5 1/8"	5 1/8"
PML06X06CL	6"	6"
PML08X08CL-2	8"	8"
PML10X10CL	10"	10"



ODESSA

Product ID	H	P	L
PML00X00OD	7/8"	3/8"	94 1/2"



Product ID	H	W
PML08X08OD	8 1/4"	8 1/4"



PANEL MOULDING SYSTEMS



BULWARK ROPE

Product ID	H	P	L
MLD01X00BU	1"	5/8"	96"



Product ID	H	W
PML04X04BU	4"	4"
PML06X06BU	6"	6"



Product ID	H	W
PML08X08BU	8"	8"
PML10X10BU	10"	10"



NEXUS ACANTHUS LEAF

Product ID	H	P	L
PML01X00NE	1 1/4"	1/2"	94 1/2"



Product ID	H	W
PML08X08NE	8 1/2"	8 1/2"



Product ID	H	W
PML11X11NE	11"	11"



Product ID	H	W
PML06X06NE	6 1/2"	6 1/2"



Product ID	H	W
PML04X04NE	4"	4"
PML06X06NE-2	6"	6"
PML08X08NE-2	8"	8"

don't see the perfect panel moulding?

ask us!

PANEL MOULDING SYSTEMS

KEPLER

Product ID	H	P	L
PML01X01KP	1 1/8"	1/2"	94 1/2"

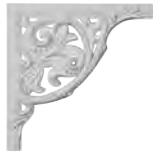

Product ID	H	W
PML11X11KP	11"	11"

MIDDLESBOROUGH EGG & DART

Product ID	H	P	L
PML01X00MD	1 1/4"	3/8"	94 1/2"



Product ID	H	W
PML08X08MD	8 3/8"	8 3/8"

STOCKPORT

Product ID	H	P	L
PML01X00ST	1 1/4"	5/8"	96"



Product ID	H	W
PML08X08ST	8 5/8"	8 1/2"



Product ID	H	W
PML04X04ST	4"	4"
PML06X06ST	6 5/8"	6 5/8"
PML08X08ST-2	8"	8"
PML10X10ST	10"	10"
PML12X12ST	12"	12"

DUBLIN

Product ID	H	P	L
PML01X01DU	1 3/8"	3/4"	94 1/2"



Product ID	H	W
PML07X07DU	7 7/8"	7 7/8"

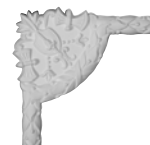

Product ID	H	W
PML09X09DU	9 1/2"	9 1/2"

WIDTH

HEIGHT

LENGTH

PROJECTION

PANEL MOULDING SYSTEMS



ASHFORD

Product ID	H	P	L
PML01X00AS	1 1/2"	1/2"	96"



Product ID	H	W
PML09X09AS	9"	9"



Product ID	H	W
PML08X08AS-3	8"	8"



Product ID	H	W
PML07X07AS-2	7 7/8"	7 7/8"



Product ID	H	W
PML10X10AS	9 3/4"	9 3/4"



Product ID	H	W
PML04X04AS	4"	4"



Product ID	H	W
PML09X04AS	4 1/4"	9 1/4"



Product ID	H	W
PML06X06AS	6 1/8"	6 1/8"

Product ID	H	W
PML08X08AS-2	8"	8"

Product ID	H	W
PML10X10AS-2	10"	10"

Product ID	H	W
PML12X12AS	12"	12"



Product ID	H	W
PML08X08AS	8 1/4"	8 1/4"

simply
elegant

ABERDEEN

Product ID	H	P	L
PML01X00AB	1 1/2"	3/4"	94 1/4"



Product ID	H	W
PML08X08AB	8 1/4"	8 1/8"
PML11X11AB	11 1/4"	11 1/4"

SEVILLE

Product ID	H	P	L
PML01X00SE	1 1/2"	3/4"	96"



Product ID	H	W
PML10X10SE-1	10"	10"



Product ID	H	W
PML05X05SE	5 1/8"	5 1/8"



Product ID	H	W
PML08X08SE	8"	8"



Product ID	H	W
PML04X04SE	4"	4"
PML06X06SE-2	6"	6"
PML08X08SE-2	8"	8"
PML10X10SE	10 1/2"	10 1/2"
PML12X12SE	12"	12"

ERIS

Product ID	H	P	L
PML01X00ER	1 5/8"	3/4"	94 1/2"



Product ID	H	W
PML03X03ER	3 3/8"	3 3/8"

PANEL MOULDING SYSTEMS

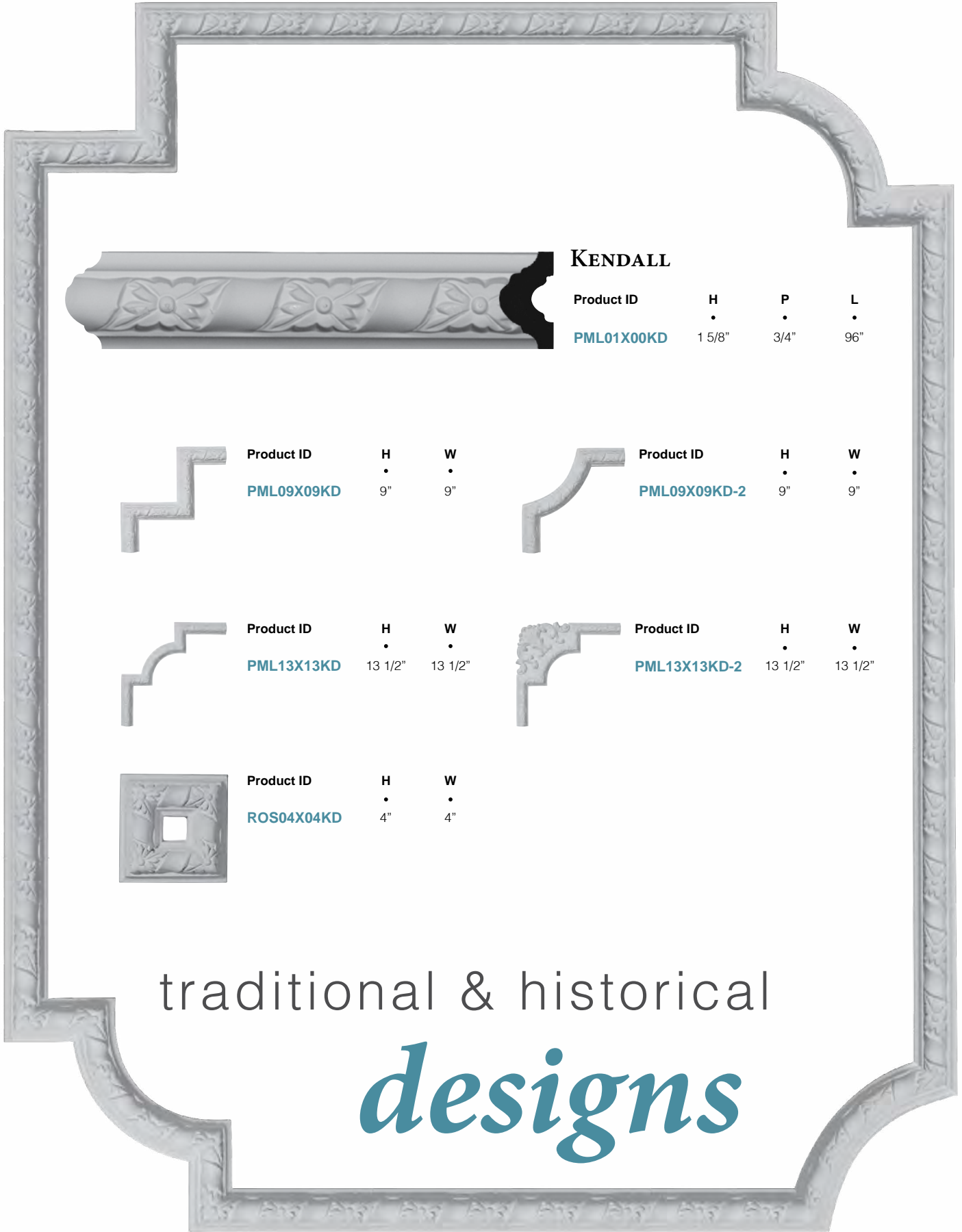

KENDALL

Product ID	H	P	L
PML01X00KD	1 5/8"	3/4"	96"



Product ID	H	W
PML09X09KD	9"	9"



Product ID	H	W
PML09X09KD-2	9"	9"



Product ID	H	W
PML13X13KD	13 1/2"	13 1/2"



Product ID	H	W
PML13X13KD-2	13 1/2"	13 1/2"



Product ID	H	W
ROS04X04KD	4"	4"

traditional & historical
designs

PANEL MOULDING SYSTEMS

JACKSON FRENCH RIBBON

Product ID	H	P	L
PML01X00JA	1 5/8"	3/4"	94 1/2"



Product ID	H	W
PML11X11JA	11 3/4"	11 3/8"



Product ID	H	W
PML06X06JA	6"	6"
PML10X10JA	10"	10"
PML12X12JA	12"	12"



Product ID	H	W
PML09X09JA	9"	9"

SWINDON

Product ID	H	P	L
PML01X00SW	1 5/8"	1/2"	94 1/2"



Product ID	H	W
PML06X06SW	6"	6"
PML09X09SW	7 3/4"	7 3/4"
PML10X10SW	10"	10"
PML12X12SW	12"	12"

CLAREMONT

Product ID	H	P	L
PML01X00CL	1 3/4"	1/2"	96"



Product ID	H	W
PML08X08CL	8 3/4"	8 3/4"



Product ID	H	W
PML12X12CL	12 1/2"	12 1/2"

PANEL MOULDING SYSTEMS



HILLSBOROUGH

Product ID	H	P	L
PML01X01HI	1 3/4"	5/8"	94 1/2"



Product ID	H	W
PML07X11HI-L	11"	7"



Product ID	H	W
PML07X11HI-R	11"	7"



Product ID	H	W
PML15X15HI	15"	15"



LANARKSHIRE

Product ID	H	P	L
PML01X00LA	1 3/4"	5/8"	94 1/2"



Product ID	H	W
PML11X11LA	11 3/4"	11 3/4"



REDED ACANTHUS LEAF

Product ID	H	P	L
PML01X01AC	1 3/4"	1 1/8"	94 1/2"



Product ID	H	W
PML06X06AC	6"	6"
PML08X08AC	8 7/8"	8 7/8"
PML12X12AC	12"	12"

PANEL MOULDING SYSTEMS

SELLEK

Product ID	H	P	L
PML01X01SK	1 3/4"	1"	94 1/2"



Product ID	H	W
PML11X11SK	11 1/8"	11 1/8"

MILTON

Product ID	H	P	L
PML02X00MI	2"	3/4"	94 1/2"



Product ID	H	W
PML09X09MI-2	9 3/4"	9 3/4"



Product ID	H	W
PML06X06MI	6"	6"
PML10X10MI	10"	10"



Product ID	H	W
PML12X12MI	12 3/4"	12 3/4"



Product ID	H	W
PML10X10MI-2	10"	10"

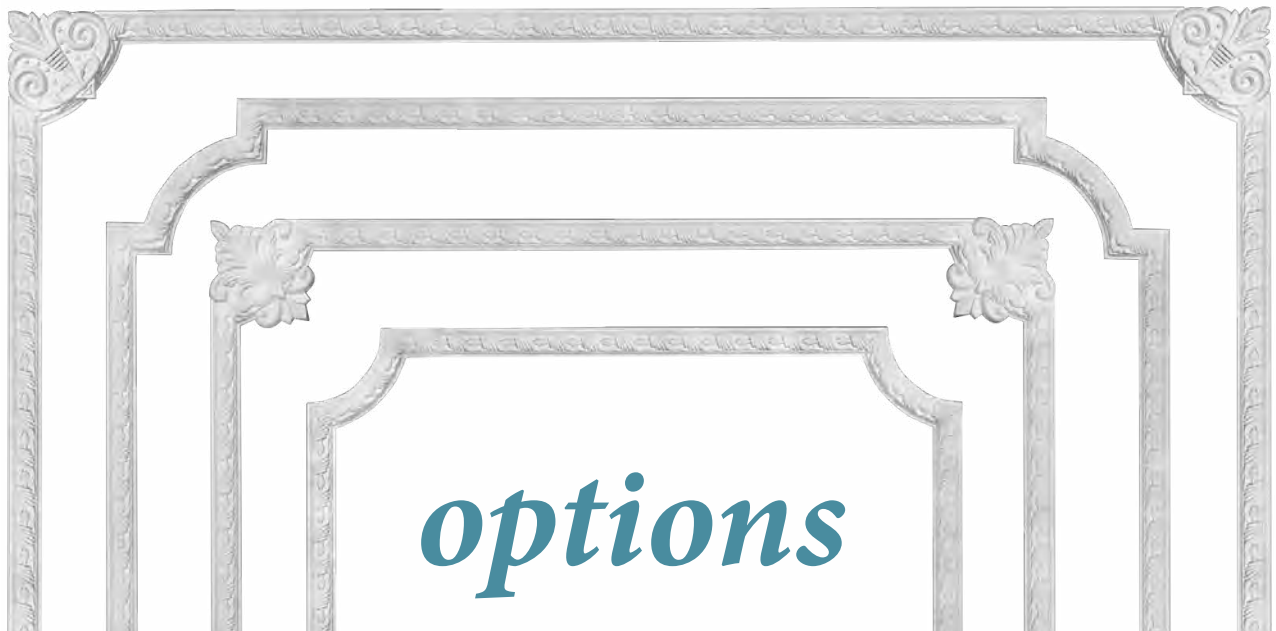

options

PANEL MOULDING SYSTEMS



TIRANA

Product ID	H	P	L
PML01X00TI	1 3/4"	3/4"	96"



Product ID	H	W
PML14X14TI	14 1/4"	14 1/4"



Product ID	H	W
PML16X18TI-L	18 1/8"	16 1/2"



Product ID	H	W
PML16X18TI-R	18 1/8"	16 1/2"



ARTIS

Product ID	H	P	L
PML01X00AR	1 7/8"	3/4"	94 1/2"



Product ID	H	W
PML13X13AR	13"	13"



*Choose the corner
that suits you best!*

PANEL MOULDING SYSTEMS

RAYMOND EGG & DART

Product ID	H	P	L
PML02X00RA	2"	5/8"	94 1/2"



Product ID	H	W
PML10X10RA	10 1/4"	10 1/4"



Product ID	H	W
PML12X12RA	12 7/8"	12 7/8"



Product ID	H	W
PML08X08RA	8"	8"
PML10X10RA-2	10"	10"
PML12X12RA-2	12"	12"

OXFORD

Product ID	H	P	L
PML02X00OX	2"	5/8"	96"



Product ID	H	W
PML10X10OX	10"	10"



Product ID	H	W
PML14X04OX	4 1/4"	14 7/8"



Product ID	H	W
PML06X06OX	6"	6"
PML08X08OX	8 1/2"	8 1/2"
PML10X10OX-2	10"	10"
PML11X11OX	11 3/4"	11 3/4"
PML12X12OX-2	12"	12"

DEVON ROPE

Product ID	H	P	L
PML02X00DE	2"	7/8"	94 1/2"



Product ID	H	W
PML08X08DE	8"	8"
PML10X10DE	10"	10"



Product ID	H	W
PML09X09DE	9"	9"

PANEL MOULDING SYSTEMS



SUSSEX

Product ID	H	P	L
PML02X00SU	2"	1 7/8"	94 1/2"



Product ID	H	W
PML10X10SU	10 3/4"	10 3/4"



Product ID	H	W
PML06X06SU	6"	6"
PML08X08SU	8"	8"
PML10X10SU-2	10"	10"



Product ID	H	W
PML09X10SE	10"	9 5/8"



VALERIANO

Product ID	H	P	L
PML02X00VA	2"	3/4"	94 1/2"



Product ID	H	W
PML09X09VA	9 3/8"	9 3/8"



LOERA

Product ID	H	P	L
PML02X00LO	2 1/4"	3/4"	94 1/2"



Product ID	H	W
PML28X28LO	28"	28"

PANEL MOULDING SYSTEMS

FOSTER RUNNING COIN

Product ID	H	P	L
PML02X00FO	2 3/8"	3/4"	94 1/2"



Product ID	H	W
PML10X10FO	10 1/4"	10 1/4"



Product ID	H	W
PML10X10FO-2	10 1/4"	10 1/4"

POMPEII

Product ID	H	P	L
PML02X00PO	2 1/2"	3/4"	96"



Product ID	H	W
PML13X10PM-L	10 5/8"	13 1/4"



Product ID	H	W
PML13X10PM-R	10 5/8"	13 1/4"



Product ID	H	W
PML11X11PM	11 3/4"	11 3/4"



Product ID	H	W
PML08X08PO	8"	8"
PML10X10PO	10"	10"
PML10X10PM-2	10 1/2"	10 1/2"
PML12X12PO	12"	12"



Product ID	H	W
PML10X10PM	10 5/8"	10 5/8"



Beautiful. Simple. Miterless.

PANEL MOULDING SYSTEMS



ACANTHUS LEAF

Product ID	H	P	L
PML02X00AC	2 1/2"	1/2"	94 1/2"



Product ID	H	W
PML09X09AC	9 3/8"	9 3/8"



Product ID	H	W
PML10X10AC	10 7/8"	10 7/8"



BEDFORD

Product ID	H	P	L
PML02X01BE	2 5/8"	1 1/8"	94"



Product ID	H	W
PML15X15BE	15 1/8"	15 1/8"



Product ID	H	W
PML16X16BE	16 1/2"	16 1/2"



Product ID	H	W
PML19X19BE	19 5/8"	19 5/8"



Product ID	H	W
PML17X17BE	17 3/4"	17 3/4"



EDINBURGH

Product ID	H	P	L
PML03X01ED	3"	1 1/8"	94 1/4"



Product ID	H	W
PML14X14ED	14 3/8"	14 3/8"



Product ID	H	W
PML16X16ED	16 1/4"	16 1/4"

CAPUTO EGG & DART

Product ID	H	P	L
PML03X00CA	3 1/8"	3/4"	94 1/2"



Product ID	H	W
PML12X12CA	12"	12"
PML16X16CA	16 1/8"	16 1/8"



Product ID	H	W
PML19X19CA	19 7/8"	19 7/8"

EMERY

Product ID	H	P	L
PML03X00EM	3 1/8"	3/4"	94 1/2"



Product ID	H	W
PML10X10EM	10 5/8"	10 5/8"
PML12X12EM	12"	12"



Product ID	H	W
PML15X15EM	15 3/4"	15 3/4"

DUBLIN

Product ID	H	P	L
MLD04X01DU	4"	1 1/8"	96"



Product ID	H	W
PML11X11CH	11 3/4"	11 3/4"

PANEL MOULDING



PANEL MOULDING



STOCKPORT

Product ID	H	P	L
CHA01X00ST	3/4"	3/8"	96"



TRADITIONAL

Product ID	H	P	L
PML00X00TR	3/4"	3/8"	94"



EMERY

Product ID	H	P	L
CHA01X00EM	3/4"	3/8"	96"



CLASSIC

Product ID	H	P	L
PML00X00CL	7/8"	1/2"	96"



ODESSA

Product ID	H	P	L
PML00X00OD	7/8"	3/8"	94 1/2"



BRADFORD SMOOTH

Product ID	H	P	L
PML01X01BR	7/8"	1/2"	96"



ALEXANDRIA

Product ID	H	P	L
MLD01X00AL	1"	3/4"	94 1/2"



SYDNEY

Product ID	H	P	L
PML01X01SY	1"	1/2"	96"

**WE HAVE
FLEXIBLE
MOULDING.
JUST ASK!**

PANEL MOULDING



BULWARK

Product ID	H	P	L
MLD01X00BU	1"	5/8"	96"



CRENDON BEAD & BARREL

Product ID	H	P	L
MLD01X00CR	1"	5/8"	96"



VALERIANO

Product ID	H	P	L
MLD01X00VA	1"	1/4"	94 1/2"



MEDWAY

Product ID	H	P	L
PIR01X00ME	1"	1/2"	96"



CRENDON

Product ID	H	P	L
PML01X01CR	1 1/8"	3/8"	96"



KEPLER

Product ID	H	P	L
PML01X01KP	1 1/8"	1/2"	94 1/2"



EGG & DART

Product ID	H	P	L
MLD01X01EG	1 1/4"	3/8"	94 1/2"



MIDDLESBOROUGH EGG & DART

Product ID	H	P	L
PML01X00MD	1 1/4"	3/8"	94 1/2"



NEXUS

Product ID	H	P	L
PML01X00NE	1 1/4"	1/2"	94 1/2"



STOCKPORT

Product ID	H	P	L
PML01X00ST	1 1/4"	5/8"	96"

PANEL MOULDING

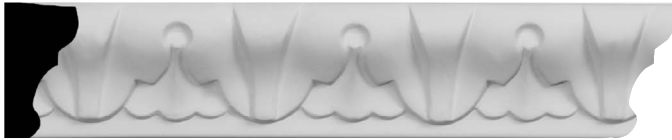

ACANTHUS LEAF

Product ID	H	P	L
MLD01X00AC	1 3/8"	7/8"	94 1/2"



DUBLIN

Product ID	H	P	L
PML01X01DU	1 3/8"	3/4"	94 1/2"



SWINDON

Product ID	H	P	L
CHA01X00SW	1 1/2"	1/2"	94 7/8"



FEDERAL

Product ID	H	P	L
CHA01X00FE	1 1/2"	1/2"	96"



VINCENT

Product ID	H	P	L
MLD01X00VI	1 1/2"	1/4"	94 1/2"



ABERDEEN

Product ID	H	P	L
PML01X00AB	1 1/2"	3/4"	94 1/4"



ASHFORD

Product ID	H	P	L
PML01X00AS	1 1/2"	1/2"	96"



SEVILLE

Product ID	H	P	L
PML01X00SE	1 1/2"	3/4"	96"



ERIS

Product ID	H	P	L
PML01X00ER	1 5/8"	3/4"	94 1/2"



JACKSON FRENCH RIBBON

Product ID	H	P	L
PML01X00JA	1 5/8"	3/4"	94 1/2"

PANEL MOULDING



VALERIANO

Product ID	H	P	L
PML02X01VA	1 5/8"	1"	96"



KENDALL

Product ID	H	P	L
PML01X00KD	1 5/8"	3/4"	96"



SOFIA

Product ID	H	P	L
CHA01X00SO	1 3/4"	1/2"	96"



SWINDON

Product ID	H	P	L
PML01X00SW	1 5/8"	1/2"	94 1/2"



BACKPLATE

Product ID	H	P	L
PIR01X00BP	1 3/4"	1/2"	96"



MEDWAY

Product ID	H	P	L
PIR02X00ME	1 3/4"	1/2"	96"



CLAREMONT

Product ID	H	P	L
PML01X00CL	1 3/4"	1/2"	96"



LANARKSHIRE

Product ID	H	P	L
PML01X00LA	1 3/4"	5/8"	94 1/2"



TIRANA

Product ID	H	P	L
PML01X00TI	1 3/4"	3/4"	96"



REEDED ACANTHUS LEAF

Product ID	H	P	L
PML01X01AC	1 3/4"	1 1/8"	94 1/2"

PANEL MOULDING



HILLSBOROUGH

Product ID	H	P	L
PML01X01HI	1 3/4"	5/8"	94 1/2"



SELLEK

Product ID	H	P	L
PML01X01SK	1 3/4"	1"	94 1/2"



CLASSIC BARREL

Product ID	H	P	L
PML02X01CL	1 3/4"	7/8"	96"



QUEENSTOWN

Product ID	H	P	L
CHA02X01QU	1 7/8"	1 3/8"	96"

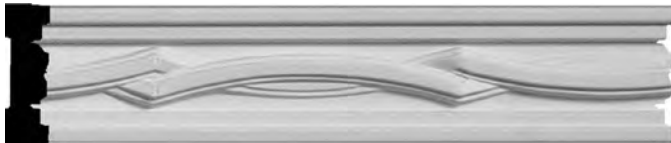

COLE

Product ID	H	P	L
CHA01X00CO	1 7/8"	1/2"	96"



BLACKTHORNE

Product ID	H	P	L
MLD01X00BL	1 7/8"	3/4"	96"



ARTIS

Product ID	H	P	L
PML01X00AR	1 7/8"	3/4"	94 1/2"



CRENDON

Product ID	H	P	L
PML01X00CR	1 7/8"	7/8"	94 1/2"



EGG & DART CLASSIC

Product ID	H	P	L
PML02X01EG	1 7/8"	5/8"	96"



ALEXANDRIA

Product ID	H	P	L
CAS02X00AL	2"	1/2"	96"

PANEL MOULDING

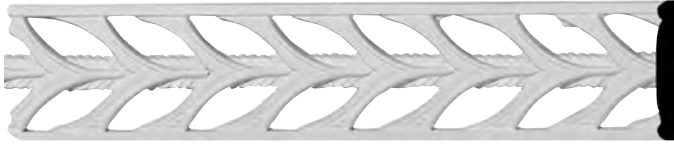

MONIQUE

Product ID	H	P	L
PIR02X00MO	2"	1/4"	96"



BAROQUE

Product ID	H	P	L
MLD02X01BQ	2"	3/4"	94 1/2"



SIMPLE LEAF

Product ID	H	P	L
MLD02X01LE	2"	5/8"	94 1/2"

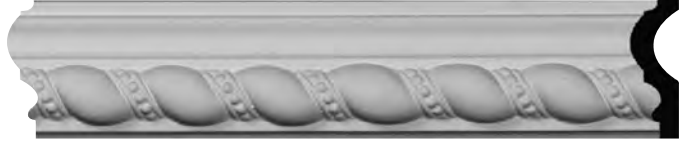

DEVON ROPE

Product ID	H	P	L
PML02X00DE	2"	7/8"	94 1/2"



MILTON

Product ID	H	P	L
PML02X00MI	2"	3/4"	94 1/2"

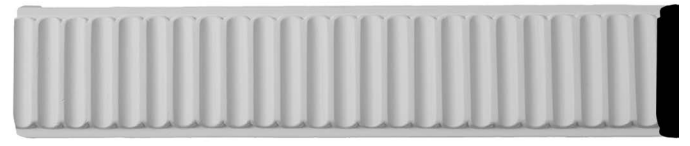

NEVIO

Product ID	H	P	L
PML02X00NE	2"	3/8"	94 1/2"



OXFORD

Product ID	H	P	L
PML02X00OX	2"	5/8"	94 1/2"



SUSSEX

Product ID	H	P	L
PML02X00SU	2"	1 7/8"	94 1/2"



RAYMOND EGG & DART

Product ID	H	P	L
PML02X00RA	2"	5/8"	94 1/2"



VALERIANO

Product ID	H	P	L
PML02X00VA	2"	3/4"	94 1/2"

PANEL MOULDING



MARSEILLE FRENCH SCROLL

Product ID	H	P	L
MLD02X00MA	2 1/8"	3/8"	94 1/2"



KENT

Product ID	H	P	L
MLD02X00KE	2 1/8"	5/8"	94 1/2"



EMERY

Product ID	H	P	L
PML02X01EM	2 1/8"	7/8"	94 1/2"



NADIA

Product ID	H	P	L
PML02X01NA	2 1/8"	1 1/8"	96 1/8"

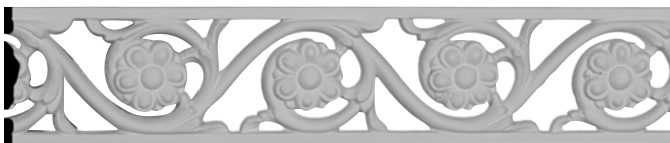

DELFINA

Product ID	H	P	L
PML02X01DL	2 1/8"	3/8"	79"



RIBBON

Product ID	H	P	L
PML02X01RI	2 1/8"	1/4"	78 7/8"

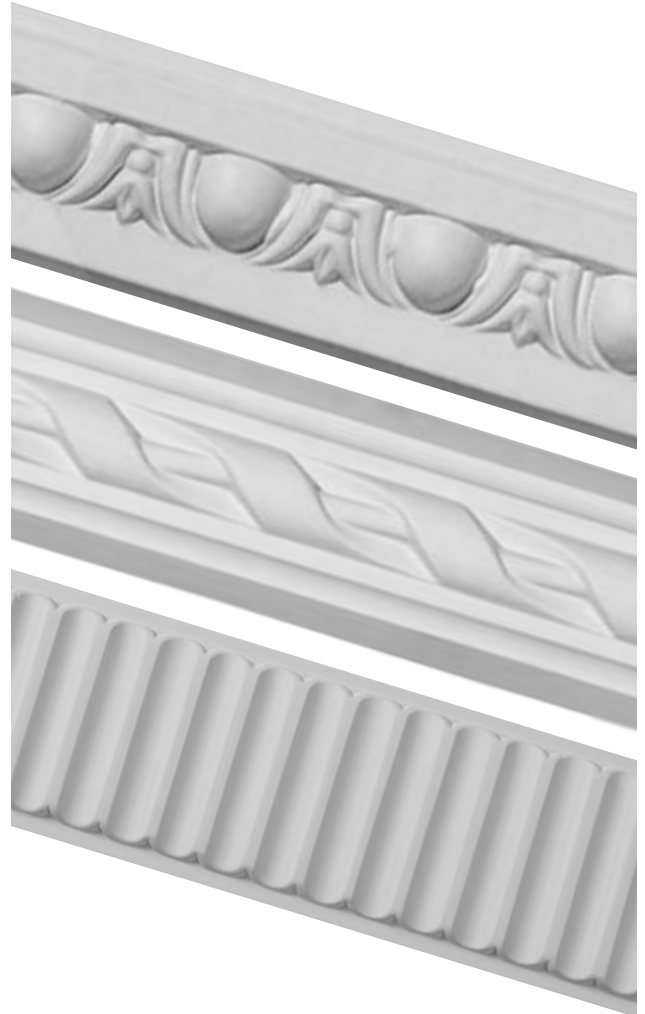

LOERA

Product ID	H	P	L
PML02X00LO	2 1/4"	3/4"	94 1/2"

PANEL MOULDING



DERRY PIERCED

Product ID	H	P	L
PIR02X00DE	2 1/4"	3/8"	78"



SALEM

Product ID	H	P	L
MLD02X00SA	2 1/4"	1/4"	94 1/2"



PEARL PIERCED

Product ID	H	P	L
PIR02X00PE	2 1/4"	3/8"	78"



PEARL

Product ID	H	P	L
PML02X00PE	2 3/8"	3/8"	79 1/2"



SHELL

Product ID	H	P	L
PML02X01SH	2 3/8"	1 1/8"	96 1/8"



ALEXANDRIA

Product ID	H	P	L
MLD02X00AL	2 3/8"	3/8"	94 1/2"



CARRILLO

Product ID	H	P	L
CHA02X01CI	2 3/8"	5/8"	96"



HAMILTON

Product ID	H	P	L
PML02X01HA	2 3/8"	1"	94 1/2"



FOSTER

Product ID	H	P	L
PML02X00FO	2 3/8"	3/4"	94 1/2"



WHITMAN

Product ID	H	P	L
PML02X01WH	2 3/8"	1 1/4"	96 1/8"

PANEL MOULDING



BULWARK

Product ID	H	P	L
MLD02X00BU	2 1/2"	3/8"	94 1/2"



BEAD & BARREL

Product ID	H	P	L
MLD02X01BE	2 1/2"	1"	94 1/2"



NORWICH

Product ID	H	P	L
PML03X01CL	2 1/2"	7/8"	94 1/2"



SWINDON

Product ID	H	P	L
MLD02X01SW	2 1/2"	1 1/8"	94 1/2"



EDWARD

Product ID	H	P	L
CHA02X00ED	2 1/2"	1/2"	96"



BEDFORD

Product ID	H	P	L
CAS02X00BE	2 1/2"	1/2"	96"



POMPEII

Product ID	H	P	L
PML02X00AC	2 1/2"	1/2"	94 1/2"



CLASSIC

Product ID	H	P	L
PML02X00PO	2 1/2"	3/4"	96"



BEDFORD

Product ID	H	P	L
MLD02X00BE	2 5/8"	7/8"	94 1/2"



ACANTHUS LEAF

Product ID	H	P	L
PML02X01BE	2 5/8"	1 1/8"	94"

PANEL MOULDING



ALEXANDRIA ROPED

Product ID	H	P	L
PML03X01AL	2 5/8"	3/4"	96"



BEADED

Product ID	H	P	L
MLD02X00NO	2 5/8"	3/4"	94 1/2"



TRALEE

Product ID	H	P	L
CHA02X00TR	2 3/4"	1/2"	96"



JACKSON PIERCED

Product ID	H	P	L
PIR02X00JA	2 3/4"	3/8"	78"



ERIS

Product ID	H	P	L
MLD02X00ER	2 3/4"	3/8"	96"



CRENDON

Product ID	H	P	L
CHA02X00CR	2 3/4"	7/8"	96"



TIRANA

Product ID	H	P	L
MLD02X00TI	2 3/4"	5/8"	94 1/2"



EDWARDS

Product ID	H	P	L
MLD02X01ED	2 3/4"	1"	96"



HILLSBOROUGH PIERCED

Product ID	H	P	L
PIR02X00HI	2 3/4"	3/8"	78"



CLASSIC

Product ID	H	P	L
PML03X02CL	2 3/4"	1 3/8"	96"

PANEL MOULDING



SMOOTH

Product ID	H	P	L
PML03X01SM	2 7/8"	5/8"	96"



NESTOR

Product ID	H	P	L
PML03X01NE	2 7/8"	7/8"	96 1/8"



DIANA ROPE

Product ID	H	P	L
MLD03X00DI	3"	5/8"	94 1/2"



LYON FLUTED

Product ID	H	P	L
CHA03X01LY	3"	5/8"	94 1/2"



DUBLIN

Product ID	H	P	L
MLD03X01DU	3"	1 1/8"	96"



NEVIO

Product ID	H	P	L
CHA03X00NE	3"	5/8"	96"



HOLMDEL

Product ID	H	P	L
PIR03X00HO	3"	3/8"	96"

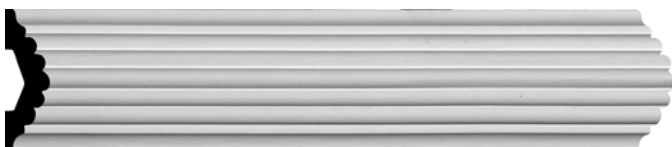

REDED

Product ID	H	P	L
PML03X01RE	3"	1 1/8"	96 1/8"

LOOKING FOR A
PANEL MOULDING
 LIKE NO OTHER?
 TRY OUR **PIERCED**
PANEL MOULDING!

PANEL MOULDING



WOODRUFF

Product ID	H	P	L
MLD03X01WF	3"	5/8"	94 1/2"



EDINBURGH

Product ID	H	P	L
PML03X01ED	3"	1 1/8"	94 1/4"



OSLO ROPE

Product ID	H	P	L
PML03X01OS	3"	1"	94 1/2"

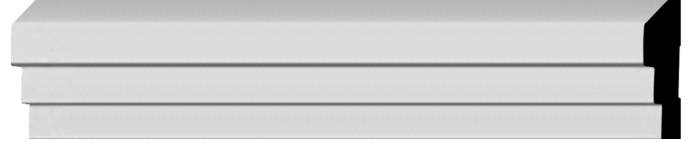

STANDARD

Product ID	H	P	L
PML03X01ST	3"	7/8"	96 1/8"



HEATON

Product ID	H	P	L
PML03X01HE	3"	1"	96"



HAMILTON

Product ID	H	P	L
PIR03X00HA	3"	3/8"	96"



LEAF

Product ID	H	P	L
CHA03X01LE	3"	7/8"	96"



ERIS

Product ID	H	P	L
CHA03X01ER	3 1/8"	7/8"	96"



FEDERAL

Product ID	H	P	L
CHA03X00FE	3 1/8"	3/4"	96"



CAPUTO

Product ID	H	P	L
CHA03X00CA	3 1/8"	7/8"	96"

PANEL MOULDING



MARIA

Product ID	H	P	L
MLD03X00MA	3 1/8"	3/4"	96"



FEDERAL

Product ID	H	P	L
CHA03X02FE	3 1/8"	1"	94 1/2"



FEDERAL

Product ID	H	P	L
CHA03X01FE	3 1/8"	1"	94 1/2"



WINDSOR DENTIL

Product ID	H	P	L
CHA03X00WI	3 1/8"	7/8"	96"



BACKPLATE

Product ID	H	P	L
PIR03X00BP	3 1/8"	5/8"	96"



EMERY

Product ID	H	P	L
MLD03X00EM	3 1/8"	1/2"	94 1/2"



MONIQUE

Product ID	H	P	L
PIR03X00MO	3 1/8"	5/8"	96"



EMERY

Product ID	H	P	L
PML03X00EM	3 1/8"	3/4"	94 1/2"



CAPUTO EGG & DART

Product ID	H	P	L
PML03X00CA	3 1/8"	3/4"	94 1/2"



EMERY

Product ID	H	P	L
PML03X00ER	3 1/8"	3/4"	94 1/2"

PANEL MOULDING



BEADED

Product ID	H	P	L
PML03X02BE	3 1/8"	1 1/4"	96 1/8"



SWINDON

Product ID	H	P	L
PML03X01SW	3 1/8"	1/2"	96"

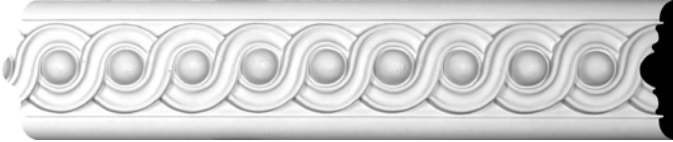

FOSTER

Product ID	H	P	L
PML03X01FO	3 1/4"	7/8"	96 1/8"



DELFINA

Product ID	H	P	L
CHA03X00DL	3 1/4"	3/4"	96"



VICEROY

Product ID	H	P	L
PML03X01VI	3 1/4"	1 1/8"	96 1/8"



ROSE

Product ID	H	P	L
CHA03X01RO	3 1/4"	3/4"	94 1/2"



EGG AND DART

Product ID	H	P	L
PML03X01EG	3 1/4"	1"	96 1/8"



COLE

Product ID	H	P	L
MLD03X00CO	3 1/4"	5/8"	94 1/2"



KINSLEY PIERCED

Product ID	H	P	L
PML03X00KI	3 1/4"	3/8"	96"



CHESTERFIELD

Product ID	H	P	L
PML03X01CH	3 3/8"	1"	94 1/2"



MEDWAY

Product ID	H	P	L
CHA03X00ME	3 3/8"	3/4"	96"



TRADITIONAL

Product ID	H	P	L
PML03X02TR	3 3/8"	1 5/8"	94 1/2"



ERIS ORIGINAL KEY

Product ID	H	P	L
MLD03X00ER	3 1/2"	1/2"	96"



ATTICA

Product ID	H	P	L
CHA03X00AT	3 1/2"	3/4"	96"



FAIRFAX

Product ID	H	P	L
PML03X01FA	3 1/2"	1 1/8"	96"

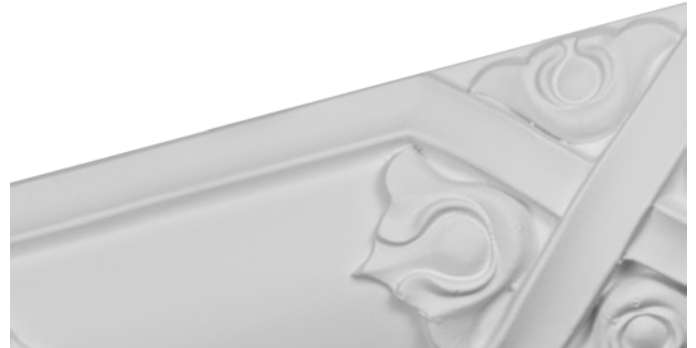
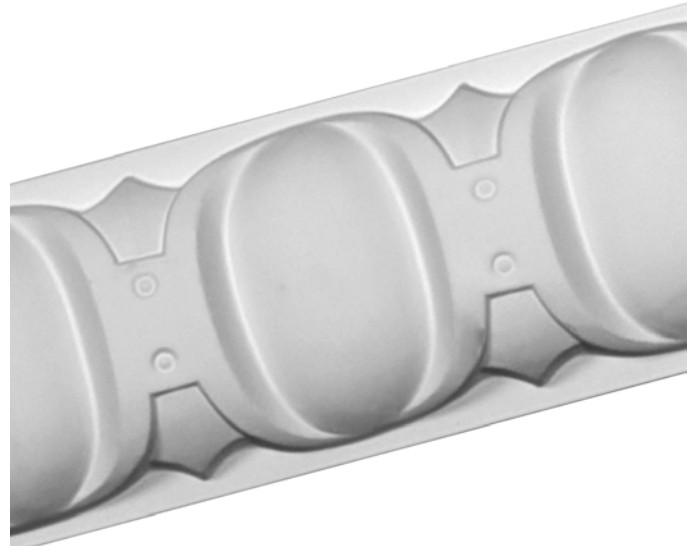

PANEL MOULDING



DIANE LEAF & RIBBON

Product ID	H	P	L
CHA03X00DI	3 1/2"	3/4"	96"



BENSON

Product ID	H	P	L
MLD03X01BE	3 1/2"	1 1/2"	96"



RIBBON

Product ID	H	P	L
PML04X02RE	3 1/2"	2 3/8"	96"



MUNICH DENTIL

Product ID	H	P	L
MLD03X01MU	3 1/2"	1"	96"



HOLMDEL

Product ID	H	P	L
PML03X00HO	3 1/2"	3/4"	96"

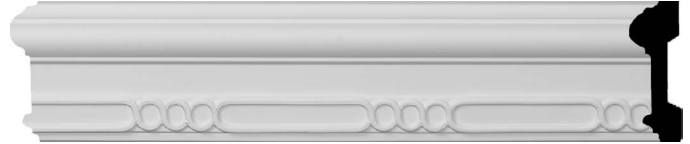

DOVER

Product ID	H	P	L
CAS03X01DR	3 1/2"	1 3/8"	96"



BEDFORD

Product ID	H	P	L
PML03X01BE	3 1/2"	1 1/8"	94 1/2"



ODESSA

Product ID	H	P	L
MLD03X01OD	3 1/2"	1"	96"

ROOTED IN
HISTORY &
TRADITION



BLACKTHORN

Product ID	H	P	L
PML03X01BL	3 1/2"	1"	96 1/8"

PANEL MOULDING



NEVIO

Product ID	H	P	L
CHA03X01NE	3 5/8"	1/2"	95 3/4"



CLASSIC

Product ID	H	P	L
CAS04X94X01	3 3/4"	7/8"	94 1/2"



LINUS

Product ID	H	P	L
CHA03X01LI	3 5/8"	1"	96"



DUBLIN

Product ID	H	P	L
CAS03X01DU	3 5/8"	1 1/4"	96"



CLASSIC

Product ID	H	P	L
PML03X00CL	3 5/8"	3/4"	96"



LUNEL

Product ID	H	P	L
PML03X00LU	3 7/8"	1/2"	96"



RUNNING ROSE

Product ID	H	P	L
CHA03X00RO	3 7/8"	3/4"	96"



FAIRFAX PIERCED

Product ID	H	P	L
PIR03X00FA	3 7/8"	3/8"	96"



PALMETTO

Product ID	H	P	L
PML04X02PA	3 7/8"	2 3/8"	96"



MARCELLA

Product ID	H	P	L
CHA03X00MA	3 7/8"	3/4"	96"

PANEL MOULDING

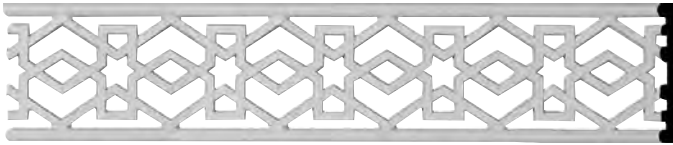

SWINDON

Product ID	H	P	L
PIR04X00SW	4"	3/8"	96"

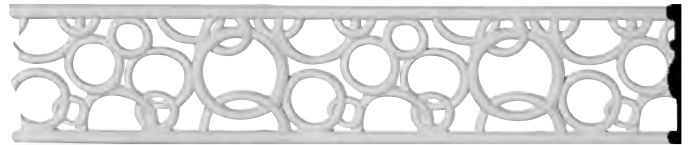

TOMANGO PIERCED

Product ID	H	P	L
PIR04X00TO	4"	3/8"	96"



SYDNEY

Product ID	H	P	L
MLD04X01SY	4"	5/8"	94 1/2"



EDWARDS

Product ID	H	P	L
PML04X00ED	4"	7/8"	94 1/2"



DYLAN SPRING

Product ID	H	P	L
CHA04X01DY	4"	1 1/8"	96"



GORLEEN

Product ID	H	P	L
PML04X00GO	4"	3/4"	96"



OSLO

Product ID	H	P	L
MLD04X00OS	4"	3/4"	96"



DUBLIN

Product ID	H	P	L
PML04X01DU	4"	1 1/4"	94 1/2"



VERSAILLES FLOWER BLOSSOM

Product ID	H	P	L
CHA04X01VE	4"	1"	96"



DYLAN

Product ID	H	P	L
CAS04X01DY	4"	1 1/2"	96"



DUBLIN

Product ID	H	P	L
MLD04X01DU	4"	1 1/8"	96"



SMOOTH CLASSIC

Product ID	H	P	L
PML04X01CL	4 1/8"	5/8"	96"



SMOOTH CLASSIC

Product ID	H	P	L
PML04X01CL	4 1/8"	5/8"	96"



SEQUENTIAL

Product ID	H	P	L
CHA04X01SQ	4 1/8"	1 1/8"	96"



SMALL SWAG

Product ID	H	P	L
PML04X01SW	4 1/4"	1 1/4"	96"



NESTOR

Product ID	H	P	L
CHA04X00NS	4 1/4"	5/8"	96"



CLAREMONT

Product ID	H	P	L
CHA04X01CL	4 1/4"	1 5/8"	96"



ROPE

Product ID	H	P	L
CHA04X01RO	4 1/4"	1 1/2"	94 1/8"

**MITER FREE
SOLUTIONS
USING OUR
PANEL MOULDING
SYSTEMS!
SEE PAGE 202**

PANEL MOULDING



EMERY

Product ID	H	P	L
PML04X01EM	4 1/4"	5/8"	96 1/8"



FEDERAL

Product ID	H	P	L
CHA04X01FE	4 3/8"	7/8"	96"



FLORAL

Product ID	H	P	L
CHA04X00FL	4 1/4"	3/4"	96"



DENTIL

Product ID	H	P	L
MLD04X01DE	4 3/8"	2 3/8"	96 1/4"



FEDERAL

Product ID	H	P	L
PML04X01FE	4 3/8"	7/8"	96 1/8"



TRISTAN

Product ID	H	P	L
CHA04X01TN	4 1/2"	1 1/2"	94 3/8"



WOODRUFF

Product ID	H	P	L
PML04X01WF	4 1/2"	7/8"	96 1/8"



HOLMDEL

Product ID	H	P	L
CHA05X02HO	4 3/4"	1 3/4"	94 1/2"

**WALL & PICTURE
FRAME PANELLING
ON PAGE 251.**



FLORAL

Product ID	H	P	L
CHA04X00FL	4 1/4"	3/4"	96"

PANEL MOULDING



LYON FLUTED

Product ID	H	P	L
PML04X01LY	4 3/4"	1"	96"



DIANE

Product ID	H	P	L
PML04X01DI	4 3/4"	1 1/8"	94 1/2"



SEVILLE

Product ID	H	P	L
MLD04X01SE	4 3/4"	1 3/8"	94 1/2"



LISBON

Product ID	H	P	L
CHA04X00LI	4 3/4"	7/8"	96"



EL SINORE

Product ID	H	P	L
CAS04X00EL	4 7/8"	1 5/8"	96"



SHEFFIELD

Product ID	H	P	L
CHA04X00SH	4 7/8"	7/8"	96"



BRONTES

Product ID	H	P	L
MLD05X01BO	5"	1 3/8"	96"



ABERDEEN

Product ID	H	P	L
MLD05X00AB	5"	5/8"	96"



STANDARD

Product ID	H	P	L
MLD05X04ST	5"	4"	94 1/2"



WAKEFIELD

Product ID	H	P	L
MLD05X00WA	5"	5/8"	96"

PANEL MOULDING



ANTONIO

Product ID	H	P	L
CHA05X01AN	5"	5/8"	96"



DUBLIN

Product ID	H	P	L
MLD05X01DU	5"	1 5/8"	96"



ORLEANS ROPE

Product ID	H	P	L
MLD05X000L	5"	7/8"	94 5/8"



VERSAILLES FLORAL LEAF

Product ID	H	P	L
MLD05X00VE	5 1/8"	7/8"	94 1/2"



BEDFORD

Product ID	H	P	L
MLD05X01BE	5 1/8"	1 1/8"	94 1/2"



EMERY

Product ID	H	P	L
MLD05X01EM	5 1/8"	1 1/8"	94 1/2"



STANDARD

Product ID	H	P	L
MLD06X03ST	5 1/2"	2 3/4"	94 1/2"



STANDARD PANEL

Product ID	H	P	L
PML06X02PN-3	5 1/2"	2"	94 1/2"



BLACKTHORNE

Product ID	H	P	L
PML05X01BL	5 1/2"	1 1/4"	94 1/2"

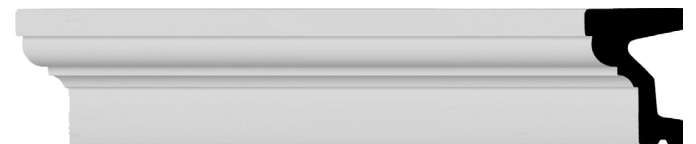

STANDARD

Product ID	H	P	L
MLD06X04ST-2	5 1/2"	4"	94 1/2"



FLORAL

Product ID	H	P	L
MLD06X01FL	5 1/2"	1 3/8"	94 1/2"



LEGACY

Product ID	H	P	L
PML04X00LE	5 1/2"	3/4"	96"



SEVILLE SMOOTH

Product ID	H	P	L
MLD05X02X08SE	5 1/2"	2"	96"

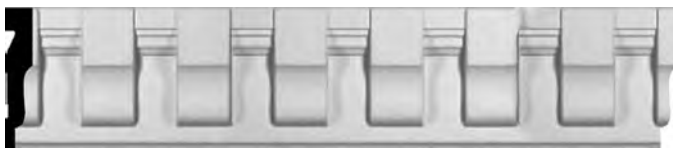

CHESTERFIELD

Product ID	H	P	L
CHA05X01CH	5 5/8"	1 1/4"	96"



LARGE SWINDON

Product ID	H	P	L
PML06X01SW	5 7/8"	7/8"	96"



ADD BEAUTY TO YOUR HOME



PANEL MOULDING



KINSLEY

Product ID	H	P	L
PML06X01KI	6"	1 1/8"	94 1/2"



STANDARD PANEL

Product ID	H	P	L
PML06X02PN-2	6"	1 5/8"	94 1/2"



STANDARD PANEL

Product ID	H	P	L
PML06X02PN-1	6 1/8"	2"	94 1/2"

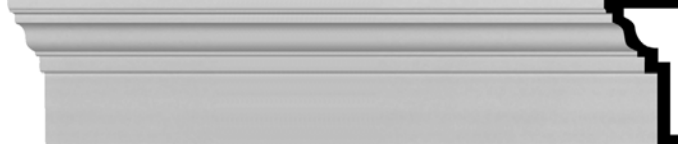

TRADITIONAL FASCIA

Product ID	H	P	L
CRHM06X96	6"	2 3/4"	96"



ODESSA

Product ID	H	P	L
CHA06X01OD	6 1/4"	1 1/2"	94 1/2"



FEDERAL

Product ID	H	P	L
MLD06X02FE	6 1/4"	2"	94 1/2"



STANDARD

Product ID	H	P	L
MLD06X04ST-1	6 1/4"	4"	94 1/2"



SPRINGTIME

Product ID	H	P	L
CHA06X00SP	6 3/4"	3/4"	96"



PANEL MOULDING



TYRONE SCROLL & FLOWERS

Product ID	H	P	L
MLD07X01TY	7"	1"	96"



ASHFORD

Product ID	H	P	L
MLD07X01AS	7"	1"	96"



ELSINORE

Product ID	H	P	L
MLD07X01EL	7"	1"	96"



WELLINGTON

Product ID	H	P	L
MLD07X01WE	7"	1"	96"



GRAPE

Product ID	H	P	L
PIR07X00GR	7"	5/8"	96"



MONIQUE

Product ID	H	P	L
MLD07X01MO	7"	1"	96"



DENTIL

Product ID	H	P	L
PML07X02DE	7"	1 5/8"	94 1/2"



FLOWER PIERCED

Product ID	H	P	L
PML07X01FL	7"	5/8"	94 1/2"



PANEL MOULDING



EMERY

Product ID	H	P	L
CHA07X01ER	7 1/2"	1 3/4"	96"



TRADITIONAL FASCIA

Product ID	H	P	L
CRHM07X96	7 1/4"	2 3/4"	96"



ALEXA

Product ID	H	P	L
PML07X02AX	7 1/2"	1 3/4"	95 5/8"



HARRINGTON URN

Product ID	H	P	L
CHA07X01HA	7 1/2"	1 3/4"	96"



FEDERAL

Product ID	H	P	L
CHA07X01UR	7 1/2"	1 3/4"	96"



ODESSA

Product ID	H	P	L
PML07X01OD	7 3/4"	1 1/8"	96"



EMERY

Product ID	H	P	L
MLD07X01EM	7 3/4"	1 3/8"	96"



BRADFORD

Product ID	H	P	L
MLD07X01BR	7 7/8"	1 7/8"	94 1/2"

ORANTE & INTRICATE



ALEXA

Product ID	H	P	L
MLD07X01AX	7 7/8"	1 3/8"	96"

PANEL MOULDING



TEMPLE

Product ID	H	P	L
MLD07X01TE	7 7/8"	1 3/8"	96"



LARGE DUBLIN

Product ID	H	P	L
PML08X01DU	8 1/4"	1 1/2"	94 1/2"



BEDFORD

Product ID	H	P	L
PML08X02BE	8 5/8"	2 1/2"	94 1/2"

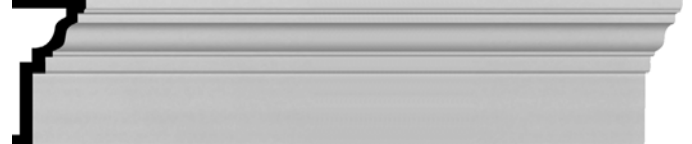

TRADITIONAL FASCIA

Product ID	H	P	L
CRHM09X96	9"	4 1/4"	96"



WAKEFIELD

Product ID	H	P	L
PML09X02WA	9 3/8"	1 3/4"	94 1/2"



DENTIL

Product ID	H	P	L
PML09X03DE	9 3/8"	3 1/8"	94 1/2"



VERTICAL HAMILTON

Product ID	H	P	L
PML10X02HM	9 7/8"	1 5/8"	96"



BEDFORD WITH FLOWERS

Product ID	H	P	L
MLD11X02BE	11 1/4"	1 7/8"	96"



TRADITIONAL FASCIA

Product ID	H	P	L
CRHM12X96	12"	5"	96"



STANDARD

Product ID	H	P	L
PML13X04ST	12 7/8"	3 5/8"	95 3/4"

CASING

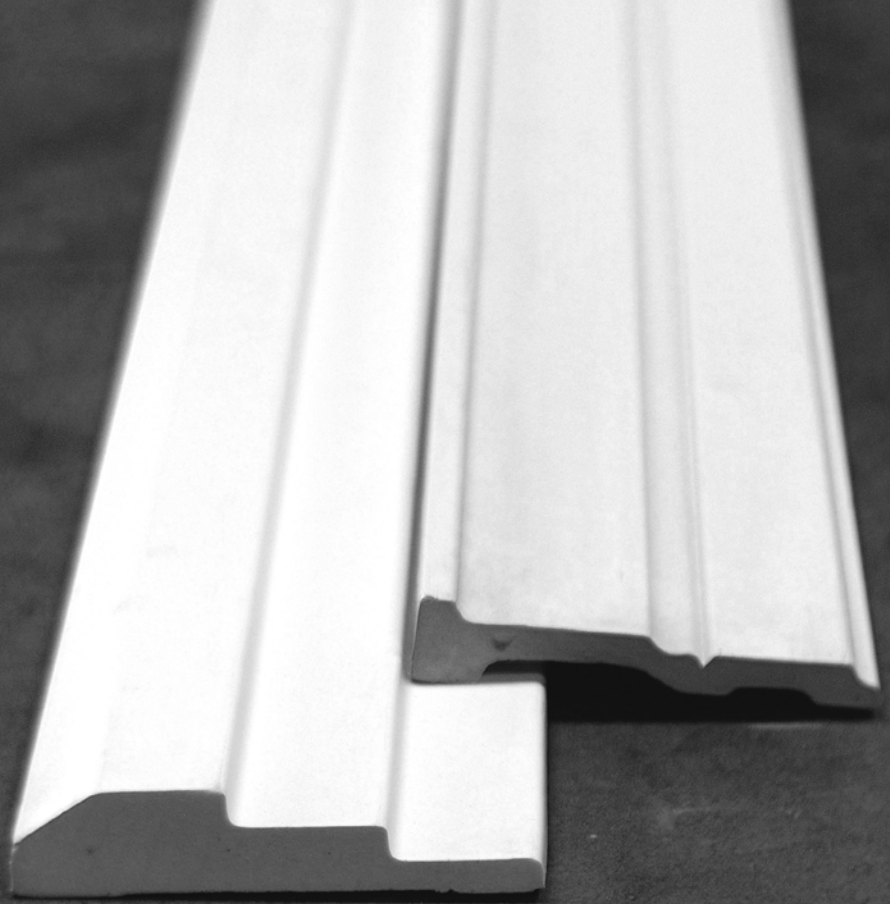

EDWARDS



EDWARDS TRADITIONAL

Product ID	H	P	L
CAS09X02ED	9 1/8"	2 1/4"	97 1/4"



EDWARDS SHELL

Product ID	H	P	L
CAS10X03ED	9 5/8"	2 3/4"	96 1/2"



EDWARDS FLOWER

Product ID	H	P	L
CAS11X02ED	6 3/8"	2 1/4"	96 1/4"

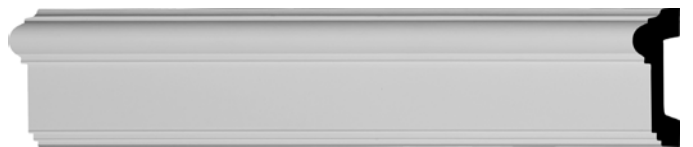

EDWARDS

Product ID	H	P	L
CAS04X01ED	3 3/4"	1 1/4"	96 1/4"

BRADFORD



BRADFORD TRADITIONAL

Product ID	H	P	L
CAS04X02BR	5"	1 1/2"	96 5/8"



BRADFORD FLOWER

Product ID	H	P	L
CAS05X01BR	5 1/4"	1 3/8"	96 5/8"

BRADFORD SHELL

Product ID	H	P	L
CAS05X02BR	4 7/8"	1 3/4"	96 5/8"

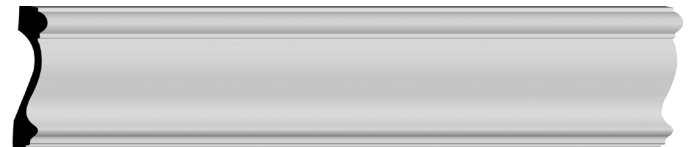

BRADFORD

Product ID	H	P	L
CAS04X01BR	4 7/8"	1"	96 1/8"

ASHFORD



ASHFORD TRADITIONAL

Product ID	H	P	L
CAS05X02AS	5 7/8"	1 3/4"	96 5/8"



ASHFORD FLOWER

Product ID	H	P	L
CAS07X02AS	6 3/4"	1 7/8"	96 5/8"



ASHFORD SHELL

Product ID	H	P	L
CAS06X02AS	6"	2 1/2"	96 5/8"



ASHFORD

Product ID	H	P	L
CAS06X01AS	6 3/8"	1 3/8"	96 1/8"

CASING



LISBON

Product ID	H	P	L
CHA02X00LI	2"	3/8"	96"



MONIQUE

Product ID	H	P	L
CAS02X00MO	2 7/8"	3/4"	96"



FLAT TRIM

Product ID	H	P	L
FLT03X01X96	3 1/4"	1"	96"



DEVON

Product ID	H	P	L
CAS03X01DE	3 1/2"	1 1/8"	96"



FELIX

Product ID	H	P	L
CAS04X00FE	4"	3/4"	96"



FLUTED

Product ID	H	P	L
MLD04X00FT	4"	3/8"	94 1/2"



LISBON

Product ID	H	P	L
PML04X00LI	4 1/2"	3/4"	96"



MARSEILLE FLUTED

Product ID	H	P	L
PML04X01MA	4 3/4"	1"	94 1/2"



FLUTED

Product ID	H	P	L
CAS05X79X01	5 1/8"	5/8"	78 3/4"



MILTON

Product ID	H	P	L
CAS05X01MI	5 1/4"	1"	96"

FLUTED AND REEDED CASING CAN BE USED AS PILASTERS!



FLAT TRIM

Product ID	H	P	L
FLT07X01X0FL	6 7/8"	1 3/8"	96"



FLUTED

Product ID	H	P	L
CAS07X79X01	7"	1"	78 3/4"



FLAT TRIM

Product ID	H	P	L
FLT07X00TR	7 1/2"	3/4"	78 3/4"



FLUTED

Product ID	H	P	L
CAS08X94X01	7 7/8"	1 1/8"	94 1/2"



REEDED

Product ID	H	P	L
CAS10X79X01	9 1/2"	1 3/8"	78 3/4"



FLUTED

Product ID	H	P	L
CAS13X79X01	12 5/8"	1 1/8"	78 3/4"



VICTORIAN

Product ID	H	P	L
CAS15X79X02	15"	1 7/8"	78 3/4"



REEDED

Product ID	H	P	L
CAS18X94X02	17 3/4"	1 1/2"	94 1/2"

BASEBOARDS



ABERDEEN

Product ID	H	P	L
BBD03X00AB	3 3/4"	1/2"	96"



ASHFORD

Product ID	H	P	L
BBD03X00AS	3 7/8"	1/2"	96"



BARCELONA

Product ID	H	P	L
BBD03X00BA	3 7/8"	1/2"	94 1/2"



SUSSEX

Product ID	H	P	L
BBD04X00SU	4"	5/8"	96"



HOLMDEL

Product ID	H	P	L
BBD03X00HO	3 7/8"	5/8"	94 1/2"



BARCELONA

Product ID	H	P	L
BBD04X00BA	4 3/4"	1/2"	94 1/2"



OSLO ROPE

Product ID	H	P	L
BBD04X01OS	4 1/2"	5/8"	96"



CLASSIC

Product ID	H	P	L
BBD05X01CL	5"	3/4"	94 1/2"



BRADFORD

Product ID	H	P	L
BBD04X00BR	4 3/4"	1/2"	96"



OSLO ROPE

Product ID	H	P	L
BBD06X01OS	6"	5/8"	96"



BRADFORD

Product ID	H	P	L
BBD05X00BR	5 7/8"	5/8"	96"



ABERDEEN

Product ID	H	P	L
BBD05X00AB	5 1/2"	5/8"	96"



WAINSCOTING FOR LESS

Use panel moulding to create the elegant look of wainscoting without the price.

HERE IS WHAT YOU CAN DO:

- Use a chair rail as the top moulding.
- Use any moulding you desire (we suggest a simpler style) to make the panels.
- Use a baseboard for the bottom moulding.
- Paint the wall white in-between all of the moulding.
- It's that easy!

PICTURE FRAME MOULDING



LEGACY PANEL

#	PRODUCT	H	P	W
1.	PNL22X05LE	22 5/8"	5/8"	4 3/4"
2.	PNL22X09LE	21 5/8"	5/8"	8 5/8"
3.	PNL22X22LE	21 5/8"	5/8"	21 5/8"
4.	PNL22X30LE-1	29 3/4"	5/8"	21 5/8"
5.	PNL22X36LE-1	35 5/8"	5/8"	21 5/8"
6.	PNL22X36LE-2	36 3/8"	5/8"	21 5/8"



EXAMPLE APPLICATIONS

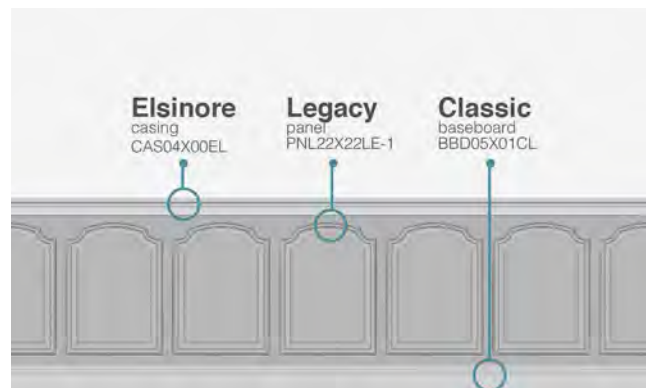
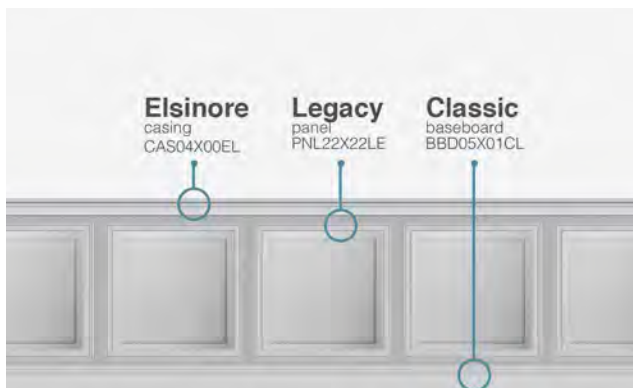
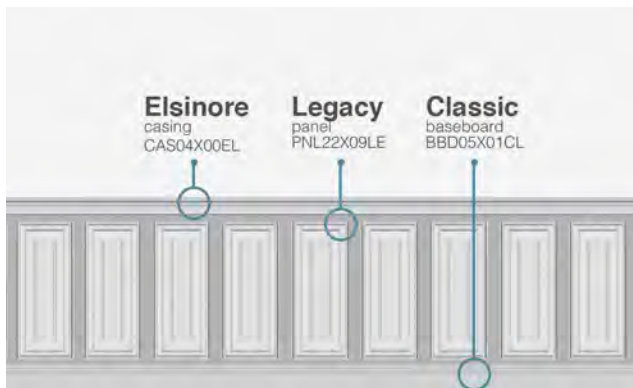

PICTURE FRAME PANEL

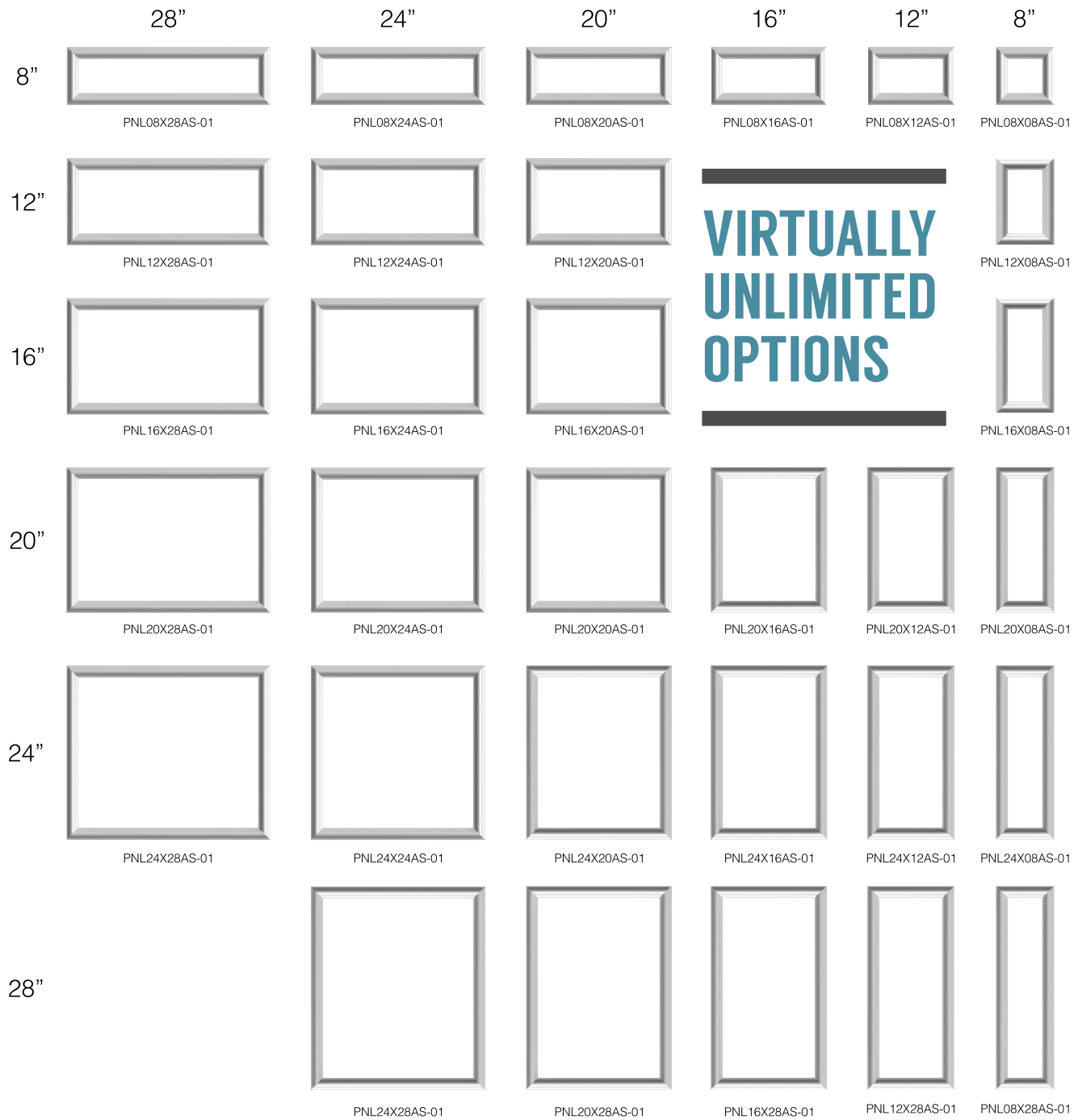

**MATCH PICTURE FRAME
PANELS OR CREATE CUSTOM
SIZES & STYLES WITH THE
ASHFORD PANEL MOULDING.**

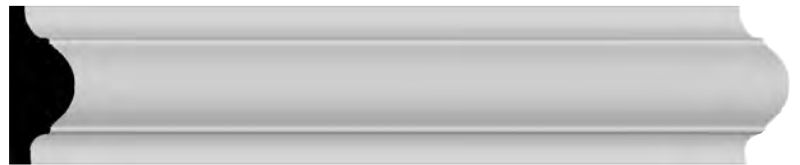

ASHFORD

Product ID

PML01X00AS

H

1 1/2"

P

1/2"

L

96"

PICTURE FRAME PANEL

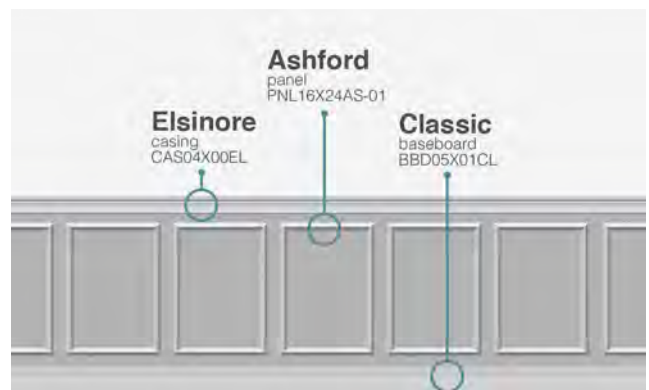
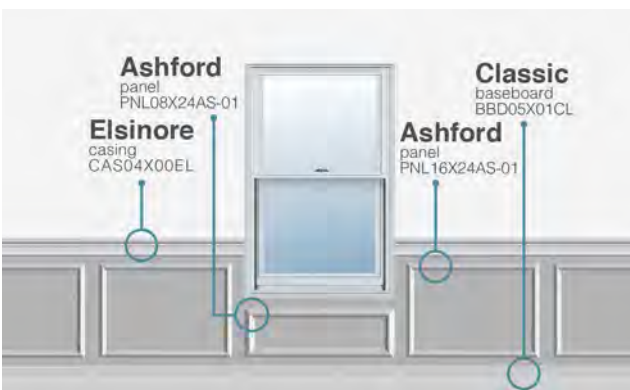
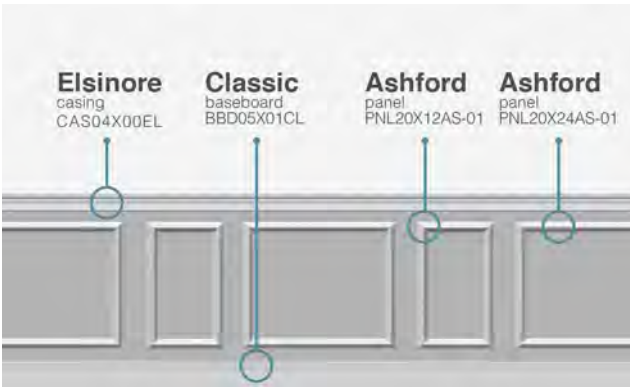

PICTURE FRAME PANEL

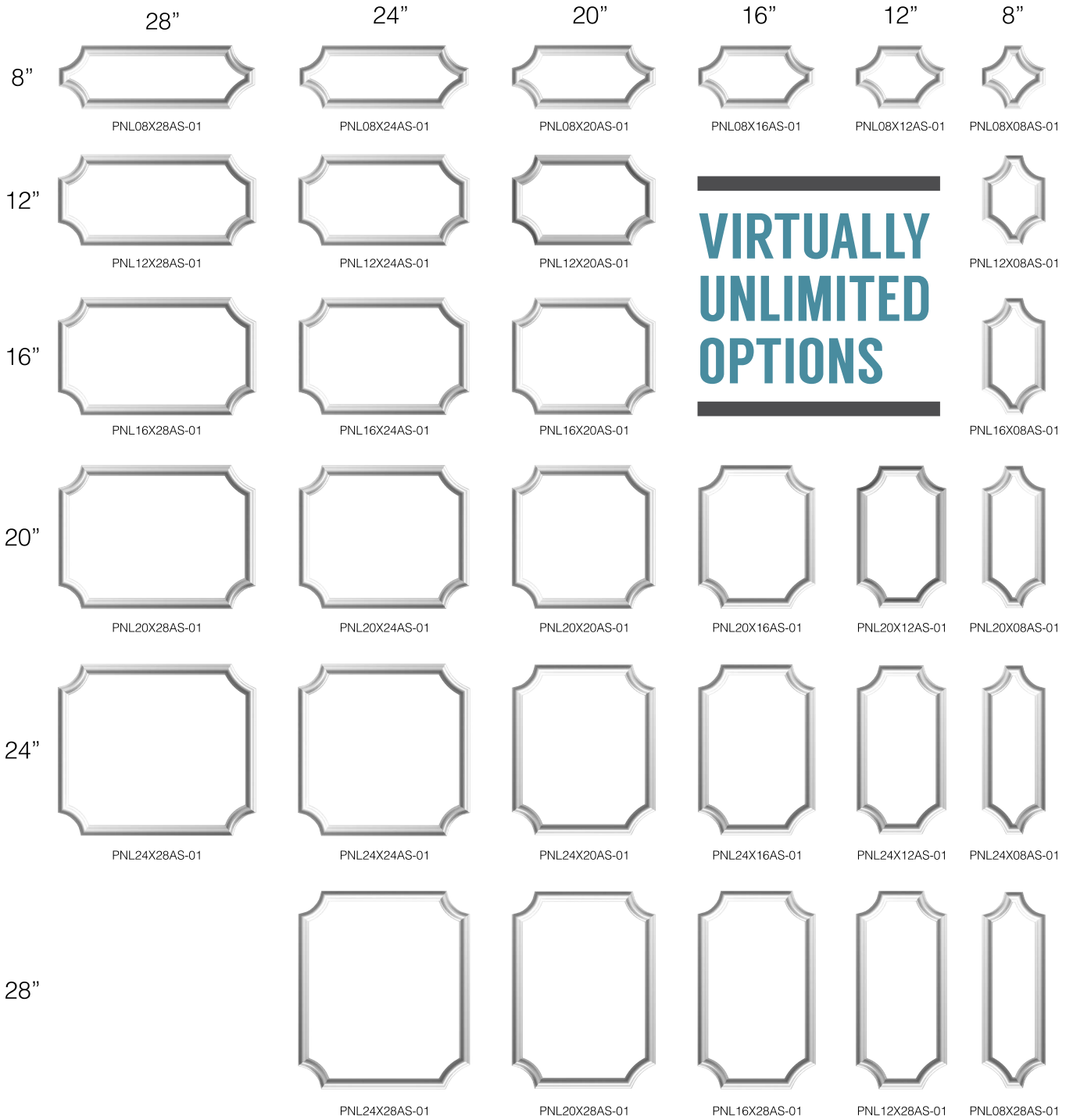

**MATCH PICTURE FRAME
PANELS OR CREATE CUSTOM
SIZES & STYLES WITH THE
ASHFORD PANEL MOULDING.**

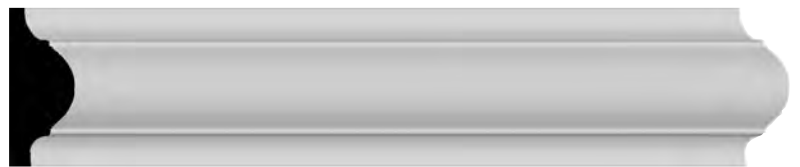

ASHFORD

Product ID

PML01X00AS

H

1 1/2"

P

1/2"

L

96"

PICTURE FRAME PANEL

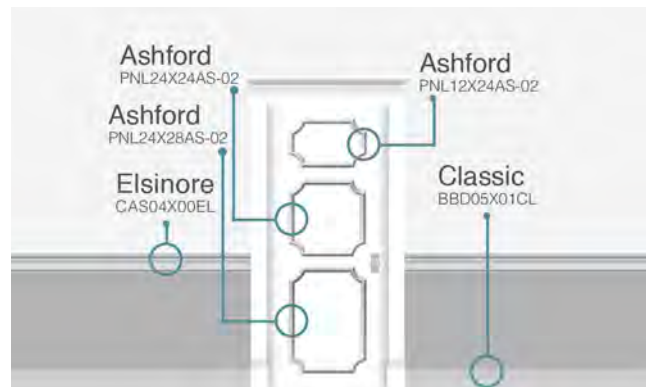
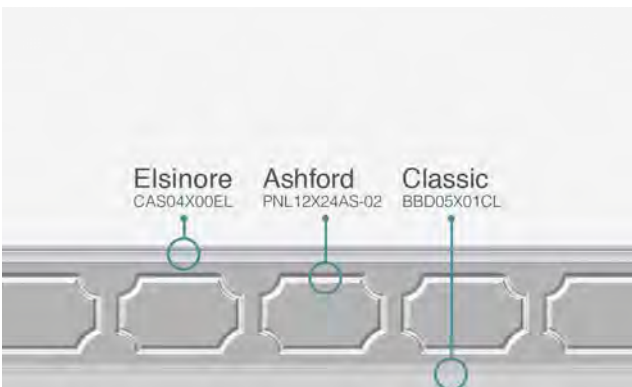
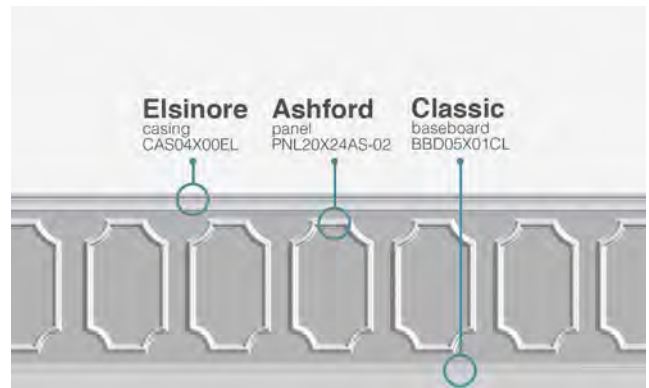
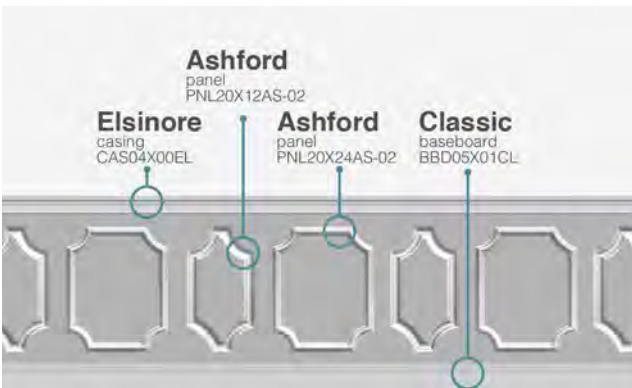

CEILING MEDALLIONS



CEILING MEDALLIONS



ALEXANDRIA

Product ID	OD	ID	P
CM07AL	7 7/8"	0"	3/4"



ODESSA

Product ID	OD	ID	P
CM07OD	7 1/2"	0"	1 1/8"



EMERY

Product ID	OD	ID	P
CM07EM	7 5/8"	0"	1"



EDINBURGH

Product ID	OD	ID	P
CM08ED	7 5/8"	0"	1 1/2"



OLIVIA

Product ID	OD	ID	P
CM07OL	7 7/8"	0"	1 1/8"



MILLIN

Product ID	OD	ID	P
CM08MU	7 7/8"	0"	1/4"



DANIELA

Product ID	OD	ID	P
CM08DN	8"	3 7/8"	1/2"



ANDREA

Product ID	OD	ID	P
CM08AD	8 1/8"	4 1/8"	1/2"

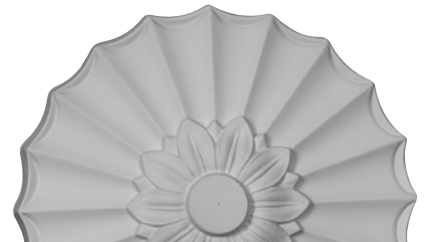

SHAKURAS

Product ID	OD	ID	P
CM09SH	9"	0"	1 3/8"



BENSON

Product ID	OD	ID	P
CM09BN	9"	4 1/8"	5/8"



CEILING MEDALLIONS



CLAREMONT

Product ID	OD	ID	P
CM09CL	9"	4 1/2"	1/2"



MARIA

Product ID	OD	ID	P
CM09MA	9 5/8"	0"	1 1/8"



ANDREA

Product ID	OD	ID	P
CM10AD	10"	6 1/8"	1/2"



DANIELA

Product ID	OD	ID	P
CM10DN	10"	6 1/8"	1/2"



CLAREMONT

Product ID	OD	ID	P
CM10CL	10 5/8"	5 3/4"	1/2"



BENSON

Product ID	OD	ID	P
CM11BN	11 1/8"	6 1/8"	5/8"



LINUS

Product ID	OD	ID	P
CM11LI	11 1/4"	0"	1 1/8"



PALMETTO

Product ID	OD	ID	P
CM11PM	11 3/8"	3 5/8"	7/8"



ACANTHUS

Product ID	OD	ID	P
CM11AC	11 3/8"	0"	2"



LEAF

Product ID	OD	ID	P
CM11LF	11 3/8"	3 5/8"	1 1/8"



PALMETTO

Product ID	OD	ID	P
CM11PA	11 1/2"	0"	1"



WAKEFIELD

Product ID	OD	ID	P
CM11WA	11 3/4"	0"	1-1/4"

CEILING MEDALLIONS



STOCKPORT

Product ID	OD	ID	P
CM12ST	11 3/4"	0"	3/8"



ATTICA

Product ID	OD	ID	P
CM12AT	11 3/4"	4"	1/2"



JEFFERSON

Product ID	OD	ID	P
CM12JE	11 3/4"	0"	3/8"



BLACKTHORN

Product ID	OD	ID	P
CM11BL	11 3/4"	3 5/8"	1"



HELENE

Product ID	OD	ID	P
CM11HE	11 7/8"	3 5/8"	7/8"



ANDREA

Product ID	OD	ID	P
CM12AD	12"	8"	1/2"



DANIELA

Product ID	OD	ID	P
CM12DN	12"	8 1/8"	1/2"



TRADITIONAL

Product ID	OD	ID	P
CM12TR	12"	0"	1"



REECE

Product ID	OD	ID	P
CM12RE	12"	0"	1 3/4"



NADIA

Product ID	OD	ID	P
CM12NA	12 1/8"	3 5/8"	7/8"



PALMETTO

Product ID	OD	ID	P
CM12PM	12 1/8"	3 1/2"	1"



VALERIANO

Product ID	OD	ID	P
CM12VA	12 1/8"	3 5/8"	3/4"

CEILING MEDALLIONS



RIBBON WITH BOW

Product ID	OD	ID	P
CM12RI	12 1/4"	7 1/2"	7/8"



FLOWER

Product ID	OD	ID	P
CM12FL	12 1/4"	0"	2 1/4"



ROPED MEDWAY

Product ID	OD	ID	P
CM12ME	12 1/4"	7 1/2"	7/8"



CEILING MEDALLIONS



JACKSON

Product ID	OD	ID	P
CM12JA	12 1/4"	4"	1 1/8"

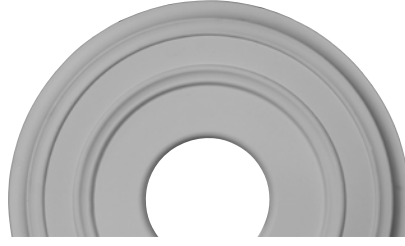

CLASSIC

Product ID	OD	ID	P
CM12CL	12 3/8"	4"	1 1/8"



CARLSBAD

Product ID	OD	ID	P
CM12CA	12 1/2"	0"	1 1/2"



FEDERAL ROPED, SMALL

Product ID	OD	ID	P
CM12FE	12 1/2"	0"	1 1/8"



BRADFORD

Product ID	OD	ID	P
CM12BR	12 1/2"	3 7/8"	3/4"



ACANTHUS

Product ID	OD	ID	P
CM12LE	12 3/4"	0"	7/8"



BENSON

Product ID	OD	ID	P
CM13BN	13 1/8"	8"	5/8"



ORRINGTON

Product ID	OD	ID	P
CM13OR	13 1/4"	6 5/8"	1 1/8"



SALEM

Product ID	OD	ID	P
CM13SA	13 1/4"	7 1/8"	7/8"

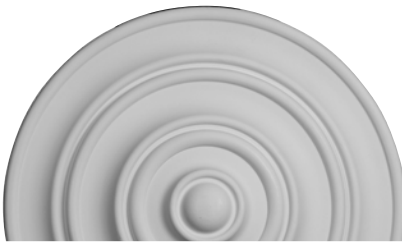

CLASSIC

Product ID	OD	ID	P
CM13CL	13 1/4"	0"	1/2"



BLACKTHORN

Product ID	OD	ID	P
CM13BL	13 3/8"	7 1/2"	3/4"



BRADFORD CLASSIC

Product ID	OD	ID	P
CM13BR	13"	7 1/2"	3/4"

CEILING MEDALLIONS



ASA

Product ID	OD	ID	P
CM13AS	13 3/4"	2 3/4"	3"



MONIQUE

Product ID	OD	ID	P
CM13MO	13 3/4"	0"	1"



TIRANA

Product ID	OD	ID	P
CM13TI	13 7/8"	3 3/4"	1 1/4"



KATHERYN

Product ID	OD	ID	P
CM14KT	14 1/2"	0"	2 3/4"



TRADITIONAL

Product ID	OD	ID	P
CM14TR	14 3/4"	0"	1 3/4"



NEEDHAM

Product ID	OD	ID	P
CM14NE	14 5/8"	0"	2 1/4"



ALEXA

Product ID	OD	ID	P
CM14AX	15"	0"	1 3/4"



BALTIMORE

Product ID	OD	ID	P
CM15BA	15 3/8"	4 1/4"	1 1/2"



FEDERAL

Product ID	OD	ID	P
CM15FE	15 3/8"	3 5/8"	1"



DUBLIN

Product ID	OD	ID	P
CM15DU	15 3/8"	3 5/8"	1"



LISBON

Product ID	OD	ID	P
CM15LI	15 3/8"	7"	1"



COLTON

Product ID	OD	ID	P
CM15CN	15 3/4"	0"	1 1/2"

CEILING MEDALLIONS



DEVON

Product ID	OD	ID	P
CM15DE	15 3/4"	0"	1 1/2"



BERKSHIRE

Product ID	OD	ID	P
CM15BE	15 3/4"	3 7/8"	3/4"



CHESTER

Product ID	OD	ID	P
CM15CH	15 3/4"	0"	1 7/8"



ARTIS

Product ID	OD	ID	P
CM15AR	15 3/4"	0"	1 3/8"



FOSTER

Product ID	OD	ID	P
CM15FO	15 3/4"	0"	2"



AMELIA

Product ID	OD	ID	P
CM16AM	15 3/4"	0"	5/8"



GRANADA

Product ID	OD	ID	P
CM16GA	15 3/4"	0"	5/8"



KIRKE

Product ID	OD	ID	P
CM16KI	15 3/4"	0"	5/8"



LUTON

Product ID	OD	ID	P
CM16LU	15 3/4"	0"	5/8"



GALWAY

Product ID	OD	ID	P
CM15GA	15 3/4"	4 1/8"	1"

**DON'T SEE WHAT YOU'RE LOOKING FOR?
CALL US!**

CEILING MEDALLIONS



MELONIE

Product ID	OD	ID	P
CM16ML	16"	3 5/8"	3/4"



GENEVIEVE

Product ID	OD	ID	P
CM16GN	16 1/8"	3 1/2"	7/8"

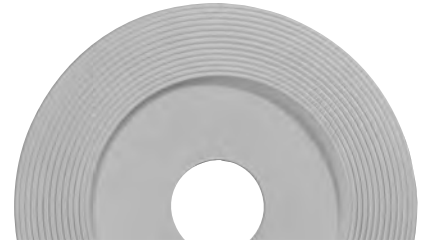

ADONIS

Product ID	OD	ID	P
CM16AD	16 1/8"	3 5/8"	1"



CEILING MEDALLIONS



WIGAN

Product ID	OD	ID	P
CM16WG	16"	0"	2 1/4"



TYRONE

Product ID	OD	ID	P
CM16TY	16 1/8"	0"	3/4"



MARSEILLE

Product ID	OD	ID	P
CM16MA	16 1/8"	0"	5/8"



WREATH

Product ID	OD	ID	P
CM16WR	16 1/4"	3 5/8"	1"



SOUTHAMPTON

Product ID	OD	ID	P
CM17SO	16 3/8"	0"	1 3/4"



MEDEA

Product ID	OD	ID	P
CM16ME	16 1/2"	3 7/8"	1 1/2"



SOUTHAMPTON

Product ID	OD	ID	P
CM16SO	16 1/2"	0"	2 3/8"



MEDEA

Product ID	OD	ID	P
CM16MD	16 1/2"	0"	1 1/2"



APOLLO

Product ID	OD	ID	P
CM16AP	16 1/2"	3 5/8"	1 1/8"

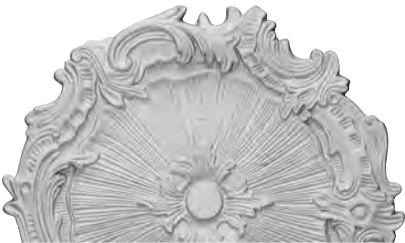

PLYMOUTH

Product ID	OD	ID	P
CM16PL	16 3/4"	0"	1 3/8"

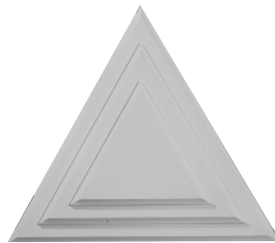

TRIANGLE

Product ID	H	W	P
CM19TG	19 1/4"	19 1/4"	1 1/8"

over
300
medallions

CEILING MEDALLIONS



EMERY

Product ID	OD	ID	P
CM16ER	16 7/8"	0"	5/8"



SWINDON

Product ID	OD	ID	P
CM16SW	16 7/8"	0"	1 1/2"



OXFORD

Product ID	W	H	P
CM16OX	16 7/8"	0"	1 1/2"



VIENNA

Product ID	OD	ID	P
CM17VI	16 7/8"	0"	5/8"



WASHINGTON

Product ID	OD	ID	P
CM17WA	17 1/8"	0"	1 1/2"



FEDERAL ROPED, LARGE

Product ID	OD	ID	P
CM17FE	17 3/8"	0"	1 1/8"



HAMILTON

Product ID	OD	ID	P
CM17HA	17 3/8"	0"	1 3/4"



MUNICH

Product ID	OD	ID	P
CM17MU	17 1/2"	3 5/8"	1"



PRESTON

Product ID	OD	ID	P
CM17PR	17 1/2"	4"	1"



CAMBRIDGE

Product ID	OD	ID	P
CM17CA	17 5/8"	0"	1 1/8"



ORLEANS

Product ID	OD	ID	P
CM17OL	17 5/8"	3 5/8"	1 7/8"



RAYMOND TWO PIECE

Product ID	OD	ID	P
CM17RA2	17 5/8"	3 5/8"	7/8"

CEILING MEDALLIONS



PERALTA

Product ID	OD	ID	P
CM17PE	17 3/4"	3 1/8"	1"



EXETER

Product ID	OD	ID	P
CM17EX	17 3/4"	0"	1 1/8"



TELFORD

Product ID	OD	ID	P
CM17TE	17 3/4"	0"	1 1/2"



DUBLIN

Product ID	OD	ID	P
CM17DU	17 7/8"	3 5/8"	1 1/4"



LEGACY

Product ID	OD	ID	P
CM17LE	17 7/8"	0"	1 1/8"



TERRONES

Product ID	OD	ID	P
CM17TS	17 7/8"	3 7/8"	1"



ROTHERHAM

Product ID	OD	ID	P
CM17RO	18"	3 1/2"	1 1/2"



CRAWLEY

Product ID	OD	ID	P
CM18CR	18"	3 1/4"	1 1/2"



EDINBURGH

Product ID	OD	ID	P
CM18ED	18"	0"	1 3/4"



ERIS

Product ID	W	H	P
CM18ER	18"	18"	1 1/8"

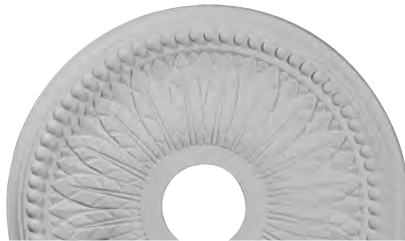

BAILEY

Product ID	OD	ID	P
CM18BI	18"	3 3/4"	1 1/2"



KENT

Product ID	OD	ID	P
CM18KE	18"	3 1/2"	1 1/4"

CEILING MEDALLIONS



OLDHAM

Product ID	OD	ID	P
CM18OL1	18"	3 3/8"	7/8"



NIOBE

Product ID	OD	ID	P
CM18NI	18"	0"	1 1/2"



NORWICH

Product ID	OD	ID	P
CM18NO	18"	3 1/2"	1 3/8"



NOTTINGHAM

Product ID	OD	ID	P
CM18NT	18"	3 1/2"	1 1/2"



OLDHAM

Product ID	OD	ID	P
CM18OL	18"	0"	1 1/4"



DIANE

Product ID	OD	ID	P
CM18DI	18"	3 5/8"	1 1/8"



RAYMOND

Product ID	OD	ID	P
CM18RA2	18"	0"	1 1/4"



ATTICA

Product ID	OD	ID	P
CM18AT	18"	4"	5/8"



RICHMOND

Product ID	OD	ID	P
CM18RI	18"	0"	1 3/8"



WARSAW

Product ID	OD	ID	P
CM18WA	18"	3 1/2"	1 3/8"



RILEY

Product ID	OD	ID	P
CM18RL	18"	3 1/2"	1 1/2"



ANTIOCH

Product ID	OD	ID	P
CM18SE	18"	3 1/2"	1 3/8"

CEILING MEDALLIONS



ROSE

Product ID	OD	ID	P
CM18RO	18"	3 1/2"	1 1/2"



VALLETTA

Product ID	OD	ID	P
CM18VL	18"	3 1/2"	1"



RAYMOND

Product ID	OD	ID	P
CM18RA	18 1/8"	3 5/8"	1 1/8"



KATHERYN

Product ID	OD	ID	P
CM18KA	18 1/8"	0"	1 1/4"



BRADFORD

Product ID	OD	ID	P
CM18BR	18 1/8"	3 3/4"	1 1/8"



EDINBURGH

Product ID	OD	ID	P
CM18ED1	18 1/8"	3 1/2"	2 3/4"



BAILEY

Product ID	OD	ID	P
CM19BI	18 1/8"	0"	3/4"

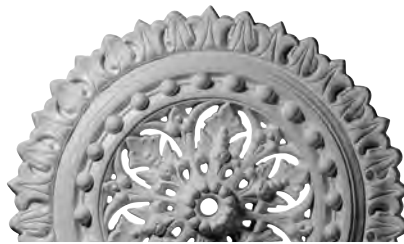

SELLEK

Product ID	OD	ID	P
CM18SK	18 1/2"	1 1/8"	1 1/2"



KENDALL

Product ID	OD	ID	P
CM18KD	18 1/2"	3 7/8"	1"

**NEED A HOLE
DRILLED IN THE CENTER?
WE CAN DO IT!**

CEILING MEDALLIONS

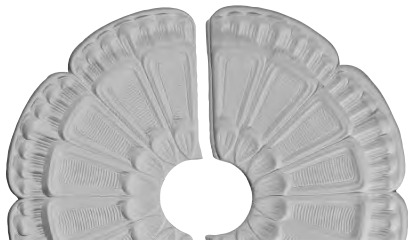

FLOWER

Product ID	OD	ID	P
CM18FW2	18 1/2"	3 5/8"	7/8"



SAVERNE

Product ID	W	H	P
CM18SA	18 1/2"	13 1/2"	1 7/8"



CLASSIC

Product ID	OD	ID	P
CM19CL	18 5/8"	4"	1 1/8"



POMPEII

Product ID	OD	ID	P
CM18PO	18 7/8"	0"	1 1/2"



GRANADA

Product ID	OD	ID	P
CM19GA	19"	0"	1 1/2"



FOSTER

Product ID	OD	ID	P
CM19FO	19 1/8"	0"	1"



GRANADA

Product ID	OD	ID	P
CM18GA	19 1/8"	3 3/4"	2 1/2"

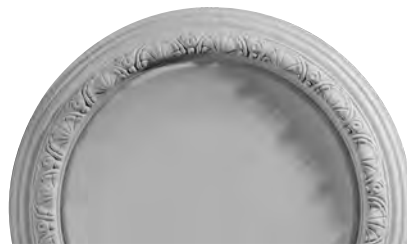

CARLSBAD

Product ID	OD	ID	P
CM19CA	19 1/2"	0"	1 3/4"



ALEXANDRIA

Product ID	OD	ID	P
CM18AL	19 5/8"	0"	1 1/2"



AMELIA

Product ID	OD	ID	P
CM20AM	19 5/8"	0"	3/4"



ORRINGTON

Product ID	OD	ID	P
CM19OR	19 5/8"	4 3/4"	1 3/8"

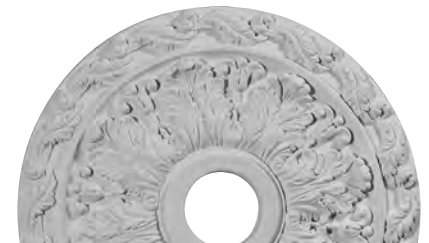

SPRING LEAF

Product ID	OD	ID	P
CM19SP	19 7/8"	3 5/8"	1 1/4"

CEILING MEDALLIONS



LEANDROS

Product ID	OD	ID	P
CM22LN	19 7/8"	0"	1 1/5"



VIENNA

Product ID	OD	ID	P
CM20VI	20"	3 1/2"	1 1/2"



JACKSON

Product ID	OD	ID	P
CM20JA	20"	3 5/8"	1"



DAMON

Product ID	OD	ID	P
CM20DA	20"	0"	1 1/2"



RANEE

Product ID	OD	ID	P
CM20HA	20"	0"	1 3/8"



BAILE

Product ID	OD	ID	P
CM20BL	20"	0"	1 5/8"



BONETTI

Product ID	OD	ID	P
CM20BO	20"	0"	1 3/4"



BERKSHIRE

Product ID	OD	ID	P
CM20BE1	20 1/8"	3 7/8"	1 7/8"



LUNEL

Product ID	OD	ID	P
CM20LU	20 1/4"	0"	1 1/2"



DERIA

Product ID	OD	ID	P
CM20DR	20 1/4"	0"	1 1/2"



ALEXA

Product ID	OD	ID	P
CM20AL	20 1/2"	0"	1 7/8"



FOSTER ACANTHUS LEAF

Product ID	OD	ID	P
CM20FO	20 1/2"	0"	1 1/2"

CEILING MEDALLIONS



RAYNOR

Product ID	OD	ID	P
CM20BE	20 5/8"	0"	1 3/8"

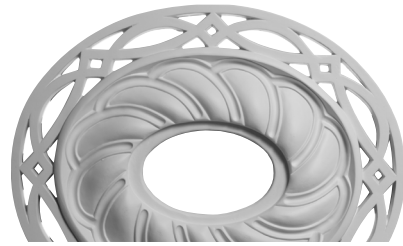

LOERA

Product ID	W	H	P
CM20X17LO	20 5/8"	17 1/2"	1 1/8"



LAUREN

Product ID	OD	ID	P
CM20LN	20 5/8"	6 1/4"	1 3/8"

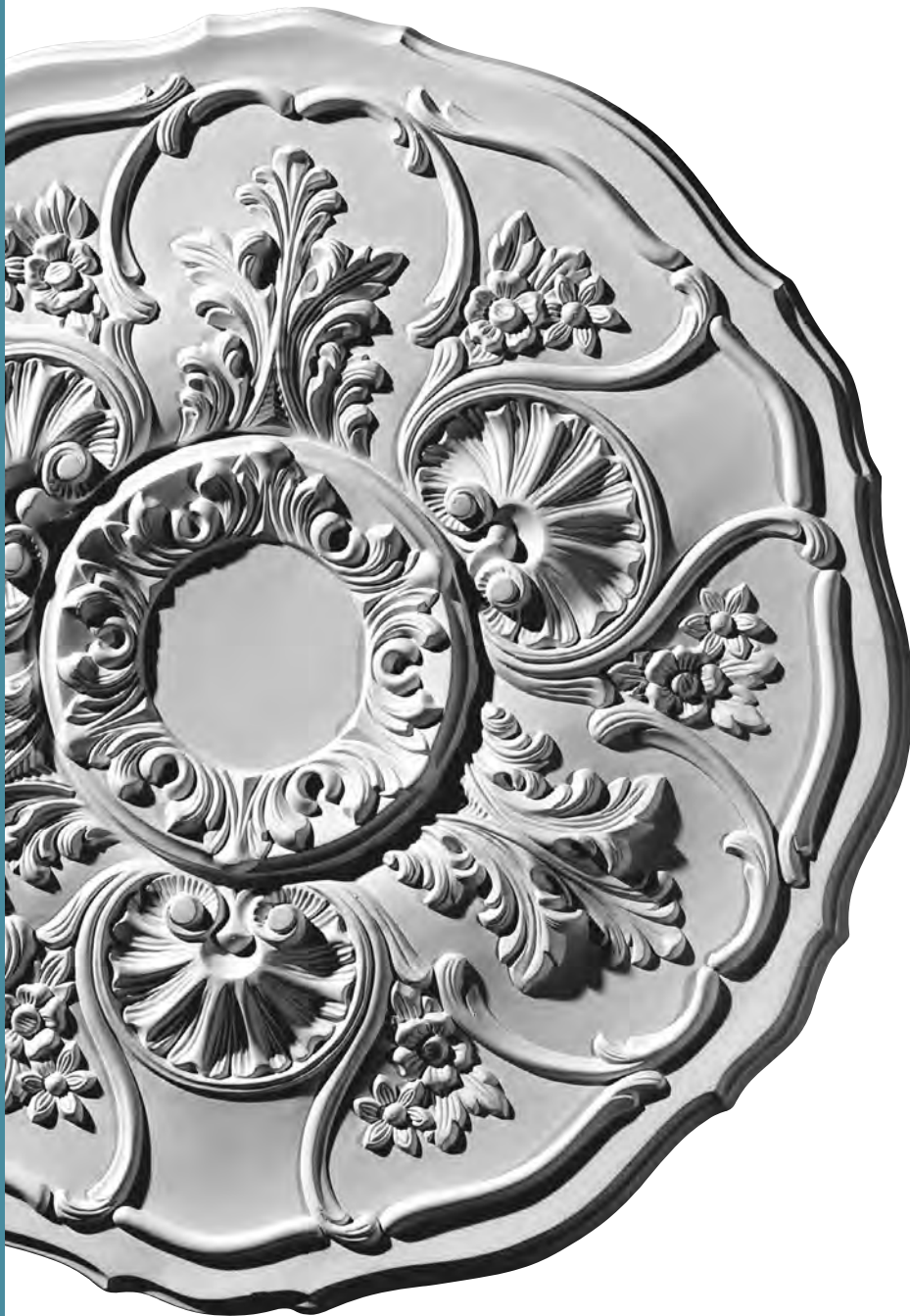

ANGEL

Product ID	OD	ID	P
CM20AN	20 7/8"	3 5/8"	1"



HOLMDEL

Product ID	OD	ID	P
CM20HO	20 7/8"	12 7/8"	1"



PALMETTO

Product ID	OD	ID	P
CM20PM	20 7/8"	3 5/8"	1 5/8"

CEILING MEDALLIONS



BIDDIX

Product ID	OD	ID	P
CM20BX	20 7/8"	0"	1 1/4"



LUTON

Product ID	OD	ID	P
CM21LU	21"	0"	2"



MARSEILLE

Product ID	OD	ID	P
CM21MA	21"	0"	2"



REECE

Product ID	OD	ID	P
CM21RE	21"	0"	1 1/4"



WREATH

Product ID	OD	ID	P
CM21WR	21 1/8"	3 5/8"	7/8"



WALTZ

Product ID	W	H	P
CM21WA	21 1/4"	17 3/8"	1"



YORK

Product ID	OD	ID	P
CM21YO	21 5/8"	0"	2 1/2"



ROBIN

Product ID	OD	ID	P
CM22RB	22 1/4"	4 3/4"	1 1/5"



ORRINGTON

Product ID	OD	ID	P
CM22OR	22"	6 1/4"	1 3/4"



TRINITY

Product ID	OD	ID	P
CM22TN	22"	0"	1 3/4"



ANTHONY HARVEST

Product ID	OD	ID	P
CM22AT	22 1/2"	0"	1 1/5"



CORNELIA

Product ID	OD	ID	P
CM22CN	22 1/2"	0"	1 1/2"

CEILING MEDALLIONS

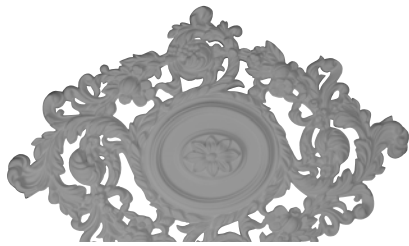

KATHERYN

Product ID	W	H	P
CM30KT	22 1/2"	30 3/8"	1 1/2"



BORDEAUX

Product ID	OD	ID	P
CM22BO	22 5/8"	0"	1 3/4"



GRAPE

Product ID	OD	ID	P
CM22GR	22 5/8"	3 5/8"	5/8"

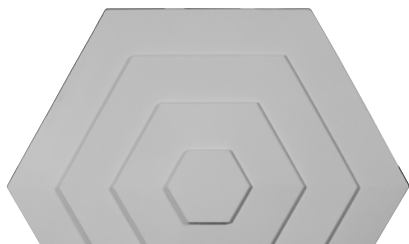

WOODRUFF

Product ID	OD	ID	P
CM23WF	23 1/4"	0"	7/8"



GRANADA

Product ID	OD	ID	P
CM23GA	23 3/8"	3 5/8"	2 1/4"



LYON

Product ID	OD	ID	P
CM23LY	23 1/2"	0"	3 1/4"



QUENTIN

Product ID	W	H	P
CM23RO1	23 1/2"	12 1/4"	1 1/2"



VADUZ

Product ID	OD	ID	P
CM23VA	23 1/2"	3 1/2"	2 1/8"



MODENA

Product ID	OD	ID	P
CM23MO	23 1/2"	0"	3 1/2"



GRANADA

Product ID	OD	ID	P
CM24GA	23 1/2"	0"	2 3/4"



FLORAL

Product ID	OD	ID	P
CM23FL	23 1/2"	0"	2 3/4"



BRISTOL

Product ID	OD	ID	P
CM23BI	23 1/2"	3 7/8"	1"

CEILING MEDALLIONS



ACANTHUS TWIST

Product ID	OD	ID	P
CM23AC	23 5/8"	4 5/8"	1 7/8"



BORDEAUX DELUXE

Product ID	OD	ID	P
CM23BO	23 5/8"	3"	2"



BELLONA

Product ID	OD	ID	P
CM23BE	23 5/8"	3 5/8"	1 1/8"



ROSE & RIBBON

Product ID	OD	ID	P
CM23RO	23 5/8"	4"	1 1/2"



PALMETTO

Product ID	OD	ID	P
CM23PM	23 5/8"	3 5/8"	1 5/8"



KAYA

Product ID	OD	ID	P
CM23KA	23 5/8"	0"	1 1/2"



JAMIE

Product ID	OD	ID	P
CM23JA	23 5/8"	3 7/8"	2 1/8"



LUTON

Product ID	OD	ID	P
CM23LU	23 3/4"	3 5/8"	1 7/8"



ASHLEY

Product ID	OD	ID	P
CM23AS	23 7/8"	4 7/8"	2 1/8"



SWINDON

Product ID	OD	ID	P
CM24SW	24"	4 1/4"	1 1/2"



DIANE

Product ID	OD	ID	P
CM24DI	24"	3 5/8"	1 1/4"



LOGAN

Product ID	OD	ID	P
CM24LO	24"	0"	1 3/4"

CEILING MEDALLIONS



WALTZ

Product ID	W	H	P
CM24WA	24"	0"	1 1/8"



THEIA

Product ID	OD	ID	P
CM24TH	24"	3 3/4"	1 3/4"

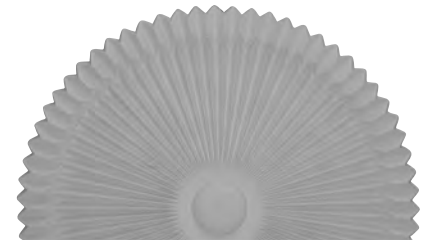

SHAKURAS

Product ID	OD	ID	P
CM24SH	24"	0"	3"



TEMPLE

Product ID	OD	ID	P
CM24TE	24"	0"	1 5/8"



NEUVEAU

Product ID	OD	ID	P
CM24NA	24 1/4"	0"	2"



LOGAN

Product ID	OD	ID	P
CM24LO1	24 1/4"	3 7/8"	2"



CAPUTO

Product ID	OD	ID	P
CM24CA	24 1/4"	0"	1 1/2"

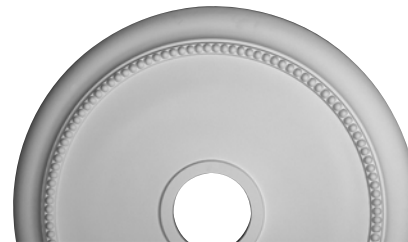

CRENDON

Product ID	OD	ID	P
CM24CR	24 1/8"	3 5/8"	2 1/4"



TRADITIONAL

Product ID	OD	ID	P
CM24TR	24 3/8"	0"	1 1/2"



REECE

Product ID	OD	ID	P
CM24RE	24 3/8"	0"	1 1/8"



VICTORIAN

Product ID	OD	ID	P
CM24VI	24 3/8"	0"	1"

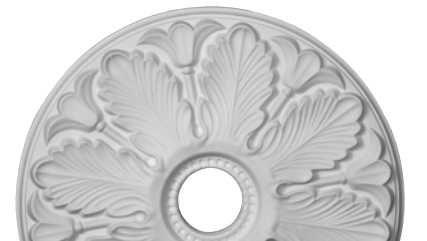

MILAN

Product ID	OD	ID	P
CM24MI	24 1/2"	1"	3 1/2"

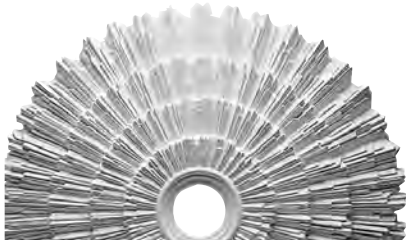

ERYN

Product ID

OD

ID

P

CM24EN

24 3/4"

3 1/4"

1 7/8"

CHECK OUT PAGE 288 FOR OUR
NUMEROUS **COLOR** OPTIONS AS
WELL AS FINISHES THAT SIMULATE
WOOD & SPECIALTY METAL.



CEILING MEDALLIONS



LARIAH

Product ID	OD	ID	P
CM24LA	24 3/4"	1 3/8"	3 1/4"



MADRID

Product ID	W	H	P
CM24X12MA	24 3/4"	12 1/2"	1 3/4"



FELIX

Product ID	W	H	P
CM25FE	25 1/4"	17 1/4"	1 3/4"



SPIRAL

Product ID	OD	ID	P
CM25SP	25 1/4"	4"	2"

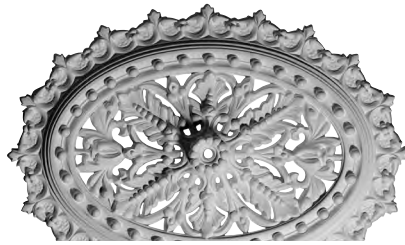

SELLEK

Product ID	W	H	P
CM25X18SK	25 1/4"	18 7/8"	3 1/5"



COLE

Product ID	OD	ID	P
CM25CO	25 3/8"	3 3/8"	1 3/8"



BRONTES

Product ID	OD	ID	P
CM25BR	25 1/2"	0"	5 1/2"



SHELL

Product ID	OD	ID	P
CM25SH	25 5/8"	0"	1"



NESTOR

Product ID	OD	ID	P
CM25NE	25 7/8"	0"	2 1/4"



TRISTAN

Product ID	OD	ID	P
CM26TN	26"	0"	3"



VINCENT

Product ID	OD	ID	P
CM26VI	26"	0"	3"

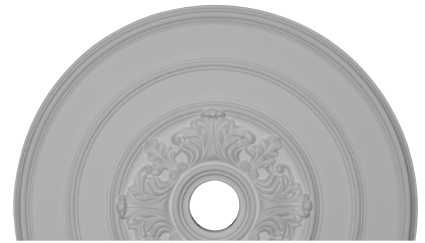

TRADITIONAL with ACANTHUS LEAVES

Product ID	OD	ID	P
CM26TA	26"	3 1/8"	1 1/2"

CEILING MEDALLIONS



ATTICA WITH ROSE

Product ID	OD	ID	P
CM26AT	26"	3 3/4"	1 1/2"



HURLEY

Product ID	OD	ID	P
CM26HU	26 1/8"	7 1/4"	1 3/4"



ATHENS

Product ID	OD	ID	P
CM27AT	26 1/4"	0"	3 1/4"



PEARL

Product ID	OD	ID	P
CM26PE	26 1/4"	0"	1 1/2"



MARCELLA

Product ID	W	H	P
CM26MR	26 3/8"	17 1/4"	1 3/4"



JEFFERSON

Product ID	OD	ID	P
CM26JE	26 1/2"	3 5/8"	1 1/2"



ELSINORE

Product ID	OD	ID	P
CM26EL	26 3/4"	3 5/8"	1 3/8"



LEAF

Product ID	OD	ID	P
CM26LF	26 3/4"	3 5/8"	1 1/8"



CHRISTOPHER

Product ID	OD	ID	P
CM26CS	26 5/8"	0"	2 1/4"

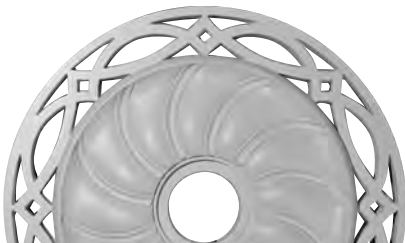

LOERA

Product ID	OD	ID	P
CM26LO	26 5/8"	4 1/2"	1 3/8"



BRUNSWICK

Product ID	OD	ID	P
CM27BR	27"	0"	2 1/2"



FLOWER

Product ID	OD	ID	P
CM27FL	27"	0"	1 1/8"

CEILING MEDALLIONS



ARTIS

Product ID	OD	ID	P
CM27AR	27 1/8"	0"	2 5/8"

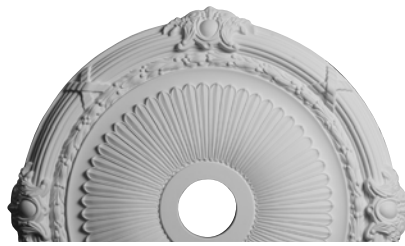

HEATON

Product ID	OD	ID	P
CM27HE	27 1/2"	3 7/8"	2 1/4"



WINSOR

Product ID	OD	ID	P
CM27WI	27 1/2"	4"	1 1/2"



SYDNEY

Product ID	OD	ID	P
CM27SY	27 3/4"	0"	2"



TOMANGO EGG & DART

Product ID	OD	ID	P
CM27TO	27 7/8"	3 7/8"	2 1/2"



ASHFORD

Product ID	W	H	P
CT28X28AS	28 3/4"	28 3/4"	1 1/8"



STOCKPORT

Product ID	OD	ID	P
CM28ST	28"	0"	2 3/4"



OSLO

Product ID	OD	ID	P
CM28OS	28 1/8"	0"	1 3/4"

CEILING MEDALLIONS



BENSON CLASSIC

Product ID	OD	ID	P
CM28BE	28 3/8"	4 1/2"	1 5/8"



NICOLE

Product ID	OD	ID	P
CM28NI	28 3/4"	7/8"	1 7/8"



FLOWER

Product ID	OD	ID	P
CM29FW	29"	3 5/8"	1 3/8"



CARTON

Product ID	OD	ID	P
CM29CA	29 1/8"	0"	1 1/2"

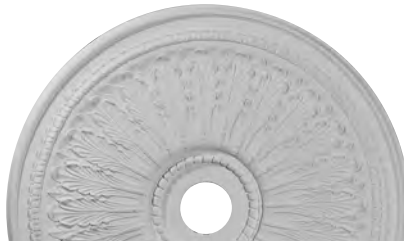

OAKLEAF

Product ID	OD	ID	P
CM29OA	29 1/8"	3 5/8"	1"



SPRING OCTAGONAL

Product ID	OD	ID	P
CM30SP	29 1/8"	2 1/4"	1 1/8"



HAYLYNN

Product ID	OD	ID	P
CM29HY	29 1/8"	1 1/4"	4"



CATHEDRAL

Product ID	W	H	P
CM29X38CA	38 1/8"	29 1/8"	1 3/4"



DARNAY

Product ID	OD	ID	P
CM29DA	29 1/4"	0"	2"



SPRINGTIME

Product ID	OD	ID	P
CM29SP	29 3/8"	0"	2 7/8"



ANTHONY

Product ID	OD	ID	P
CM29AT	29 3/8"	11 5/8"	1 1/8"



SUNFLOWER

Product ID	OD	ID	P
CM29SF	29 1/2"	3 5/8"	1 5/8"

CEILING MEDALLIONS



WIGAN

Product ID	OD	ID	P
CM29WG	29 3/4"	0"	1 1/2"



FAIRFAX

Product ID	OD	ID	P
CM29FA	29 7/8"	0"	1 3/8"



ALEXA

Product ID	W	H	P
CM21X30AL	30 3/4"	21 1/4"	1 5/8"



NEXUS

Product ID	OD	ID	P
CM30NE	30"	0"	1 1/4"



DYLAR

Product ID	OD	ID	P
CM30DY	30"	0"	2 1/4"



ATTICA

Product ID	OD	ID	P
CM30AT	30 1/8"	0"	1 1/2"



FLAGSTONE

Product ID	OD	ID	P
CM30FL	30"	3 7/8"	3 1/4"



STRASBOURG

Product ID	W	H	P
CM30SG	30 1/2"	20"	1 1/2"



KINSLEY

Product ID	W	H	P
CM30KI	30 3/8"	20 3/4"	1"



ROSE

Product ID	OD	ID	P
CM30RO	30 7/8"	3 5/8"	1 3/8"



TELLSON

Product ID	OD	ID	P
CM30TE	30 5/8"	0"	2 1/2"



DURHAM

Product ID	OD	ID	P
CM31DU	31"	0"	1 1/2"

CEILING MEDALLIONS



CARLSBAD

Product ID	OD	ID	P
CM31CA	31 1/8"	0"	1 1/2"



BAILE

Product ID	OD	ID	P
CM31BA	31 1/4"	0"	2 1/4"



PALMETTO

Product ID	OD	ID	P
CM31PM	31 1/2"	3 5/8"	1 3/4"



TRADITIONAL

Product ID	OD	ID	P
CM31TR	31 1/2"	0"	2 1/2"



KIRKE

Product ID	OD	ID	P
CM31KI	31 1/2"	3 5/8"	1 1/2"

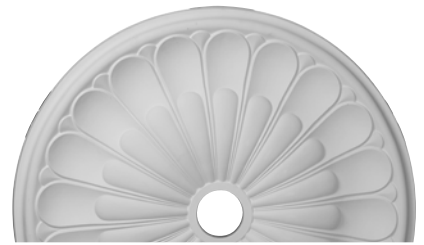

GORLEEN

Product ID	OD	ID	P
CM31GO	31 5/8"	3 5/8"	1 7/8"



ANGEL

Product ID	OD	ID	P
CM32AN	32 1/4"	3 5/8"	1 1/8"



DEFARGE

Product ID	OD	ID	P
CM32DE	32 1/4"	0"	3 3/4"



TRISTAN

Product ID	OD	ID	P
CM32TN	32 3/8"	0"	3 1/2"



GIANA

Product ID	OD	ID	P
CM32GI	32 5/8"	0"	1 1/2"



BRADFORD

Product ID	OD	ID	P
CM32BR	32 5/8"	0"	2"



JACKSON

Product ID	OD	ID	P
CM32JA	32 3/4"	0"	2 1/2"

CEILING MEDALLIONS



VERSAILLES

Product ID	OD	ID	P
CM33VE	33"	0"	1 3/4"

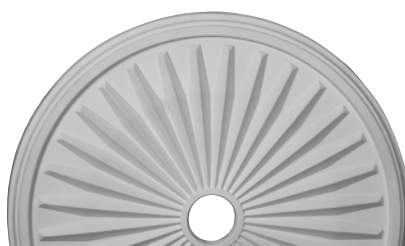

LEANDROS

Product ID	OD	ID	P
CM33LE	33 1/8"	3 1/2"	1 3/8"



SCROLL

Product ID	OD	ID	P
CM33SC	33 1/4"	3 5/8"	1"



DAUPHINE

Product ID	OD	ID	P
CM33DA	33 7/8"	0"	1 3/8"



ROSE

Product ID	OD	ID	P
CM33RO	33 7/8"	0"	2 3/8"



VICEROY

Product ID	OD	ID	P
CM35VI	35 1/8"	3 7/8"	2 1/2"



BONETTI

Product ID	OD	ID	P
CM34BO	35 3/8"	0"	1 1/4"



ANTONIO

Product ID	W	H	P
CM35X22AN	35 7/8"	22 1/2"	4 3/8"



JUNIPER

Product ID	OD	ID	P
CM36JU	36"	0"	1 1/2"



MELONIE

Product ID	OD	ID	P
CM36ME	36 1/4"	0"	1 7/8"



GALVESTON

Product ID	OD	ID	P
CM36GL	36 5/8"	3 5/8"	2 3/8"



NAPLE

Product ID	OD	ID	P
CM37NA	37 1/2"	0"	3 3/8"

CEILING MEDALLIONS



ANTILLES

Product ID	OD	ID	P
CM38AN	38 1/4"	0"	1 1/2"



ORLEANS

Product ID	OD	ID	P
CM38OL	38 3/8"	6 1/4"	2 7/8"



OSLO

Product ID	OD	ID	P
CM38OS	38 3/8"	0"	2 7/8"



CEILING MEDALLIONS



ATTICA

Product ID	OD	ID	P
CM39AT	39 1/2"	0"	2 1/2"



DELFINA

Product ID	OD	ID	P
CM40DL	40"	0"	1 7/8"



CLASSIC

Product ID	OD	ID	P
CM40CL	40 1/4"	0"	3 1/8"



MILTON

Product ID	OD	ID	P
CM40MI	40 5/8"	0"	1 3/4"

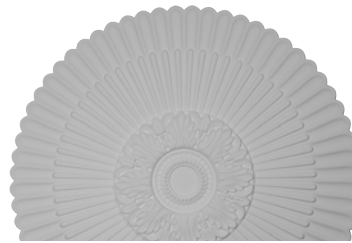

NEXUS

Product ID	OD	ID	P
CM41NE	41"	0"	1 5/8"



CAPUTO

Product ID	OD	ID	P
CM41CA	41"	4"	2 3/8"



LARGE FLORAL

Product ID	OD	ID	P
CM41FL	41 1/8"	0"	2 1/2"



CLASSIC

Product ID	OD	ID	P
CM41CL	41 1/8"	4"	2 1/8"



SPRINGTIME

Product ID	OD	ID	P
CM42SP	42 1/2"	0"	4 5/8"



SELLEK

Product ID	OD	ID	P
CM42SK	42 1/8"	0"	1 7/8"



ASHFORD

Product ID	W	H	P
CM42X28AS	42 3/4"	28 7/8"	3/4"



CLASSIC

Product ID	OD	ID	P
CM44CL	44 1/2"	4"	4"

CEILING MEDALLIONS



MILAN

Product ID	OD	ID	P
CM47MI	47 5/8"	0"	2 3/4"



LORRY

Product ID	OD	ID	P
CM50LO	50 1/8"	3 5/8"	1 3/4"



GALVESTON

Product ID	OD	ID	P
CM51GL	51"	3 5/8"	3 3/8"

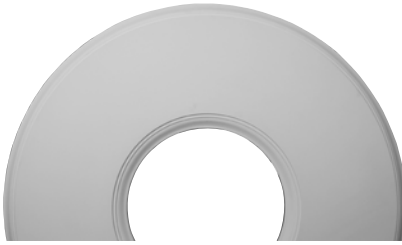

DECO

Product ID	OD	ID	P
CM51DC	51 1/8"	20 1/8"	2"



NEVIO

Product ID	OD	ID	P
CM51NE	51 1/8"	3 5/8"	1 1/2"



ATTICA

Product ID	OD	ID	P
CM53AT	53 1/2"	0"	3 1/2"



CLASSIC

Product ID	OD	ID	P
CM54TCL	54"	0"	4 7/8"



MILTON

Product ID	OD	ID	P
CM54MI	54 1/4"	0"	2 7/8"



PIEDMONT

Product ID	W	H	P
CM67PE	67 1/8"	48 5/8"	1 7/8"



MELCHOR

Product ID	W	H	P
CM70X43ML	70 7/8"	43 3/4"	2"



partnering with contractors, installers, designers, & architects

MEDALLION FINISHES

FLAT PAINT AND CUSTOM FINISHES

We individually hand finish each of our millwork products and therefore can offer a complete line of custom finishes. If you have a design style or finish in mind, please contact your Ekena Millwork dealer for pricing and availability. Since each medallion is made especially for you, they are non-refundable.



ATHENIAN GREEN



BLACK



BRUSHED MAHOGANY



CLEAR YELLOW



CLOUD BURST



FROST



GOBI DESERT



MIDNIGHT DREAM



MISSISSIPPI MUD

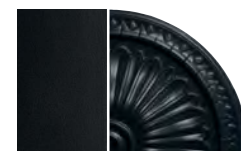

NIGHT SHADE



POT OF CREAM



SMOKEY TOPAZ

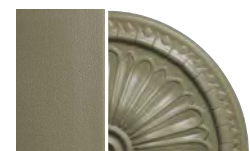

SPARTAN STONE

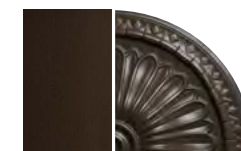

STONE HEARTH



ULTRA PURE WHITE



AMERICANA



FIREBRICK



PAINTED TURTLE

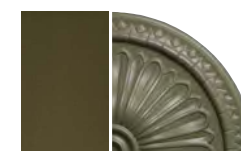

WITCH HAZEL

SPECIALTY CRACKLE FINISHES

Our specialty crackle finishes bring a unique and elegant twist to the traditionally painted ceiling medallion. Each crackle finish is hand painted by one of our experts to ensure an even crackle and quality finished product.



ROOT BEER
CRACKLE



SMOKEY TOPAZ
CRACKLE



ULTRA PURE
WHITE CRACKLE

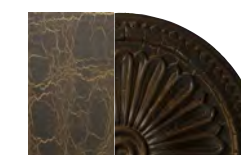

STONE HEARTH
CRACKLE



POT OF CREAM
CRACKLE



GOBI DESERT
CRACKLE



MISSISSIPPI MUD
CRACKLE



BURNISHED MAHOGANY
CRACKLE



WITCH HAZEL
CRACKLE



AMERICANA
CRACKLE



ATHENIAN GREEN
CRACKLE



PAINTED TURTLE
CRACKLE



CLOUD BURST
CRACKLE

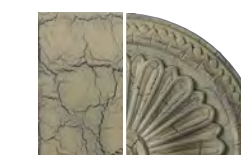

CASTLE STONE
CRACKLE

MEDALLION FINISHES

SPECIALTY METAL AND WOOD FINISHES

Our specialty finishes are hand painted, creating high quality, one of a kind medallions. They come in metal and wood finishes, including our most popular finish, rust. Once painted, they are sealed for lasting protection. If you are looking for high end, high quality finishes you're looking in the right place.



BLACK PEARL



BRASS



BRONZE BLUE
PATINA



BRONZE

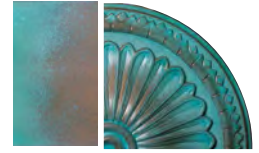

COPPER GREEN
PATINA



FLASH GOLD



COPPER PENNY



FLASH BLUE



GREEN GOLD



IRIDESCENT GOLD



PEARL WHITE



PEWTER



PHARAOH'S GOLD



PLATINUM



POLISHED COPPER



RUBBED BRONZE



RUST



WARM SILVER



SILVER



STEEL GRAY



ANTIQUE COPPER



RICH GOLD



PALE GOLD



GOLD



FLASH COPPER



RED MAHOGANY



GOLDEN OAK



HICKORY



CHERRY



WALNUT

WE CAN DRILL A HOLE IN THE CENTER OF ANY CEILING MEDALLION

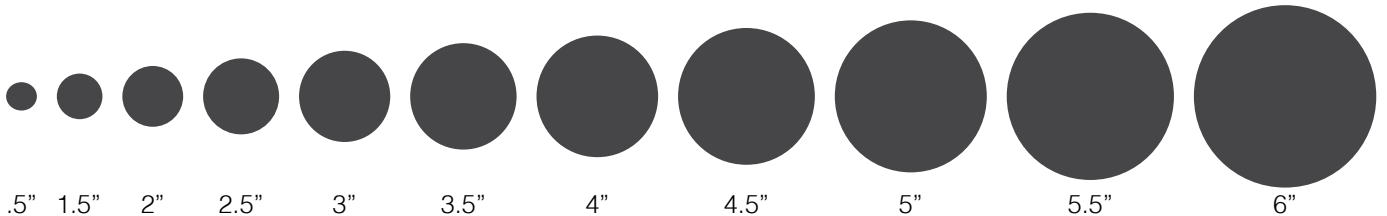

.5" 1.5" 2" 2.5" 3" 3.5" 4" 4.5" 5" 5.5" 6"

CEILING DOMES



DUBLIN

Product ID	OD	RO-D	RO-W
DOME26DU	26 7/8"	3 1/4"	24 1/2"



TRADITIONAL

Product ID	OD	RO-D	RO-W
DOME28TR	28"	4 1/2"	24"



BERKSHIRE

Product ID	OD	RO-D	RO-W
DOME31BE	31 1/8"		



MILTON

Product ID	OD	RO-D	RO-W
DOME31MI	31 7/8"	6 7/8"	25 1/8"

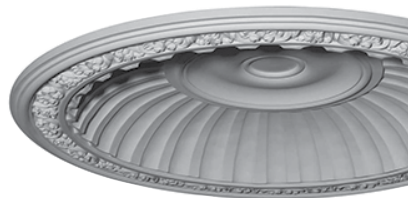

NEXUS

Product ID	OD	RO-D	RO-W
DOME32NE	32 1/2"	4"	26 1/4"



CHESTERFIELD

Product ID	OD	RO-D	RO-W
DOME35CH	35"	6 5/8"	29 1/2"

CEILING DOMES



DEVON

Product ID	OD	RO-D	RO-W
DOME35DE	35 3/8"	2 1/2"	31"

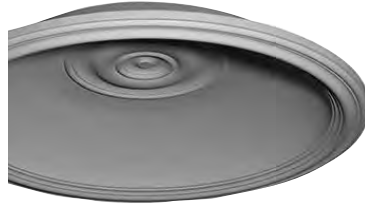

TRADITIONAL

Product ID	OD	RO-D	RO-W
DOME32TR	36 5/8"	6"	32 5/8"



ODESSA

Product ID	OD	RO-D	RO-W
DOME38OD	38 1/2"	7 7/8"	32 1/2"



ARTISAN

Product ID	OD	RO-D	RO-W
DOME38AR	38 5/8"	7 1/2"	35 5/8"



HILLOCK

Product ID	OD	RO-D	RO-W
DOME39HI	39 1/2"	9 1/2"	35"



MILTON

Product ID	OD	RO-D	RO-W
DOME39MI	39 3/8"	4"	33 1/2"



HAMILTON

Product ID	OD	RO-D	RO-W
DOME42HA	42 7/8"	9 1/4"	36 1/2"



EDWARDS

Product ID	OD	RO-D	RO-W
DOME44ED	44 1/8"	8 7/8"	36 1/2"



SMOOTH

Product ID	OD	RO-D	RO-W
DOME44SM	44 1/8"	7 3/4"	40"



DEVON

Product ID	OD	RO-D	RO-W
DOME44X35DE	44"	3 1/4"	40" x 31"



BENSON

Product ID	OD	RO-D	RO-W
DOME46BE	45 5/8"	8"	41"



CLAREMONT

Product ID	OD	RO-D	RO-W
DOME47CL	47 3/8"	10 1/2"	39"

CEILING DOMES



DEVON

Product ID	OD	RO-D	RO-W
DOME47DE	47 3/8"	3 3/4"	42"



MILTON

Product ID	OD	RO-D	RO-W
DOME47MI	47"	5"	41"

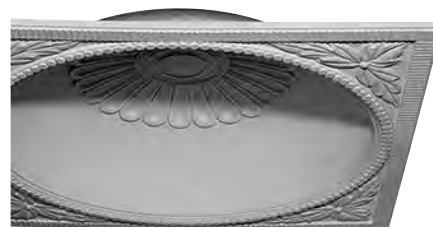

SALEM

Product ID	OD	RO-D	RO-W
DOME47SA	47 1/8"	9 1/8"	44 1/8"



STOCKPORT

Product ID	OD	RO-D	RO-W
DOME47ST	47 1/4"	5 1/4"	41"



ANDREA

Product ID	OD	RO-D	RO-W
DOME47AN	47 3/8"	8"	42 1/2"



DUBLIN

Product ID	OD	RO-D	RO-W
DOME51DU	50 7/8"	7"	49"



HILLSBOROUGH

Product ID	OD	RO-D	RO-W
DOME51HI	51 1/8"	12"	45 1/2"



BEDFORD

Product ID	OD	RO-D	RO-W
DOME53BE	53 7/8"	9 1/4"	48"



ARTISAN

Product ID	OD	RO-D	RO-W
DOME50AR	50 3/8"	9"	46 1/2"



VADUZ

Product ID	OD	RO-D	RO-W
DOME57VA	57 1/8"	9"	50"



MEDWAY

Product ID	OD	RO-D	RO-W
DOME58ME	58 1/4"	9 7/8"	67 3/4"



FLORAL

Product ID	OD	RO-D	RO-W
DOME59FL	59"	10"	51"

CEILING DOMES



SUSSEX

Product ID	OD	RO-D	RO-W
DOME59SU	59"	9"	52"



DUBLIN

Product ID	OD	RO-D	RO-W
DOME59DU	59 1/4"	9"	51 1/4"



CLAREMONT

Product ID	OD	RO-D	RO-W
DOME60CL	60 3/4"	14"	53"



ASHLEY

Product ID	OD	RO-D	RO-W
DOME63AS	63"	9 1/2"	70 7/8"



ARTISAN

Product ID	OD	RO-D	RO-W
DOME62AR	63 5/8"	13 3/8"	62"



ARTISAN

Product ID	OD	RO-D	RO-W
DOME74AR	74"	19 1/2"	73 1/2"



HILLSBOROUGH

Product ID	OD	RO-D	RO-W
DOME79HI	79 1/2"	17 1/2"	77 1/2"



ARTISAN

Product ID	OD	RO-D	RO-W
DOME87AR	87"	24"	85"

S U R F A C E M O U N T



ASHFORD

Product ID	OD	ID	W
DOME28AS	28 7/8"	22"	4 1/4"



BEDFORD

Product ID	OD	ID	W
DOME34BE	34 1/2"	25"	4"



TRADITIONAL

Product ID	OD	ID	W
DOME37TR	37 3/8"	26 1/2"	4 1/2"

CEILING RINGS

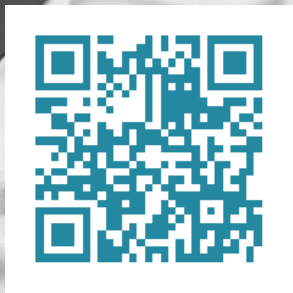

WHOLE
complete circle

QUARTER
1/4 of a circle

The complex block contains two circular diagrams. The first diagram is a solid teal circle with the word "WHOLE" in the center and "complete circle" below it. The second diagram is a teal circle with only one quadrant shaded, with the word "QUARTER" in the center and "1/4 of a circle" below it.

CEILING RINGS

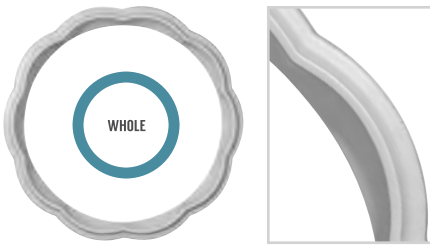

WIGAN

Product ID	OD	ID	W	P
CR07WG	7 3/4"	6 1/4"	3/4"	1/2"

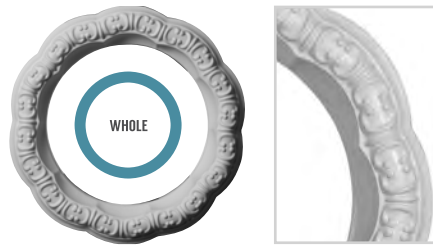

SWINDON

Product ID	OD	ID	W	P
CR09SW	10"	6 5/8"	1 5/8"	1 1/4"

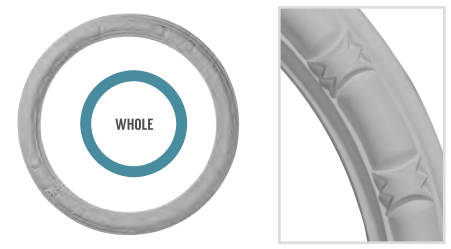

EGG & DART

Product ID	OD	ID	W	P
CR21EG	21 3/8"	16 7/8"	2 1/4"	1"

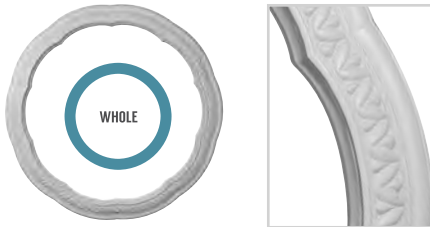

RAYMOND

Product ID	OD	ID	W	P
CR22RA	22 1/4"	17 1/4"	2 1/2"	1 1/2"

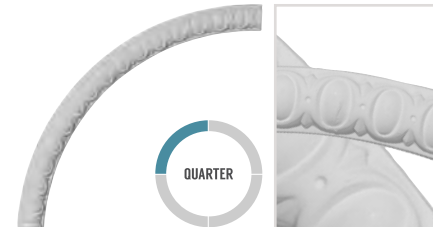

MIDDLESBOROUGH EGG & DART

Product ID	OD	ID	W	P
CR22MD	22 3/4"	20 1/4"	1 1/4"	1/2"

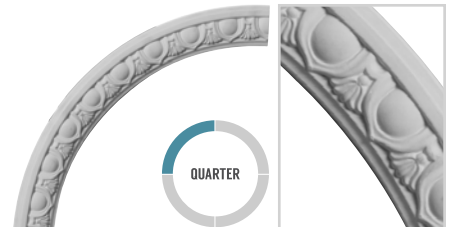

EGG & DART

Product ID	OD	ID	W	P
CR23EG	23 3/4"	19 3/4"	2"	3/4"

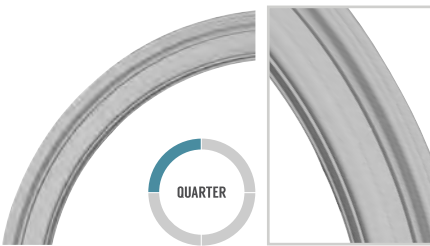

CLAREMONT

Product ID	OD	ID	W	P
CR23CL	24"	20"	2"	7/8"

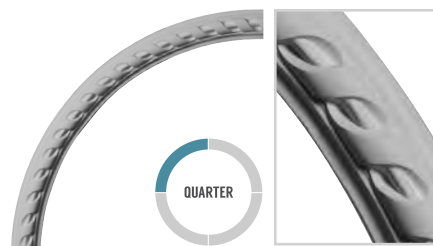

MEDWAY

Product ID	OD	ID	W	P
CR15ME	26 3/4"	23 1/2"	1 5/8"	3/4"

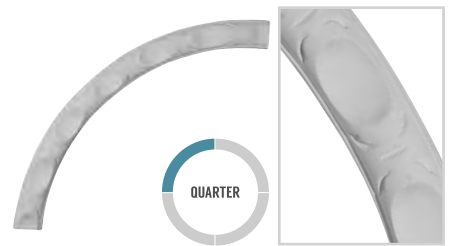

ORRINGTON

Product ID	OD	ID	W	P
CR28OR	28 1/2"	25"	1 3/4"	3/4"

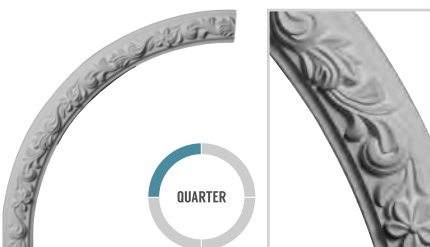

KENT

Product ID	OD	ID	W	P
CR13KE	28 3/4"	24 3/4"	2"	1"

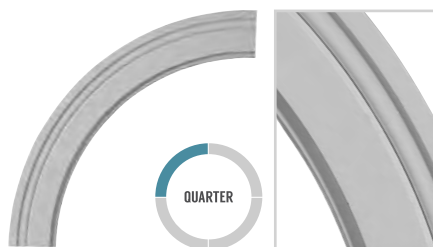

MONIQUE

Product ID	OD	ID	W	P
CR29MO	29 3/4"	23 3/4"	3"	3/8"

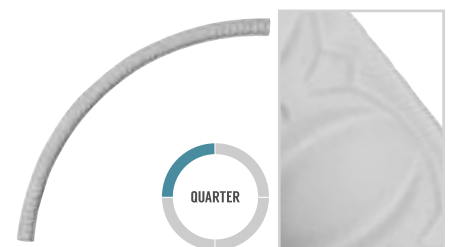

MIDDLESBOROUGH EGG & DART

Product ID	OD	ID	W	P
CR34MD	33 1/2"	31"	1 1/4"	1/2"

IMPORTANT: each section of the ceiling ring will need to be field trimmed and fitted together to make a complete circle

WIDTH

HEIGHT

PROJECTION

CEILING RINGS

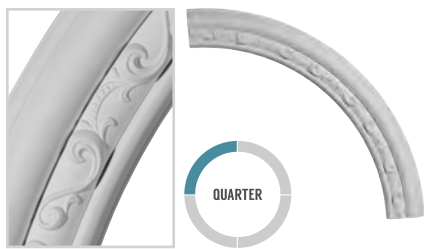

WATFORD

Product ID	OD	ID	W	P
CR35WA	36"	29 1/2"	3 1/4"	1"

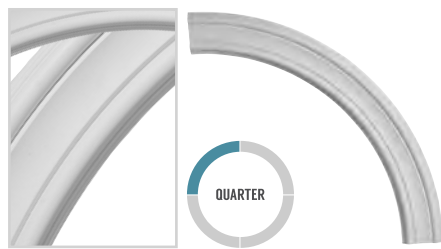

PIERCED

Product ID	OD	ID	W	P
CR35PI	36 1/2"	30 1/4"	3 1/8"	3/4"



OXFORD

Product ID	OD	ID	W	P
CR38OX	38 1/2"	35 1/4"	1 5/8"	3/4"

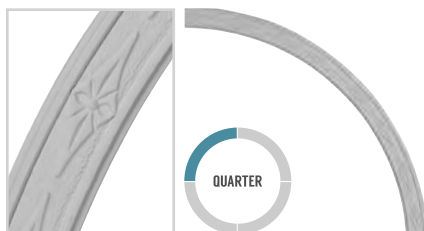

SOFIA

Product ID	OD	ID	W	P
CR39SI	39"	35 1/2"	1 3/4"	1/2"

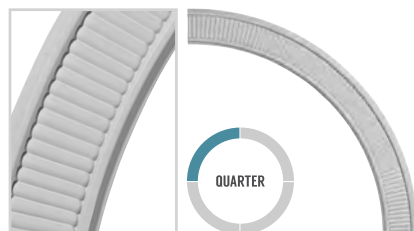

NEVIO

Product ID	OD	ID	W	P
CR39NE	39 1/2"	33 1/4"	3 1/8"	5/8"

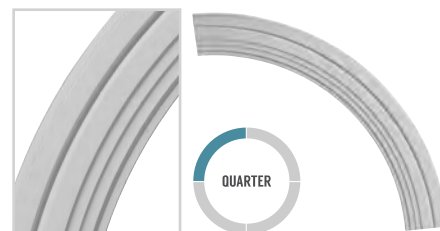

DEVON

Product ID	OD	ID	W	P
CR39DE	40 1/2"	33 1/4"	3 5/8"	1 1/8"

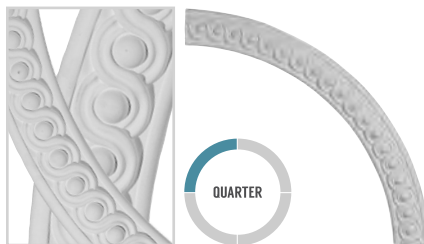

HILLSBOROUGH RUNNING COIN

Product ID	OD	ID	W	P
CR41HI	40 1/4"	34"	3 1/8"	3/4"

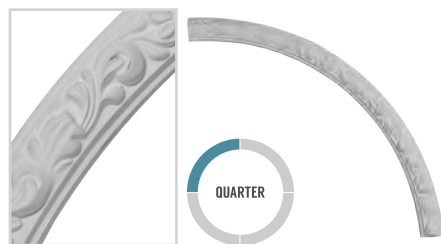

SUSSEX

Product ID	OD	ID	W	P
CR39SU	40"	36"	2"	7/8"

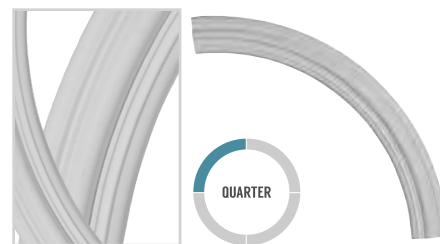

TRADITIONAL

Product ID	OD	ID	W	P
CR41TR	41 3/4"	35 1/4"	3 1/4"	3/4"

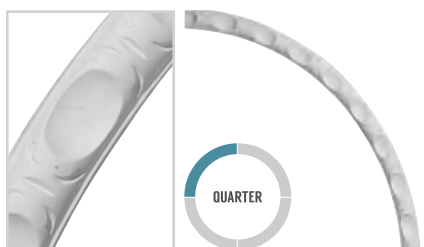

ORRINGTON

Product ID	OD	ID	W	P
CR42OR	41 7/8"	38 3/8"	1 3/4"	5/8"



FLOWER

Product ID	OD	ID	W	P
CR41FL	41"	34 1/4"	3 3/8"	3/4"



ROSE

Product ID	OD	ID	W	P
CR41RO	42 1/2"	36"	3 1/4"	3/4"

CEILING RINGS

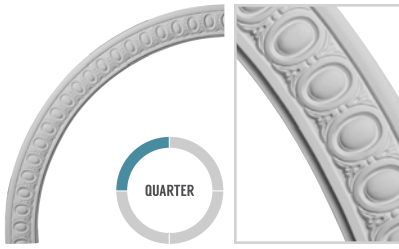

EGG & DART

Product ID	OD	ID	W	P
CR20EG	42"	36"	3"	3/4"

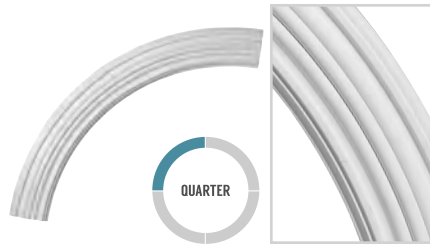

KENT

Product ID	OD	ID	W	P
CR39KE	43 1/4"	35 1/2"	3 7/8"	1"

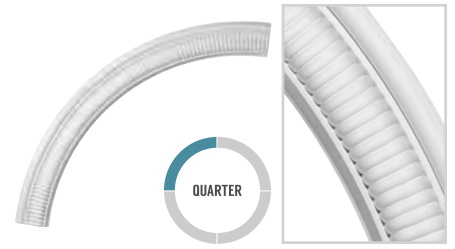

ELSINORE

Product ID	OD	ID	W	P
CR43EL	43 1/4"	36 3/4"	3 1/4"	1/4"

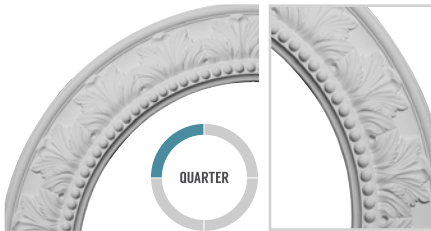

WAKEFIELD

Product ID	OD	ID	W	P
CR44WA	44"	30 1/4"	44"	2"

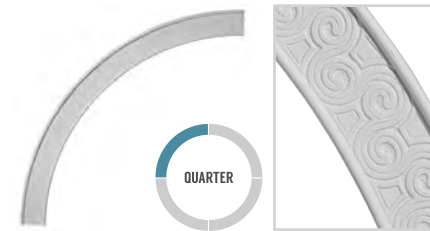

BEDFORD

Product ID	OD	ID	W	P
CR44BE	44 1/2"	39 1/4"	2 3/4"	5/8"

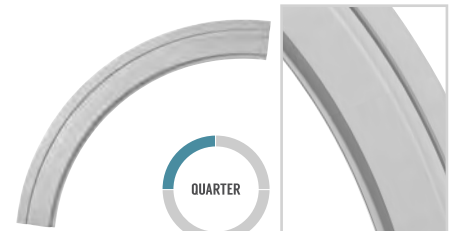

MONIQUE

Product ID	OD	ID	W	P
CR47MO	47 1/2"	39 1/4"	4 1/8"	7/8"

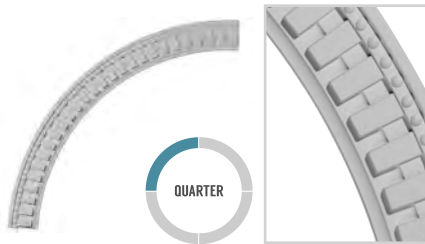

DENTIL AND BEAD

Product ID	OD	ID	W	P
CR47DT	47"	40 1/2"	3 1/4"	1 1/8"

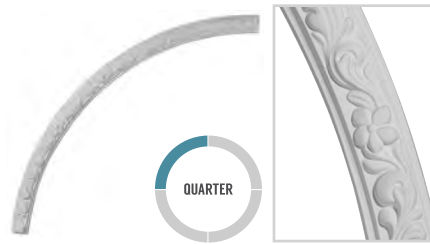

SUSSEX

Product ID	OD	ID	W	P
CR49SU	49 1/4"	45 1/4"	2"	7/8"

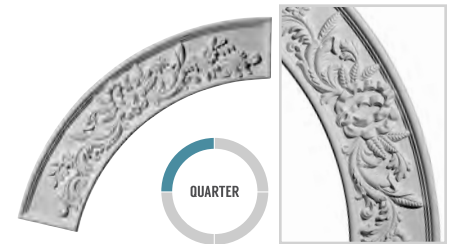

TOMANGO

Product ID	OD	ID	W	P
CR49TO	49 1/4"	37 1/4"	6"	1 1/4"

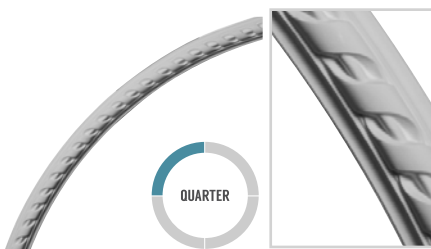

MEDWAY

Product ID	OD	ID	W	P
CR25ME	50"	47"	1 1/2"	3/4"

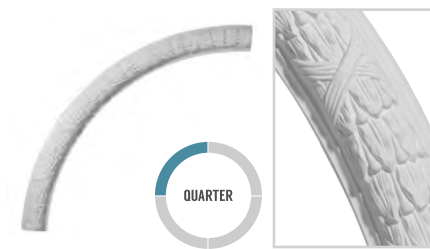

DUBLIN

Product ID	OD	ID	W	P
CR50DU	50"	44"	3"	1 1/4"

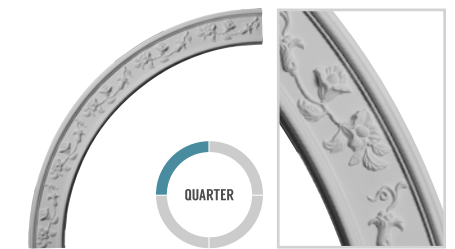

FLORAL

Product ID	OD	ID	W	P
CR25FL	51 1/4"	43 1/4"	4"	7/8"

IMPORTANT: each section of the ceiling ring will need to be field trimmed and fitted together to make a complete circle

WIDTH

HEIGHT

PROJECTION

CEILING RINGS



MARCELLA

Product ID	OD	ID	W	P
CR51MA	51"	43"	4"	7/8"

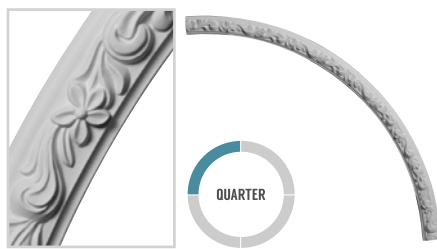

KENT

Product ID	OD	ID	W	P
CR25KE	52"	48"	2"	1"



OXFORD

Product ID	OD	ID	W	P
CR52OX	52"	47"	2"	3/4"

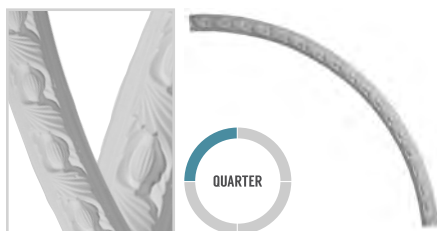

MILTON

Product ID	OD	ID	W	P
CR55MI	54 1/4"	50 1/4"	2"	3/4"



FLOWER

Product ID	OD	ID	W	P
CR59FL	55 3/4"	52 1/4"	3 1/4"	3/4"

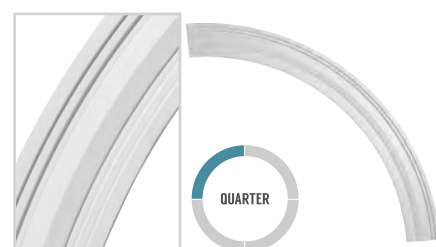

FELIX

Product ID	OD	ID	W	P
CR55FX	55 3/8"	47 3/8"	4"	7/8"



**PAIR YOUR
MEDALLION
WITH A
CEILING RING
TO CREATE A
UNIQUE LOOK!**

CEILING RINGS

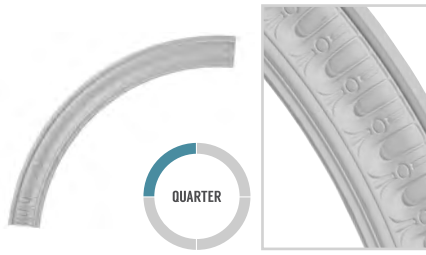

SEQUENTIAL

Product ID	OD	ID	W	P
CR55SQ	55"	46 3/4"	4 1/8"	1 1/8"

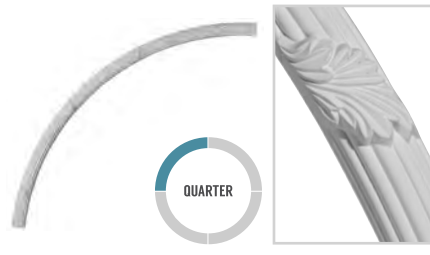

SEVILLE

Product ID	OD	ID	W	P
CR57SE	57 1/4"	53 3/4"	1 3/4"	1 1/4"

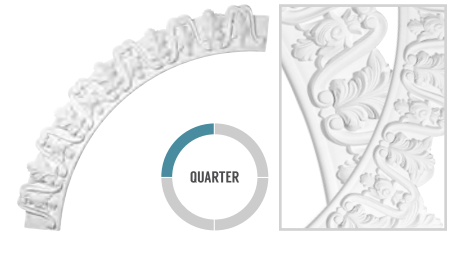

TIRANA

Product ID	OD	ID	W	P
CR57TI	57 3/8"	46 1/8"	5 5/8"	1"

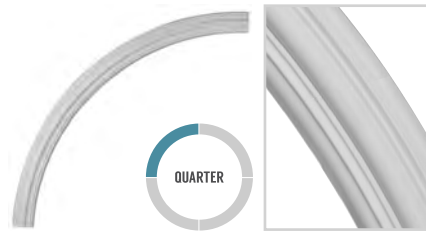

POMPEII

Product ID	OD	ID	W	P
CR59PO	58 5/8"	53 5/8"	2 1/2"	7/8"

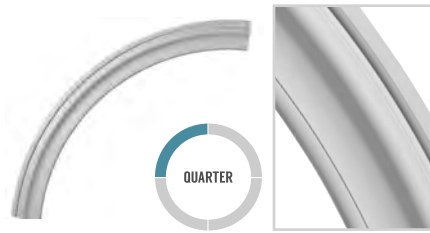

DYLAN

Product ID	OD	ID	W	P
CR59DY	59 1/2"	51 1/2"	4"	1 1/2"

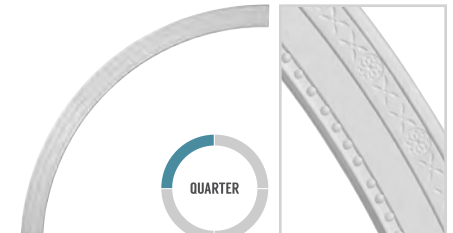

TRALEE

Product ID	OD	ID	W	P
CR59TE	59 1/2"	53"	2 3/4"	1/2"

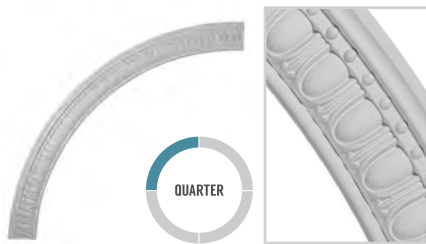

ARTIS EGG & DART

Product ID	OD	ID	W	P
CR59AR	59"	51 3/4"	3 5/8"	1"

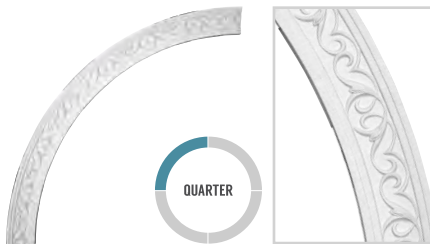

KENT

Product ID	OD	ID	W	P
CR59KE	59"	52"		3/4"

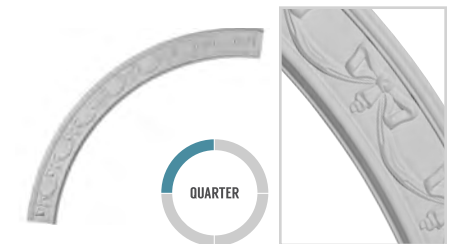

FEDERAL

Product ID	OD	ID	W	P
CR67FE	63"	54 1/4"	4 3/8"	3/4"

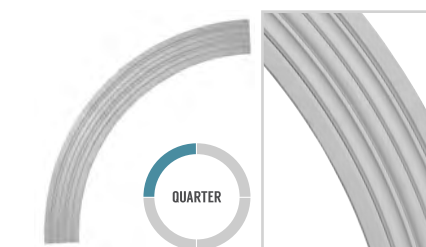

EDINBURGH

Product ID	OD	ID	W	P
CR63ED	63 1/2"	53 3/8"	5"	3/4"

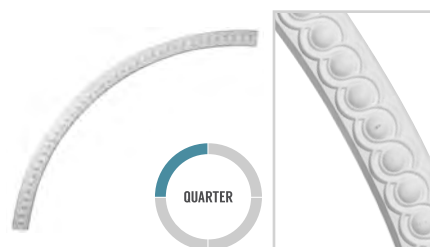

HILLSBOROUGH RUNNING COIN

Product ID	OD	ID	W	P
CR63HI	63 1/2"	59"	2 1/4"	3/4"



CORNELIA

Product ID	OD	ID	W	P
CR64CN	63 3/4"	55 7/8"	4"	3/4"

IMPORTANT: each section of the ceiling ring will need to be field trimmed and fitted together to make a complete circle

WIDTH

HEIGHT

PROJECTION

CEILING RINGS

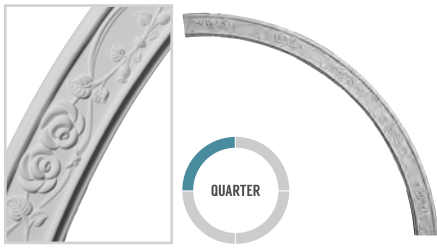

ROSE

Product ID	OD	ID	W	P
CR32RO	64"	57 1/2"	3 1/4"	7/8"

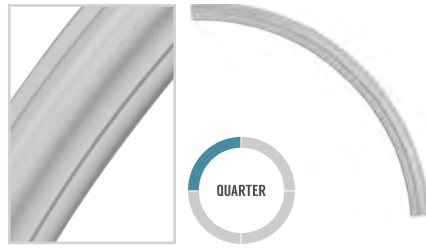

TRADITIONAL

Product ID	OD	ID	W	P
CR64TR	64 1/2"	58"	3 1/4"	1"

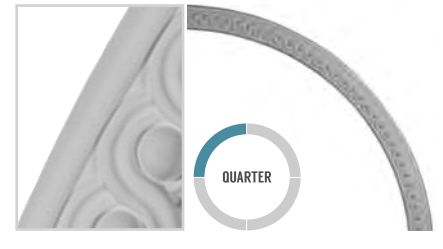

HILLSBOROUGH

Product ID	OD	ID	W	P
CR65HI	64 1/2"	58"	3 1/4"	1"

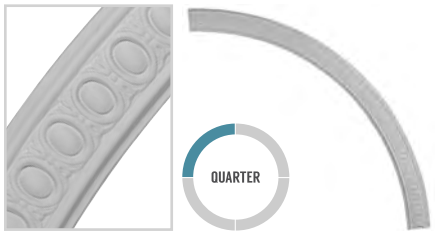

CAPUTO EGG & DART

Product ID	OD	ID	W	P
CR64CA	64 3/4"	58 1/4"	3 1/4"	3/4"

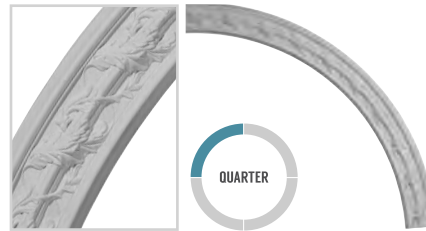

SOUTHAMPTON ACANTHUS LEAF

Product ID	OD	ID	W	P
CR67SO	66 3/4"	58"	4 3/8"	1"

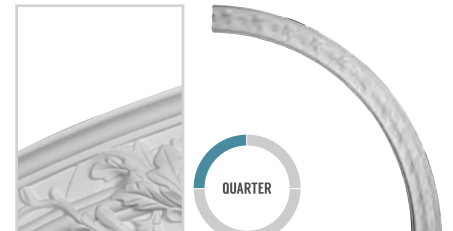

TRISTAN

Product ID	OD	ID	W	P
CR67TR	67 3/8"	58 5/8"	8 3/4"	7/8"

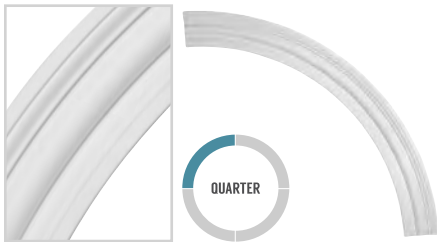

BRADFORD

Product ID	OD	ID	W	P
CR67BR	68"	58"	5"	1"

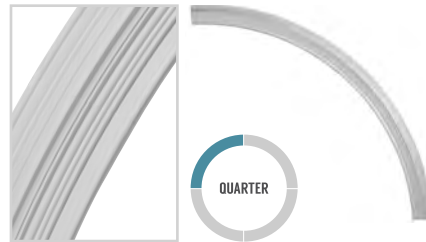

CHESTERFIELD

Product ID	OD	ID	W	P
CR69CH	69"	62 3/4"	3 1/8"	1 1/4"

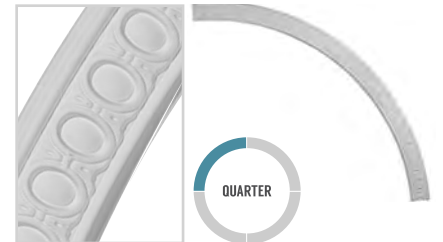

CAPUTO EGG & DART

Product ID	OD	ID	W	P
CR70CA	70"	63 1/2"	3 1/4"	5/8"

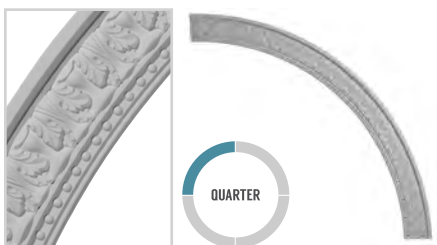

PALMETTO

Product ID	OD	ID	W	P
CR70PM	71 1/4"	62 3/4"	4 1/4"	1 3/8"

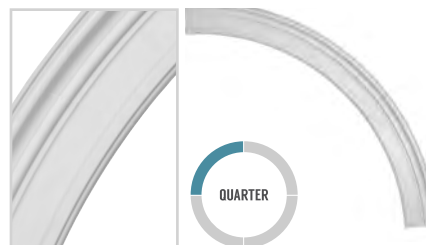

BEDFORD

Product ID	OD	ID	W	P
CR70BE	71 3/8"	61 3/8"	5"	1 5/8"

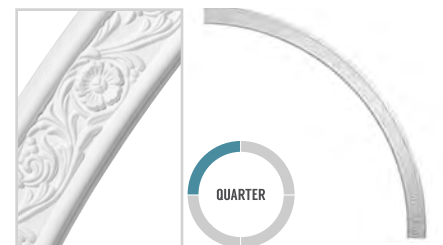

MEDWAY

Product ID	OD	ID	W	P
CR73ME	74 3/4"	68 1/2"	3 1/8"	1/2"

CEILING RINGS



FLORAL

Product ID	OD	ID	W	P
CR37FL	76"	68"	4"	7/8"

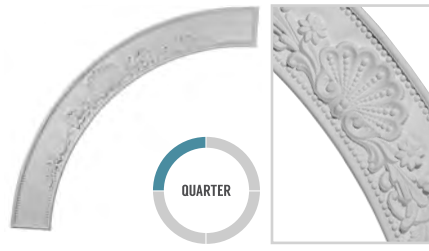

SHELL

Product ID	OD	ID	W	P
CR78SH	78 1/8"	64 7/8"	6 5/8"	1"

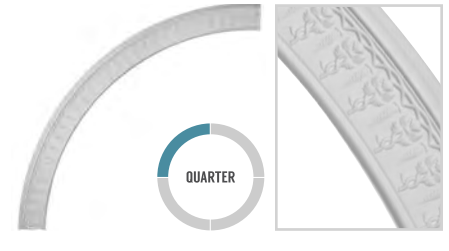

SPIRAL

Product ID	OD	ID	W	P
CR78SP	79 1/2"	70 1/4"	4 5/8"	1 1/8"

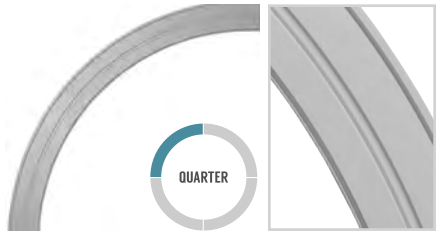

MILTON

Product ID	OD	ID	W	P
CR78MI	84 3/4"	74 1/4"	5 1/4"	1"

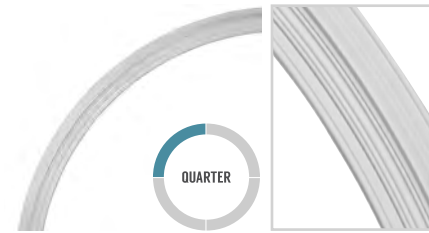

LEGACY

Product ID	OD	ID	W	P
CR86LE	87 1/2"	79 1/4"	4 1/8"	1 1/2"



TRADITIONAL

Product ID	OD	ID	W	P
CR96TR	93 1/2"	77 3/4"	7 7/8"	2 3/4"



IMPORTANT: each section of the ceiling ring will need to be field trimmed and fitted together to make a complete circle

WIDTH | HEIGHT | PROJECTION

CEILING TILES



DENTIL

Product ID	W	H	P
CT24X24DE	23 3/4"	23 3/4"	1 5/8"



FLORAL

Product ID	W	H	P
CT24X24FL	23 7/8"	23 7/8"	2 1/2"



NICOLE

Product ID	W	H	P
CT24X24NI	23 7/8"	23 7/8"	2 1/2"



BRADFORD

Product ID	W	H	P
CT24X24BR	23 7/8"	23 7/8"	3"



SHELL

Product ID	W	H	P
CT24X24SH	23 7/8"	23 7/8"	5 1/2"



ASHFORD

Product ID	W	H	P
CT24X24AS	23 7/8"	23 7/8"	3"

CEILING TILES



CORNELIA

Product ID	W	H	P
CT24X24CN	23 7/8"	23 7/8"	2 1/2"



TRADITIONAL

Product ID	W	H	P
CT24X24TR	23 7/8"	23 7/8"	2 1/2"



LOGAN

Product ID	W	H	P
CT24X24LO	24"	24"	2 7/8"



CLASSIC

Product ID	W	H	P
CT24X24CL	24"	24"	2 7/8"



EGG & DART

Product ID	W	H	P
CT24X24EG	24"	24"	2 3/8"



COLONIAL

Product ID	W	H	P
CT24X24CO	24"	24"	2 7/8"



EDWARDS

Product ID	W	H	P
CT24X24ED	24"	24"	2 3/8"



KINSLEY

Product ID	W	H	P
CT24X24KI	24"	24"	2 3/8"



ROYAL

Product ID	W	H	P
CT24X24RO	24"	24"	2 7/8"



STAR

Product ID	W	H	P
CT24X24ST	24"	24"	2 7/8"



QUATRO

Product ID	W	H	P
CM24QU	23 3/4"	23 3/4"	1 5/8"



CLASSIC

Product ID	W	H	P
CT24CL	23 3/4"	23 3/4"	1 5/8"

BRACKETS & CORBELS





SOUTHAMPTON

Product ID	W	H	D
BKT11X11X00SO	3/4"	11"	11"



SWANSEA

Product ID	W	H	D
BKT11X11X00SW	7/8"	12"	11"



VERSAILLES

Product ID	W	H	D
BKT01X11X12VE	1"	12 1/4"	11 1/2"



WAKEFIELD

Product ID	W	H	D
BKT12X12X01WA	1"	12"	12"



CHESTERFIELD

Product ID	W	H	D
BKT13X14X01CH	1"	14 5/8"	13"



ASHFORD

Product ID	W	H	D
BKT18X17X01AS	1 1/4"	18"	17"

TRADITIONAL

Product ID	W	H	D
COR02X06X10TR	2 7/8"	10"	5 7/8"
COR02X07X14TR	2 7/8"	14"	7 1/2"
COR04X06X07TR	4 1/2"	7 1/4"	5 7/8"
COR04X06X10TR	4 1/2"	10"	5 7/8"
COR04X07X10TR	4 1/2"	10"	7 1/2"
COR04X07X14TR	4 1/2"	14"	7 1/2"

OVER

200

CORBELS & BRACKETS



BRACKETS



STOCKPORT

Product ID	W	H	D
BKT03X05X05ST	3"	5 1/2"	5 1/2"
BKT03X05X07ST	3"	7 1/4"	5 1/2"
BKT03X07X07ST	3"	7 1/4"	7 1/4"
BKT03X07X09ST	3"	9"	7 1/4"
BKT03X05X05TI	3 1/2"	5 1/2"	5 1/2"
BKT05X05X05ST	5"	5 1/2"	5 1/2"
BKT05X05X07ST	5"	7 1/4"	5 1/2"
BKT05X07X07ST	5"	7 1/4"	7 1/4"
BKT05X07X09ST	5"	9"	7 1/4"
BKT06X07X05DU	6"	5"	7 1/2"
BKT07X05X05ST	7 1/4"	5 1/2"	5 1/2"
BKT07X07X05ST	7 1/4"	7 1/4"	5 1/2"
BKT07X07X07ST	7 1/4"	7 1/4"	7 1/4"
BKT07X07X09ST	7 1/4"	9"	7 1/4"

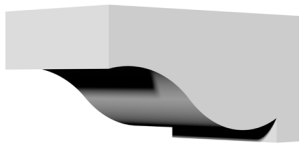

TEMPLE

Product ID	W	H	D
BKT06X10X05TE	6"	5 1/4"	10 3/4"



WIRRAL

Product ID	W	H	D
BKT14X15X04WI	4"	15 3/4"	14"



FEDERAL

Product ID	W	H	D
BKT03X10X11FE	3"	11 1/4"	10 1/2"



TYRONE

Product ID	W	H	D
BKT02X11X17TY	2 7/8"	17"	11"



DOVER

Product ID	W	H	D
BKT07X11X05DR	5 1/2"	7 1/4"	11 3/4"



CLAREMONT

Product ID	W	H	D
BKT16X20X04CL	4"	20"	16"



REECE

Product ID	W	H	D
BKT05X14X12RE	5"	12 1/2"	14 3/4"

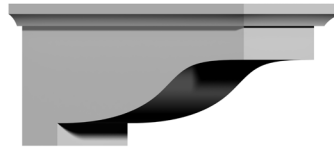

DUBLIN

Product ID	W	H	D
BKT13X06X05DU	6"	5 7/8"	13"



BEDFORD

Product ID	W	H	D
BKT06X12X04BE	4 1/4"	12"	6 1/2"



NEXUS LEFT

Product ID	W	H	D
BKT07X04X06NE-L	7 1/2"	4"	6 1/4"



NEXUS RIGHT

Product ID	W	H	D
BKT07X04X06NE-R	7 1/2"	4"	6 1/4"



NIOBE

Product ID	W	H	D
BKT10X12X07NI	7 1/4"	10 1/8"	12"

DUBLIN

Product ID	W	H	D
BKT07X04X04SU	4 5/8"	4"	7 1/2"
BKT09X05X05DU	5 5/8"	5 3/4"	9 3/8"
BKT06X05X04WA	6"	4 5/8"	6 1/4"
BKT06X11X06DU	6"	6"	11 1/2"
BKT07X07X05DU	7"	5"	7 1/2"
BKT07X09X05DU	7"	5 1/2"	9 1/2"
BKT07X04X04LA	4 1/2"	4 1/8"	7 1/2"
BKT07X03X05LU	7 3/4"	3 1/2"	5 1/8"
BKT08X11X06DU	8"	6"	11 1/2"



BRACKETS



EDWARDS

Product ID	W	H	D
BKT06X10X02ED	6"	10 3/8"	2"



IMPERIAL

Product ID	W	H	D
BKT16X16X04IM	4"	16"	16"
BKT20X20X04IM	4"	20"	20"
BKT24X24X04IM	4"	24"	24"
BKT30X30X04IM	4"	30"	30"
BKT36X36X04IM	4"	36"	36"
BKT24X24X06IM	6"	24"	24"
BKT30X30X06IM	6"	30"	30"
BKT36X36X06IM	6"	36"	36"



GENEVIEVE

Product ID	W	H	D
COR12X02X07GE	2 1/8"	12 1/8"	7 7/8"
COR18X03X12GE	3 1/4"	18 1/4"	12 1/8"



TRADITIONAL

Product ID	W	H	D
BKT03X07X10TR	3"	10 5/8"	7 5/8"
BKT03X15X19TR	3 1/2"	19"	15"



EMERY

Product ID	W	H	D
BKT03X28X30EM	3 1/2"	30"	28"

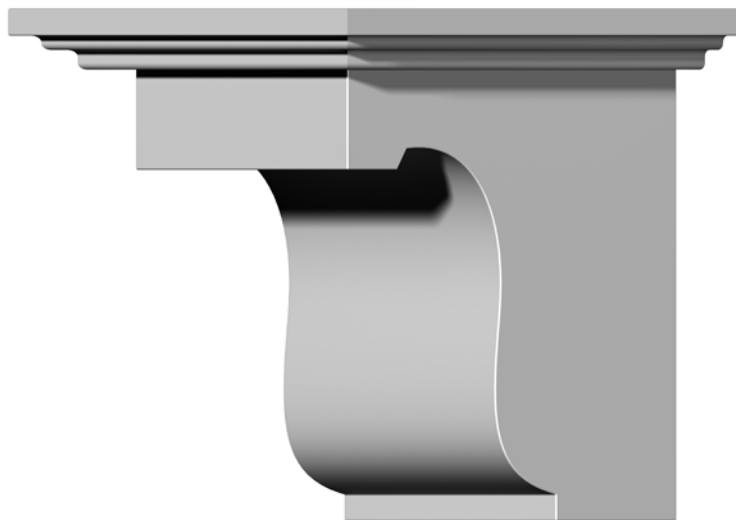

LEGACY

Product ID	W	H	D
BKT06X06X02LE	2 7/8"	6"	6"
BKT04X06X06LE	4"	6"	6"
BKT06X06X04LE	4 7/8"	6"	6"
BKT08X08X02LE	2 7/8"	8"	8"
BKT08X08X04LE	4 7/8"	8"	8"
BKT10X10X04LE	4 7/8"	10"	10"
BKT06X06X06LE	6 7/8"	6"	6"
BKT08X08X06LE	6 7/8"	8"	8"
BKT10X10X06LE	6 7/8"	10"	10"
BKT12X12X06LE	6 7/8"	12"	12"
BKT08X08X08LE	8 7/8"	8"	8"
BKT10X10X08LE	8 7/8"	10"	10"
BKT12X12X08LE	8 7/8"	12"	12"

LEGACY

Product ID	W	H	D
BKT12X12X03LE	3"	12"	12"
BKT10X10X03LE	3"	10"	10"
BKT14X14X03LE	3 1/2"	14"	14"
BKT16X16X03LE	3 1/2"	16"	16"
BKT18X18X03LE	3 1/2"	18"	18"
BKT12X12X05LE	5 1/2"	12"	12"
BKT14X14X05LE	5 1/2"	14"	14"
BKT16X16X05LE	5 1/2"	16"	16"
BKT18X18X05LE	5 1/2"	18"	18"
BKT24X24X05LE	5 1/2"	24"	24"
BKT08X30X30LE	8"	30"	30"



KENT

Product ID	W	H	D
COR17X03X08KE	17 1/4"	8 5/8"	3 5/8"



GIANA

Product ID	W	H	D
BKT11X06X05GI	6 1/4"	5 7/8"	11 3/4"



FEDERAL

Product ID	W	H	D
BKT07X04X05FE	7 5/8"	4"	5 1/4"



ABERDEEN

Product ID	W	H	D
BKT02X09X16AB	2 3/4"	16"	9 3/4"



MARCELLA

Product ID	W	H	D
COR03X09X14MA	3 3/4"	14 1/2"	9 5/8"



PIEDMONT

Product ID	W	H	D
COR06X11X16PE	6"	16 1/4"	11"

BRACKETS

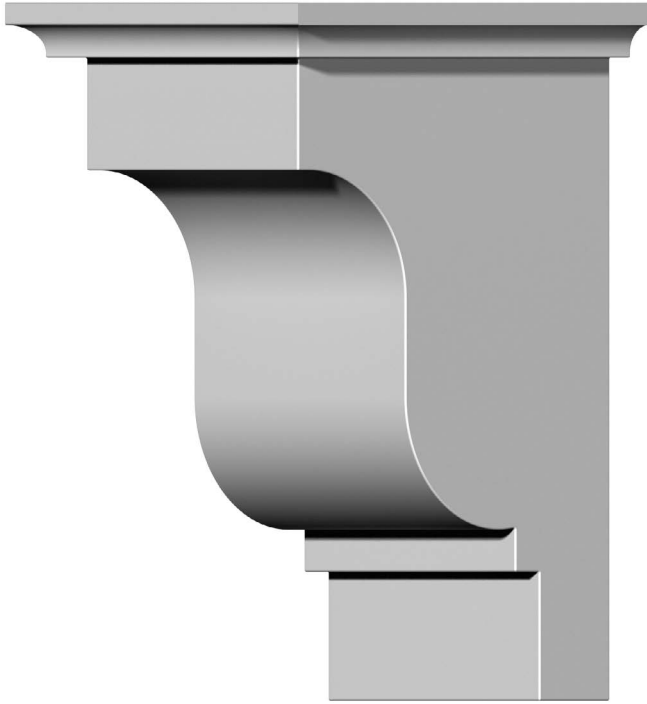

EDINBURGH

Product ID	W	H	D
BKT03X07X05ED	3 1/2"	5"	7"
BKT03X09X07ED	3 1/2"	7"	9"
BKT04X10X10ED	4 1/8"	10 1/2"	10 1/2"
BKT10X16X04ED	4 1/8"	10 1/2"	16 1/4"



DIANE

Product ID	W	H	D
BKT03X04X08DI	3 1/2"	8"	4 1/4"
BKT05X10X03DI	4"	10"	5 1/4"
BKT04X06X12DI	4 1/2"	12"	6 1/2"
BKT05X07X14DI	5"	14"	7"



GIANA

Product ID	W	H	D
COR06X11X20GI	6 1/2"	20"	11"
COR06X14X26GI	6 1/2"	26"	14 1/2"
COR08X22X26GI	8 1/2"	26"	22 1/2"

ASHFORD

Product ID	W	H	D
BKT02X11X11AS	2"	11 7/8"	11 7/8"
BKT02X15X15AS	2"	15 7/8"	15 7/8"
BKT02X13X13AS	2"	13 7/8"	13 7/8"

WE ALSO HAVE ROUGH SAWN & CARVED WOOD BRACKETS!



RICHMOND

Product ID	W	H	D
BKT04X12X12RI	4"	12"	12"
BKT04X12X16RI	4"	16"	12"
BKT04X15X16RI	4"	16"	15"
BKT04X18X24RI	4"	24"	18 5/8"

WIGAN

Product ID	W	H	D
BKT03X04X05WG	3 1/2"	5"	4"
BKT03X04X07WG	3 1/2"	7"	4"
BKT05X06X04WG	4 1/2"	6"	6"
BKT05X04X08WG	5 1/4"	8"	4 1/2"
BKT05X04X10WG	5 1/4"	10"	4 1/2"
BKT06X06X08WG	6"	8"	6"
BKT06X06X12WG	6"	12"	6"



CORBELS



DEVON

Product ID

COR02X02X04DE

W	H	D
2 1/4"	4 1/4"	2 1/4"



ALEXANDRIA

Product ID

COR02X01X03AL

W	H	D
2 5/8"	3 5/8"	1 3/8"



ODESSA

Product ID

COR02X01X03OD

W	H	D
2 5/8"	3 5/8"	1 3/8"

CORBELS



GRANADA

Product ID	W	H	D
COR02X01X05GR	2 3/4"	5 1/2"	1 5/8"



HELENE

Product ID	W	H	D
COR02X01X04HE	2 7/8"	4 3/8"	1 1/2"



VALLETA

Product ID	W	H	D
COR02X01X04VL	2 7/8"	4 3/8"	1 5/8"



ORION

Product ID	W	H	D
COR03X01X04OR	3"	4 7/8"	1 1/2"



HAMPSHIRE

Product ID	W	H	D
COR03X01X08HA	3"	8 1/2"	1 7/8"



OXFORD

Product ID	W	H	D
COR03X05X01OX	3 1/8"	5 1/8"	1 1/2"

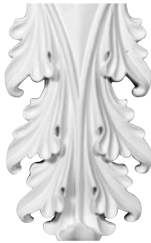

LEAF

Product ID	W	H	D
COR03X01X05LE	3 1/8"	5"	3/4"



NORWICH

Product ID	W	H	D
COR03X02X06NO	3 1/2"	6 1/8"	2 1/4"



APOLLO

Product ID	W	H	D
COR03X02X06AP	3 1/2"	6"	2 3/4"



OXFORD

Product ID	W	H	D
COR03X02X07OX	3 3/8"	7 3/4"	2 1/2"



BALTIMORE

Product ID	W	H	D
COR03X01X04BA	3 1/2"	4 1/8"	1 5/8"



BENSON

Product ID	W	H	D
COR03X02X06BE	3 1/2"	6"	2"

CORBELS



COLE

Product ID	W	H	D
COR03X03X06CO	3 1/2"	6 3/4"	3"



MARIA

Product ID	W	H	D
COR03X02X11MA	3 1/2"	11 5/8"	2 1/2"



LEAF

Product ID	W	H	D
COR04X02X07LE	3 5/8"	7"	2 1/8"



SCROLL

Product ID	W	H	D
COR03X02X06SC	3 5/8"	6 1/8"	2 1/2"



NORWICH

Product ID	W	H	D
COR03X01X07NO	3 3/4"	7 1/8"	1 7/8"



SCROLL LEAF

Product ID	W	H	D
COR03X01X05SC	3 7/8"	5 1/4"	1 1/4"



BALTIMORE

Product ID	W	H	D
COR03X02X05BA	3 7/8"	5 7/8"	2 1/8"



LEGACY

Product ID	W	H	D
COR03X02X05LE	3 7/8"	5 7/8"	2 3/4"



ODESSA

Product ID	W	H	D
COR03X05X27OD	3 7/8"	27"	5 1/4"



HAMPSHIRE

Product ID	W	H	D
COR04X02X09HA	4"	9 5/8"	2 1/8"



DUBLIN

Product ID	W	H	D
COR04X03X05DU	4"	5 5/8"	2 3/4"



DEVON

Product ID	W	H	D
COR04X04X07DE	4"	7 1/2"	4"



LEANDROS

Product ID	W	H	D
COR04X05X03LE	4 1/8"	5 3/4"	3"



BLACKTHORNE

Product ID	W	H	D
COR04X02X05BL	4 1/4"	5 3/4"	2 5/8"



COLE

Product ID	W	H	D
COR04X02X06CO	4 1/4"	6 3/8"	2 3/8"



HAMPSHIRE

Product ID	W	H	D
COR04X02X11HA	4 1/4"	10 7/8"	2 1/2"



CORBELS



NEEDHAM

Product ID	W	H	D
COR04X04X12NE	4 1/4"	12 3/4"	4 3/8"



PALMETTO

Product ID	W	H	D
COR04X02X05PA	4 3/8"	5 5/8"	2 1/2"



REECE

Product ID	W	H	D
COR04X07X03RE	4 3/8"	7 7/8"	3 1/8"

OVER 200 CORBELS & BRACKETS



ASA

Product ID	W	H	D
COR04X01X10AS	4 1/2"	10"	1 3/4"



LEGACY

Product ID	W	H	D
COR04X02X06LE	4 5/8"	6 3/4"	2 3/4"



CHERRY CLUSTER

Product ID	W	H	D
COR04X05X09CH	4 5/8"	9 3/8"	5 1/2"



SCROLL LEAF

Product ID	W	H	D
COR04X05X10SC	4 5/8"	10 3/4"	5 1/4"



TIRANA

Product ID	W	H	D
COR04X03X06TI	4 5/8"	6 3/8"	3"

CORBELS



SALO

Product ID	W	H	D
COR04X03X09SA	4 3/4"	9 3/4"	3 1/8"



TRADITIONAL

Product ID	W	H	D
COR04X06X03TR	4 3/4"	6 3/4"	3 1/2"



WALTZ

Product ID	W	H	D
COR04X06X03WA	4 3/4"	6 1/4"	3 1/8"



REECE

Product ID	W	H	D
COR04X07X14RE	4 3/4"	14"	7 1/2"



FORREST SMALL LEAF

Product ID	W	H	D
COR06X04X03FO	4 3/4"	6 3/4"	3 1/8"



ZEPHYR

Product ID	W	H	D
COR04X03X09ZE	4 3/4"	9 7/8"	3"



DUBLIN

Product ID	W	H	D
COR05X02X05DU	4 5/8"	5 1/2"	2 3/4"



GORLEEN

Product ID	W	H	D
COR04X02X09GO	4 5/8"	9 3/4"	2 5/8"



LEGACY

Product ID	W	H	D
COR12X04X02LE	4 3/4"	12 1/4"	2 3/4"



LEAF

Product ID	W	H	D
COR04X02X15LF	4 7/8"	15 1/4"	2 3/4"



KIRKE

Product ID	W	H	D
COR04X05X09KI	4 7/8"	9 5/8"	5 5/8"



HAMILTON

Product ID	W	H	D
COR04X05X10HA	4 7/8"	10 1/8"	5 1/2"

CORBELS



NICOLE

Product ID	W	H	D
COR05X03X06NI	5"	6 1/4"	3 1/2"



SALEM

Product ID	W	H	D
COR05X02X07SA	5"	7 7/8"	2 1/2"



COLTON

Product ID	W	H	D
COR05X02X09CO	5"	9 3/4"	2 5/8"



ROSE

Product ID	W	H	D
COR05X02X08RO	5 1/4"	8 1/8"	2 3/4"

CORBELS



ATTICA

Product ID	W	H	D
COR05X03X08AT	5"	8 3/8"	3 5/8"



SALEM

Product ID	W	H	D
COR05X06X14SA	5"	14"	6"



DEVON

Product ID	W	H	D
COR05X05X09DE	5 1/4"	9 1/2"	5 1/4"



EDINBURGH

Product ID	W	H	D
COR05X03X08ED	5 1/4"	8 3/8"	3 1/4"



DAMON

Product ID	W	H	D
COR05X05X12DA	5 1/4"	12 1/4"	5 3/8"



HILLSBOROUGH

Product ID	W	H	D
COR05X02X07HI	5 3/8"	7 3/4"	2 1/2"



ACANTHUS

Product ID	W	H	D
COR05X04X15AC	5 3/8"	15 1/2"	4 1/8"



ACANTHUS

Product ID	W	H	D
COR05X10X05AC	5 1/2"	10 5/8"	5 3/8"



EMERY

Product ID	W	H	D
COR05X02X08EM	5 1/2"	8 1/4"	2 3/4"



ADONIS

Product ID	W	H	D
COR05X04X09AD	5 1/2"	9"	4 1/2"



ROYAL

Product ID	W	H	D
COR05X02X09MO	5 1/2"	9 3/8"	2 3/4"



BREMEN

Product ID	W	H	D
COR05X03X09BR	5 1/2"	9 3/4"	3 7/8"

CORBELS



ODESSA

Product ID	W	H	D
COR05X04X12OD	5 3/4"	12 3/8"	4 3/4"



STOCKPORT

Product ID	W	H	D
COR05X04X17ST	5 7/8"	17 3/4"	4 1/4"



DEVON

Product ID	W	H	D
COR06X07X13DE	6"	13 1/4"	7"



OLIVE

Product ID	W	H	D
COR06X03X07OL	6 1/8"	7 1/2"	3 1/8"



CHESTERFIELD

Product ID	W	H	D
COR06X04X09CH	6 1/8"	9 1/2"	4 5/8"



JACKSON

Product ID	W	H	D
COR06X04X14JA	6 1/8"	14 1/2"	4 1/4"



LEAF

Product ID	W	H	D
COR06X02X08LF	6 1/4"	8 1/4"	2 7/8"



HAMPSHIRE

Product ID	W	H	D
COR06X18X04HA	6 1/4"	18 1/8"	4 3/8"



QUENTIN

Product ID	W	H	D
COR06X05X09QU	6 3/8"	9"	5 5/8"



ROSE

Product ID	W	H	D
COR06X03X10RO	6 1/2"	10 1/8"	3 5/8"



LEANDROS

Product ID	W	H	D
COR06X03X09LN	6 1/2"	9"	3 3/8"



MEDWAY

Product ID	W	H	D
COR06X03X10ME	6 1/2"	10"	3 5/8"



HOLMDEL

Product ID	W	H	D
COR06X05X10HO	6 5/8"	10"	5 1/4"



OAKLEAF

Product ID	W	H	D
COR06X04X10OA	6 3/4"	10 3/4"	4 3/8"



GRAPE BUNCH

Product ID	W	H	D
COR06X13X03GR	6 3/4"	13 3/4"	3 1/2"



ARTIS

Product ID	W	H	D
COR06X03X11AR	6 7/8"	11"	3 1/2"



FLORAL

Product ID	W	H	D
COR07X03X09FL	7"	9"	3 1/2"



SPRINGTIME

Product ID	W	H	D
COR07X03X09SP	7"	9"	3 1/2"



FOREST

Product ID	W	H	D
COR07X04X08FO	7 1/8"	8 1/4"	4 1/8"



NICOLE

Product ID	W	H	D
COR07X04X09NI	7 1/8"	8 5/8"	3 3/4"

**URETHANE CORBELS
& BRACKETS ARE
PERFECT FOR
BOTH INTERIOR &
EXTERIOR USE**

CORBELS



TRADITIONAL

Product ID	W	H	D
COR07X07X05TR	7 1/8"	7 1/2"	5 1/8"



NADIA

Product ID	W	H	D
COR07X03X10NA	7 1/4"	10 1/8"	3"



POMPEII

Product ID	W	H	D
COR07X03X08PO	7 3/8"	8 3/4"	3 1/4"



WAKEFIELD

Product ID	W	H	D
COR07X05X11WA	7 3/8"	11"	5 3/8"



TRISTAN

Product ID	W	H	D
COR07X04X07TN	7 1/2"	7 1/4"	4"



LEAF

Product ID	W	H	D
COR07X04X11LF	7 3/4"	11"	3 7/8"



FLOWER

Product ID	W	H	D
COR07X04X12FW	7 3/4"	12 3/8"	4 1/2"



DEVON

Product ID	W	H	D
COR07X06X14DE	7 3/4"	14 1/4"	6 1/2"



NEXUS

Product ID	W	H	D
COR08X06X11NE	7 7/8"	11 3/4"	6 1/8"

**DID YOU KNOW WE
MAKE CORBELS IN
WOOD?**



BEADED

Product ID	W	H	D
COR07X05X13BE	7 7/8"	13 3/8"	5 1/8"



METZ

Product ID	W	H	D
COR07X04X12ME	7 7/8"	12 1/8"	4 1/2"



SCROLL LEAF

Product ID	W	H	D
COR07X08X18SC	7 7/8"	18 1/4"	8 3/4"



WINDSOR

Product ID	W	H	D
COR08X04X12WI	8"	12"	4"



ACANTHUS

Product ID	W	H	D
COR08X05X14AC	8"	14 7/8"	5"



ACANTHUS

Product ID	W	H	D
COR08X06X23AC	8"	22 7/8"	6"



CORBELS



ROSE

Product ID	W	H	D
COR08X05X11RO	8 1/2"	11 3/8"	5 1/4"



LEAF

Product ID	W	H	D
COR08X06X13LF	8 5/8"	13 7/8"	6"



FOREST

Product ID	W	H	D
COR08X04X11FO	8 3/4"	11"	4 5/8"



ALEXANDRIA ROPE

Product ID	W	H	D
COR09X17X05AL	9 1/2"	17 3/8"	5 1/2"



MARSEILLE

Product ID	W	H	D
COR09X20X06MA	9 1/2"	20 1/8"	6 5/8"



MIDDLESBOROUGH

Product ID	W	H	D
COR09X07X11MD	9 5/8"	11"	7 3/4"



LINUS

Product ID	W	H	D
COR09X03X15LI	9 3/4"	15 3/4"	3 7/8"



SCROLL LEAF

Product ID	W	H	D
COR10X11X25SC	10 3/8"	12 1/2"	11 5/8"



ANGEL

Product ID	W	H	D
COR11X05X13AN	11 1/8"	13 3/8"	5 1/2"



ACANTHUS WITH SHELL

Product ID	W	H	D
COR14X08X05AC	8 1/2"	14 1/2"	5"



LYON

Product ID	W	H	D
COR11X05X14LY	11 3/4"	14 1/8"	5 7/8"



STRASBOURG

Product ID	W	H	D
COR11X08X20SG	11 5/8"	20 1/4"	8 5/8"

SURROUNDS



MARSEILLE

Product ID	W	H	D
SUR27X06X08MA	6 1/2"	27 3/8"	8 1/8"



SCROLL LEAF

Product ID	W	H	D
SUR34X08X08SC	7 7/8"	34"	7 7/8"



FAIRFAX

Product ID	W	H	D
COR08X06X28FA	8 1/4"	28 1/8"	6 7/8"



FAIRFAX

Product ID	W	H	D
SUR39X09X09FA	8 5/8"	39 1/4"	9 1/2"



DEVON

Product ID	W	H	D
SUR20X09X05DE	8 5/8"	20 1/8"	5 3/8"



MONIQUE

Product ID	W	H	D
SUR42X09X08MO	9 1/4"	41 3/4"	8 1/4"



CLASSIC

Product ID	W	H	D
SUR09X29X06CL	9 7/8"	29 1/2"	6 3/4"



MONIQUE

Product ID	W	H	D
COR10X05X37MO	10 1/8"	37"	5 7/8"



ANGEL

Product ID	W	H	D
COR11X05X40AN-R	11 1/4"	40 1/2"	5 5/8"



ANGEL

Product ID	W	H	D
COR11X05X40AN-L	11 1/4"	40 1/2"	5 5/8"

ONLAYS & APPLIQUES



ONLAYS & APPLIQUES



ANDREA

Product ID	W	H	P
ONL02X02X01AD	1 1/2"	1 1/2"	3"



LEAF

Product ID	W	H	P
ONL01X03LE	1 5/8"	3 1/8"	3/8"



SWINDON

Product ID	W	H	P
ONL02X02SW	2 1/8"	2 1/4"	3/8"



KEPLER

Product ID	W	H	P
ONL02X02X01KP	2 1/2"	2 1/2"	1/4"



FEDERAL

Product ID	W	H	P
ONL02X03X01FE	2 1/2"	3 1/4"	3/8"



ANTHONY

Product ID	W	H	P
ONL02X02AT	2 3/4"	2 3/8"	3/8"



BLACKTHORNE

Product ID	W	H	P
ONL02X03X00BL	2 3/4"	3 3/4"	3/4"



GRAPE

Product ID	W	H	P
ONL02X04GR	2 3/4"	4 1/8"	3/8"



FLEUR-DE-LIS

Product ID	W	H	P
ONL04X03X01FL	2 3/4"	4"	1/2"



FEDERAL

Product ID	W	H	P
ONL02X05FE	2 3/4"	5 7/8"	3/8"

OVER
200
ONLAYS

ONLAYS & APPLIQUES



ELSINORE

Product ID	W	H	P
ONL03X02EL	3"	2 3/4"	3/8"



FOLIAGE

Product ID	W	H	P
ONL03X04X01LF	3"	4 1/2"	1/2"



SOUTHAMPTON

Product ID	W	H	P
ONL03X03SO	3 1/8"	3 1/8"	1/2"



BOW

Product ID	W	H	P
ONL03X02X01BW	3 1/8"	2 3/8"	3/8"



HAVEN

Product ID	W	H	P
ONL03X03X01HV	3 3/8"	3 3/8"	5/8"



ODESSA

Product ID	W	H	P
ONL03X03X01OD	3 3/8"	3 3/8"	1/2"



CLASSIC

Product ID	W	H	P
ONL07X03X01CL	3 1/2"	7 1/8"	5/8"



EMERY

Product ID	W	H	P
ONL04X04X01EM	3 3/4"	3 3/4"	1/2"



EDINBURGH

Product ID	W	H	P
ONL03X03ED	3 3/4"	3 3/4"	1/4"



MEDWAY

Product ID	W	H	P
ONL03X02X01ME	3 7/8"	2"	5/8"



FERARA

Product ID	W	H	P
ONL03X03FE	3 7/8"	3 7/8"	3/8"



URN

Product ID	W	H	P
ONL04X07X01UR	3 7/8"	6 3/4"	1"



FLEUR-DE-LIS

Product ID	W	H	P
ONL06X04X01FL	4"	6"	5/8"



HARVEST

Product ID	W	H	P
ONL06X04X01HA	4"	6 1/8"	3/4"

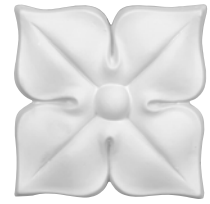

HELENE

Product ID	W	H	P
ONL04X04X01HE	4 1/8"	4 1/8"	5/8"



BORDEAUX

Product ID	W	H	P
ONL03X04X01BO	4 1/8"	3 1/4"	3/4"



TREVISO

Product ID	W	H	P
ONL04X04TR	4 1/4"	4 1/2"	1/2"

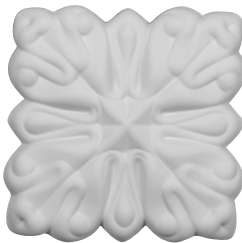

EMILY

Product ID	W	H	P
ONL04X04X01EY	4 1/4"	4 1/4"	1/2"



FLOWER BASKET

Product ID	W	H	P
ONL04X06X01FL	4 1/4"	6 1/4"	7/8"



FEDERAL

Product ID	W	H	P
ONL04X09FE	4 3/8"	9"	1 3/8"

ONLAYS & APPLIQUES



KAYA

Product ID	W	H	P
ONL04X04X01KA	4 3/8"	4 3/8"	3/4"



SPRINGTIME

Product ID	W	H	P
ONL04X02SP	4 1/2"	2 3/8"	3/8"



ROBIN

Product ID	W	H	P
ONL04X06RB	4 3/4"	6 1/4"	1"



OXFORD

Product ID	W	H	P
ONL04X06X01OX	4 3/4"	6 1/2"	1 1/8"



HARVEST

Product ID	W	H	P
ONL05X11X02HA	4 5/8"	10 5/8"	1 5/8"



HAVEN

Product ID	W	H	P
ONL05X05X01HV	4 7/8"	4 7/8"	3/4"



SHELL

Product ID	W	H	P
ONL04X04SH	4 7/8"	4 7/8"	5/8"



ALEXA

Product ID	W	H	P
ONL05X05AL	5"	5"	1"



TRADITIONAL

Product ID	W	H	P
ONL05X05TR	5"	5"	7/8"



FLORAL

Product ID	W	H	P
ONL05X03X01FL	5"	3"	1/2"



RIBBON

Product ID	W	H	P
ONL05X03X01RI	5"	3 1/2"	1/2"



GENOVA

Product ID	W	H	P
ONL05X03GE	5 1/8"	3 7/8"	3/8"



WASHINGTON

Product ID	W	H	P
ONL05X03X01WA	5 1/8"	2 1/2"	3/8"



ARTIS

Product ID	W	H	P
ONL05X05AR	5 1/8"	5 1/8"	3/4"



COLE

Product ID	W	H	P
ONL05X05CO	5 1/8"	5 1/8"	3/4"



URN

Product ID	W	H	P
ONL05X06X01UR	5 1/8"	6 7/8"	1 1/8"



KAYA

Product ID	W	H	P
ONL05X05X01KA	5 1/4"	5 1/4"	3/4"



BORDEAUX

Product ID	W	H	P
ONL05X02X01BO	5 1/2"	2 3/4"	3/4"



NEXUS

Product ID	W	H	P
ONL05X04X01NE	5 1/2"	4 5/8"	3/4"



HARVEST

Product ID	W	H	P
ONL08X06X01HA	5 1/2"	8 1/4"	1 1/8"



HILLSBOROUGH

Product ID	W	H	P
ONL05X06HI	5 1/2"	6 3/4"	1"



GRAPE AND LEAF

Product ID	W	H	P
ONL05X08X01GR	5 1/2"	8 5/8"	1"

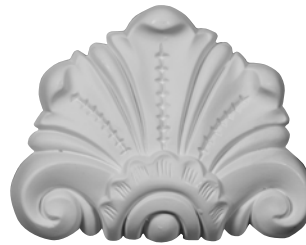

COSMO

Product ID	W	H	P
ONL04X06X01CO	5 3/4"	4 3/8"	1 1/8"



OXFORD

Product ID	W	H	P
ONL03X06X01OX	5 3/4"	3 1/8"	3/4"

ONLAYS & APPLIQUES

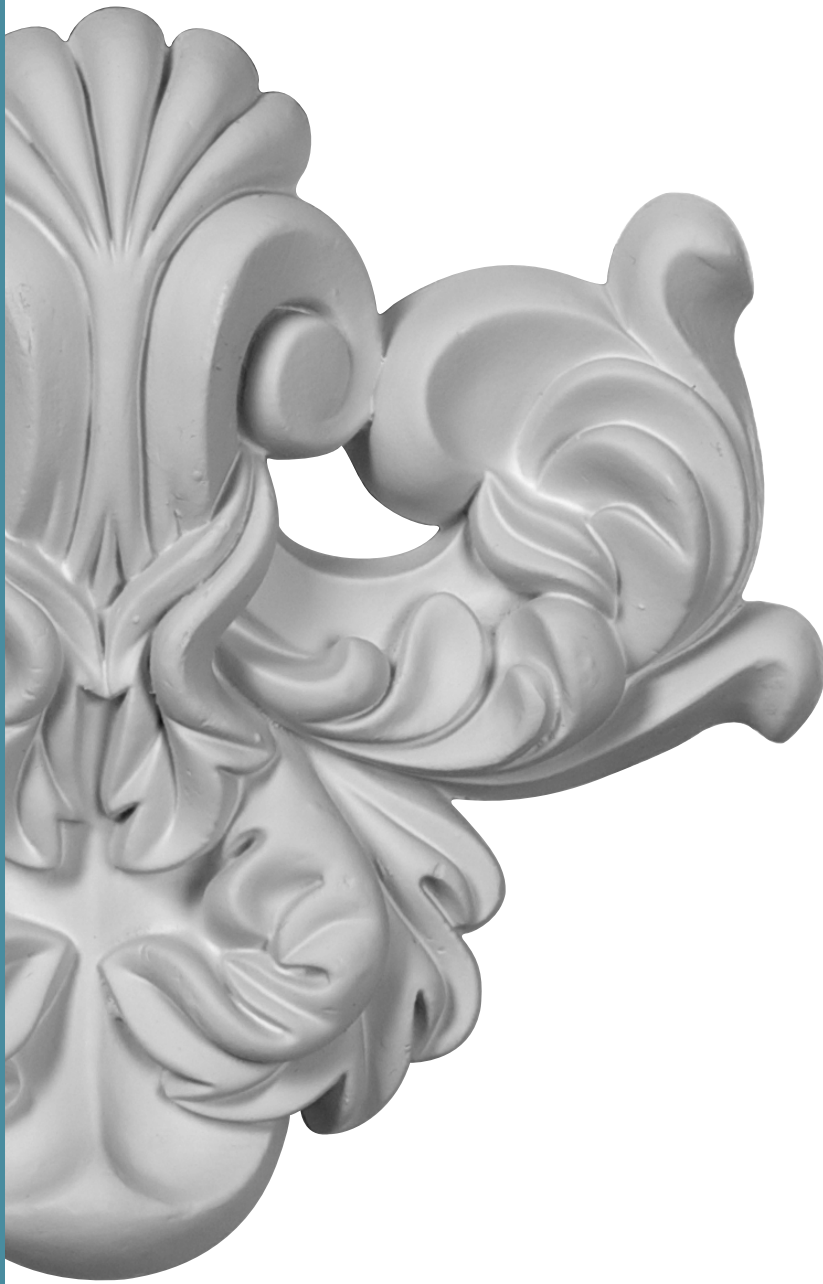

WINGS

Product ID	W	H	P
ONL05X01X01WI	5 5/8"	1 3/8"	1/2"



AVERY

Product ID	W	H	P
ONL22X06X01AV	22 1/4"	5 7/8"	1"



COLE

Product ID	W	H	P
ONL06X07X01CO	6 1/8"	6 7/8"	1"



LEAF BUNDLE

Product ID	W	H	P
ONL06X08X01LF	6 1/4"	8 3/4"	3/4"



STAR

Product ID	W	H	P
ONL06X06X01ST	6 1/2"	6 1/2"	5/8"



ANGEL

Product ID	W	H	P
ONL06X07X01AN	6 1/2"	7 1/8"	1 3/8"



LEAF

Product ID	W	H	P
ONL06X10X02LE	6 3/8"	10 3/8"	2"



GENOVA

Product ID	W	H	P
ONL06X02GE	6 3/4"	2 3/4"	1/4"



QUENTIN DIAMOND

Product ID	W	H	P
ONL06X03QU	6 3/4"	3 1/8"	5/8"



WREATH

Product ID	W	H	P
ONL07X02X01WR	7"	2 5/8"	5/8"



OSLO

Product ID	W	H	P
ONL07X03X01OS	7 1/8"	3 3/4"	5/8"



GRAPE BUNCH

Product ID	W	H	P
ONL07X09X01GR	7 1/8"	9 1/4"	1 1/8"



MADRID

Product ID	W	H	P
ONL07X10X02MA	7 1/4"	10"	1 5/8"

ONLAYS ARE A GREAT WAY TO MAKE YOUR HOME MORE BEAUTIFUL

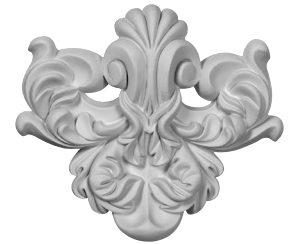

BENSON

Product ID	W	H	P
ONL07X06X01BE	7 3/8"	6 1/2"	1 3/8"



KENT

Product ID	W	H	P
ONL07X04X01KE	7 1/2"	3 7/8"	5/8"



ASHFORD

Product ID	W	H	P
ONL08X04X01AS	8 7/8"	4 3/4"	3/4"

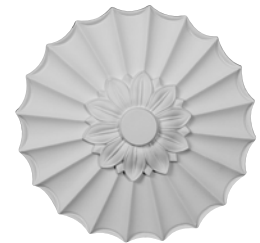

GALVESTON

Product ID	W	H	P
ONL09X09X02GL	8 7/8"	8 7/8"	1 1/2"

ONLAYS & APPLIQUES



DANIELA

Product ID	W	H	P
ONL09X02X01DN	9"	2 1/2"	3/4"



HURLEY

Product ID	W	H	P
ONL07X11HU	7 5/8"	11 7/8"	1/2"



ASHFORD

Product ID	W	H	P
ONL07X03X01AS	7 3/4"	3 1/8"	3/4"



PIEDMONT

Product ID	W	H	P
ONL07X07PI	7 7/8"	7 7/8"	1/2"



CARRILLO

Product ID	W	H	P
ONL05X08X01CI	8"	4 3/4"	3/4"



PESARO

Product ID	W	H	P
ONL08X12X01PE	8"	12 1/8"	1"



WINGS

Product ID	W	H	P
ONL08X01X01WI	8 1/8"	1 3/4"	5/8"



FLOWER

Product ID	W	H	P
ONL08X12X01FL	8 1/4"	12 1/2"	1 1/4"



LARGE GRAPE

Product ID	W	H	P
ONL08X20X01GR	8 1/4"	20 1/8"	1 5/8"



**ONLAYS QUALIFY FOR THE
LOCAL PRO PROGRAM**

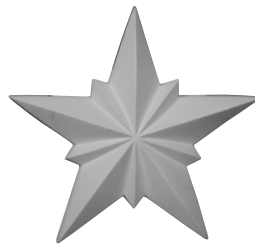

STAR

Product ID	W	H	P
ONL08X08X01ST	8 1/4"	8 1/4"	1"



SCROLL CENTER

Product ID	W	H	P
ONL08X03X01SC	8 5/8"	3 1/8"	7/8"



EDINBURGH

Product ID	W	H	P
ONL08X04X01ED	8 5/8"	3 7/8"	5/8"



OXFORD

Product ID	W	H	P
ONL05X09X01OX	8 5/8"	4 7/8"	7/8"



NEXUS

Product ID	W	H	P
ONL17X09X01NE	8 5/8"	16 1/2"	1 1/8"



DUBLIN

Product ID	W	H	P
ONL08X07DU	8 5/8"	7 7/8"	3/4"



WINGS

Product ID	W	H	P
ONL09X02X01WI	9"	2"	5/8"



RALSTON

Product ID	W	H	P
ONL18X09X02RA	9"	17 7/8"	1 3/4"



EMERY

Product ID	W	H	P
ONL09X03ER	9"	3 7/8"	3/4"



BORDEAUX

Product ID	W	H	P
ONL09X04X01BO	9"	4 3/4"	1 1/8"



MODERN SHELL

Product ID	W	H	P
ONL09X05X01SH	9"	5 3/8"	1 1/8"



LUNEL

Product ID	W	H	P
ONL09X12X01LU	9"	12 1/8"	1 1/4"

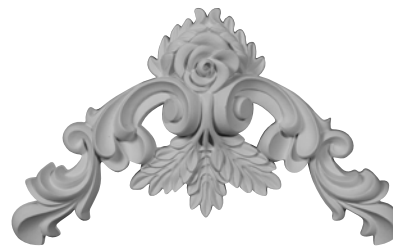

NORWICH

Product ID	W	H	P
ONL09X05X01NO	9"	5 1/2"	1 1/8"



VERSAILLES

Product ID	W	H	P
ONL09X03X01VE	9 1/4"	3"	3/4"

ONLAYS & APPLIQUES

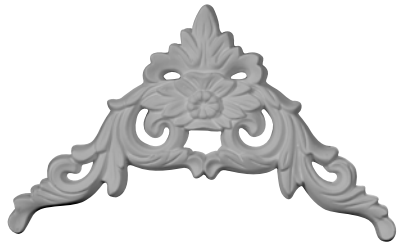

VERSAILLES

Product ID	W	H	P
ONL05X09X01VE	9 1/4"	5 1/2"	3/4"



MARCELLA

Product ID	W	H	P
ONL09X09MA	9 1/2"	9 1/2"	3/4"



AMELIA

Product ID	W	H	P
ONL10X07X01AM	9 1/2"	7 1/4"	1"



NICOLE

Product ID	W	H	P
ONL09X04NI	9 1/2"	4 5/8"	1/2"



FINLEY

Product ID	W	H	P
ONL09X02X01CL	9 3/8"	2 1/8"	7/8"



KENT

Product ID	W	H	P
ONL09X06KE	9 7/8"	6 1/4"	1/2"



STRASBOURG

Product ID	W	H	P
ONL04X10X01SG	9 7/8"	3 3/4"	7/8"



FLORAL

Product ID	W	H	P
ONL10X01X01FL	10 1/4"	1 5/8"	1/4"

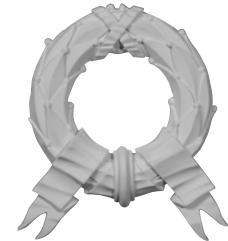

WREATH

Product ID	W	H	P
ONL10X11X01WR	10 1/4"	11 3/8"	1"



GENEVIEVE

Product ID	W	H	P
ONL10X07GN	10 1/2"	7 1/8"	1 3/8"



WINGS

Product ID	W	H	P
ONL10X02X01WI	10 5/8"	2 1/4"	3/4"



GLADSTONE

Product ID	W	H	P
ONL10X05X01GL	10 5/8"	5 1/4"	7/8"



MONIQUE

Product ID	W	H	P
ONL10X05X01MO	10 5/8"	5 3/4"	1 3/8"



FLOWER BASKET

Product ID	W	H	P
ONL10X13X01FB	10 5/8"	13 1/4"	1 3/4"



LARGE BUNCH

Product ID	W	H	P
ONL10X13X02GR	10 5/8"	13 3/8"	1 5/8"

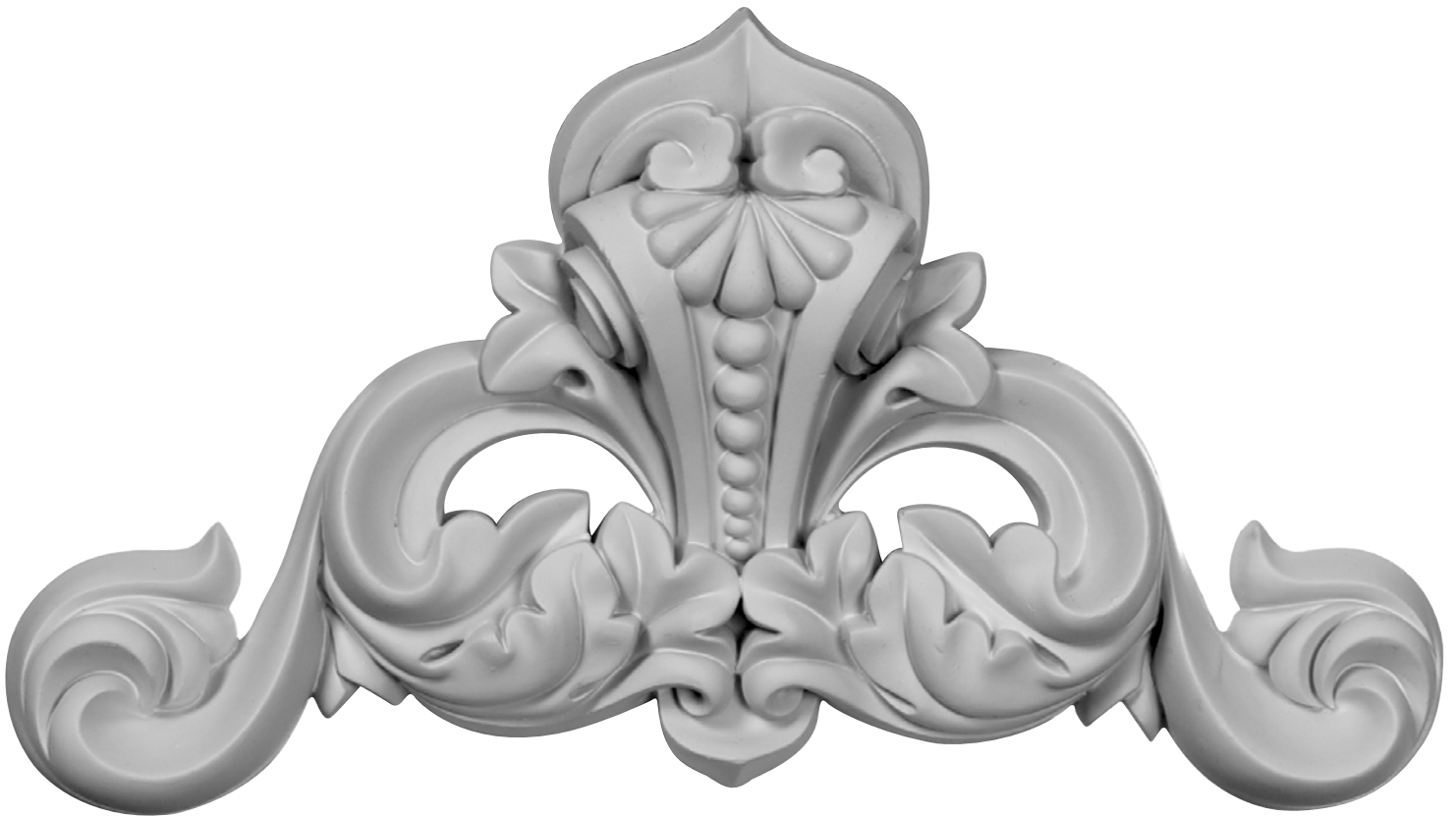

GENEVIEVE

Product ID	W	H	P
ONL11X11X01GN	10 5/8"	10 5/8"	3/4"



BENSON

Product ID	W	H	P
ONL10X04X01BN	10 5/8"	3 7/8"	5/8"



GENOVA

Product ID	W	H	P
ONL11X06X02GE	10 7/8"	6 1/8"	1 1/2"

ONLAYS & APPLIQUES



PALMETTO

Product ID	W	H	P
ONL12X02X01PA	12 1/4"	2 3/4"	5/8"

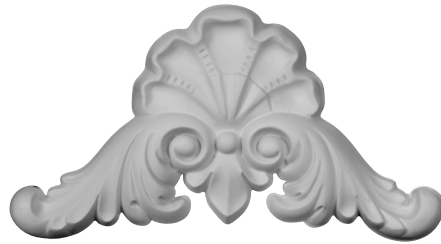

CARRILLO

Product ID	W	H	P
ONL06X12X01CI	12 1/4"	6 1/8"	1 1/8"



KEPLER

Product ID	W	H	P
ONL12X04KE	12 3/8"	4 3/8"	1/4"



GERALD

Product ID	W	H	P
ONL11X08GD	11"	3 1/8"	1/2"



WREATH

Product ID	W	H	P
ONL11X04WR	11 1/4"	4 3/4"	5/8"



LEAF SPAN

Product ID	W	H	P
ONL11X01X01LF	11 3/8"	1 7/8"	1/2"



SALEM

Product ID	W	H	P
ONL11X06X01SA	11 3/8"	6 1/2"	1 3/8"



MODENA

Product ID	W	H	P
ONL11X10X01MO	11 3/8"	10 5/8"	1"



SMALL SCROLL

Product ID	W	H	P
APL11X02X01SC	11 1/2"	2 7/8"	3/4"



MINI SHELL

Product ID	W	H	P
APL11X06X01SH	11 1/2"	6"	1 3/8"

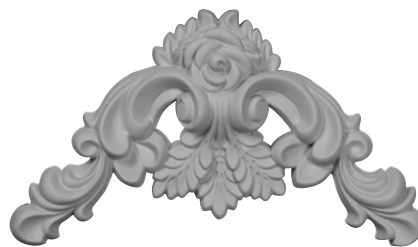

NORWICH

Product ID	W	H	P
ONL11X06X01NO	11 1/2"	6 3/8"	1 3/8"



SALERNO

Product ID	W	H	P
ONL11X11SA	11 3/4"	11 3/4"	1"



COLE

Product ID	W	H	P
ONL11X2X01CO	11 3/4"	2 3/4"	5/8"



PEARL

Product ID	W	H	P
ONL11X03X01PE	11 3/4"	3 1/2"	7/8"



COLE

Product ID	W	H	P
ONL12X03X01CO	11 3/4"	3 1/8"	1/2"



ORLEANS

Product ID	W	H	P
ONL11X03X01OL	11 3/4"	3 3/4"	1 1/4"



BAILE

Product ID	W	H	P
ONL11X02X0BI	11 5/8"	1 3/4"	3/4"

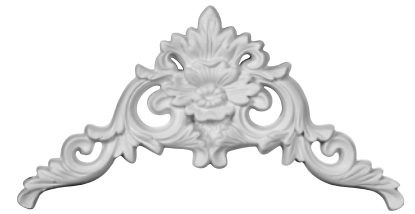

VERSAILLES

Product ID	W	H	P
ONL06X12X01VE	11 7/8"	6 1/4"	7/8"



MARCELLA

Product ID	W	H	P
ONL12X04X01MA	12"	3 3/4"	5/8"



ODESSA

Product ID	W	H	P
ONL12X12X00OD	12"	12"	7/8"

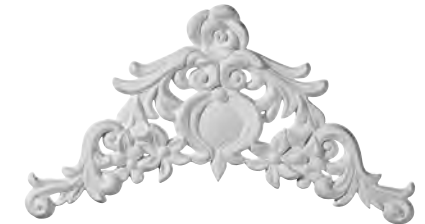

COLE

Product ID	W	H	P
ONL12X06X01CO	12 1/8"	6 3/4"	5/8"



BENSON

Product ID	W	H	P
ONL12X10X01BE	12 1/2"	10 5/8"	1 1/2"



VINYARD TWIST

Product ID	W	H	P
ONL12X03X01VN	12 3/4"	3 1/2"	5/8"

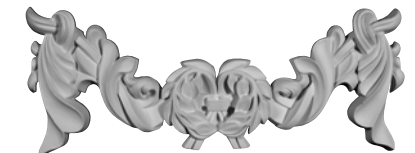

AMELIA

Product ID	W	H	P
ONL13X05X01AM	13"	5 1/8"	1 1/8"

ONLAYS & APPLIQUES



VERSAILLIES

Product ID	W	H	P
ONL13X03X01VE	13"	3"	3/4"



MONIQUE

Product ID	W	H	P
ONL13X20X01MO	13 1/2"	20"	1 1/4"



PALMETTO

Product ID	W	H	P
ONL13X05X01PM	13 5/8"	5 1/8"	1"



HERA

Product ID	W	H	P
ONL14X21X08HE	13 3/4"	20 7/8"	7 7/8"



KENT

Product ID	W	H	P
ONL13X03X01KE	13 3/4"	3"	3/4"



FLOWER

Product ID	W	H	P
ONL05X14X01FL	13 3/4"	4 3/4"	1 1/4"



NADIA

Product ID	W	H	P
ONL13X05X01NA	13 3/4"	5 1/2"	1"



EDWARDS

Product ID	W	H	P
ONL13X05X01ED	13 3/4"	6 1/8"	1"



SHELL

Product ID	W	H	P
ONL14X04X01SH	14 3/8"	4 1/2"	1"



EMERY

Product ID	W	H	P
ONL08X04X00EM	15"	15"	3/4"



ATHENA

Product ID	W	H	P
ONL15X20X10AT	15"	20 1/8"	10 1/4"



SEA SHELL

Product ID	W	H	P
ONL15X09X01SE	15"	9 1/4"	1 1/8"

**ONLAYS CAN
BE USED AS AN
INEXPENSIVE
WAY TO DRESS
UP ANY PROJECT!**



HAMILTON

Product ID	W	H	P
ONL15X09X01HA	15 1/4"	9 1/4"	1 1/8"

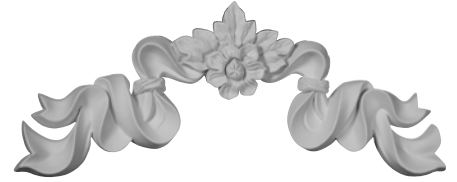

VERSAILLES

Product ID	W	H	P
ONL15X06X01VE	15 1/4"	6 1/4"	1"

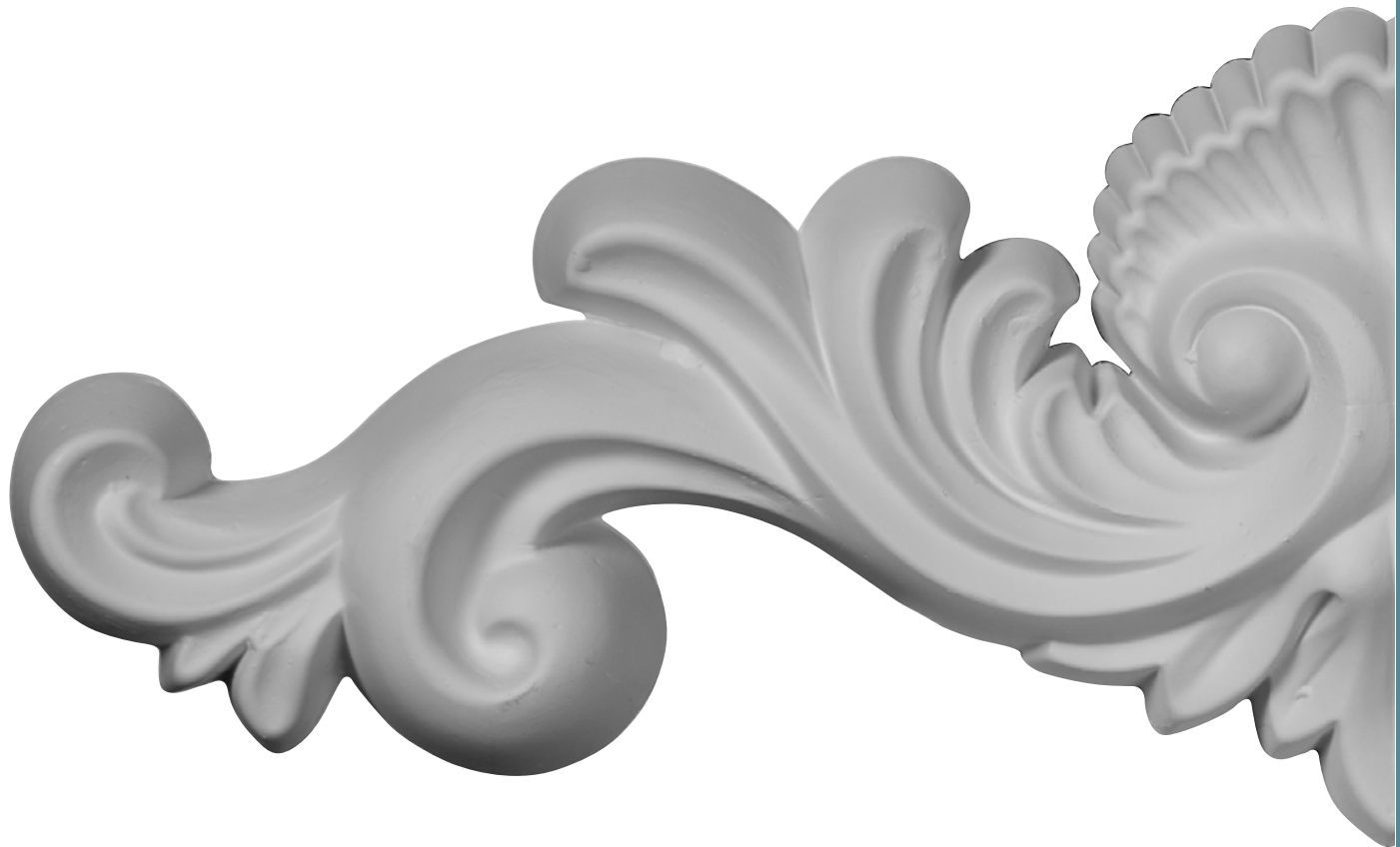

ODESSA

Product ID	W	H	P
ONL23X00OD	15 3/4"	14 3/4"	5/8"



FLORAL

Product ID	W	H	P
ONL15X04X01FL	15 5/8"	4"	3/4"



SHELL

Product ID	W	H	P
ONL16X08X01SH	16"	8 7/8"	1 1/2"

ONLAYS & APPLIQUES



FORLI

Product ID	W	H	P
ONL16X04X01FO	16"	4 3/8"	1 1/2"



ASHFORD

Product ID	W	H	P
ONL16X07AS	16"	7 1/8"	5/8"



HESTIA

Product ID	W	H	P
ONL16X17X08HE	16 1/8"	16 7/8"	8 1/2"



SMALL SHELL

Product ID	W	H	P
APL16X08X01SH	16 1/4"	8 3/4"	1 5/8"



BEDFORD

Product ID	W	H	P
ONL16X08X02BE	16 3/8"	8 3/4"	2"



MARCELLA

Product ID	W	H	P
ONL16X04X01MA	16 3/8"	4 3/4"	3/4"



RALSTON

Product ID	W	H	P
ONL09X16X02RA	16 3/8"	8 7/8"	2"



ZEUS

Product ID	W	H	P
ONL17X17X08ZE	16 3/4"	17 3/8"	8 1/4"



ASHFORD

Product ID	W	H	P
ONL16X05AS	16 7/8"	5 7/8"	1/2"



ELLIPTICAL

Product ID	W	H	P
ONL17X04ES	17"	4 3/8"	3/8"



VERSAILLES

Product ID	W	H	P
ONL17X03X01VE	17 1/8"	3"	7/8"



TEMPLE

Product ID	W	H	P
ONL18X18X02TE	18 1/8"	18 1/8"	2 1/4"



SHELL

Product ID	W	H	P
ONL18X12X01SH	18 1/4"	12 3/8"	1 3/4"



SWINDON

Product ID	W	H	P
ONL18X09X01SW	18 1/2"	9 7/8"	3/4"



KINSLEY

Product ID	W	H	P
ONL08X19X02KI	18 3/4"	8 1/2"	1 3/4"



BANNER

Product ID	W	H	P
ONL19X10X01BA	18 7/8"	9 1/2"	5/8"



EMERY

Product ID	W	H	P
ONL19X11X01EM	19 1/4"	11 1/2"	1 5/8"



SMALL GRAPE

Product ID	W	H	P
ONL19X05X01GR	19 1/4"	5 3/8"	7/8"

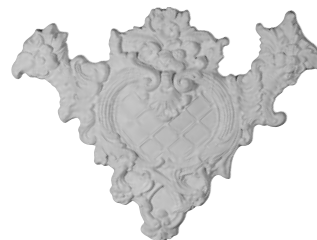

BENSON

Product ID	W	H	P
ONL20X20BN	20 1/2"	20 1/2"	1 1/2"



BIDDOX DROP

Product ID	W	H	P
ONL14X20BX	20 7/8"	14 1/8"	1 5/8"

ONLAYS & APPLIQUES

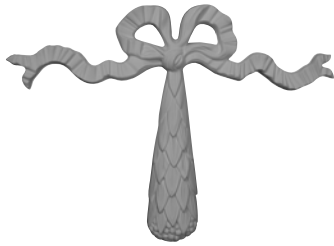

DUBLIN

Product ID	W	H	P
ONL21X15X01DU	21 1/8"	15 3/8"	1 1/8"



GRAPE

Product ID	W	H	P
ONL21X04X01GR	21 3/8"	4 5/8"	1 3/8"



MODENA

Product ID	W	H	P
ONL22X20MO	21 5/8"	19 3/4"	2 3/8"



SAVONA

Product ID	W	H	P
ONL22X08SA	22 1/4"	8 7/8"	1 1/8"



EDWARDS

Product ID	W	H	P
ONL22X18ED	22 1/4"	18 3/8"	2 1/4"



MARCELLA

Product ID	W	H	P
ONL22X06X01MA	22 1/2"	6 3/4"	1 1/8"



MEDIUM SCROLL

Product ID	W	H	P
APL23X05X01SC	23 1/8"	5 7/8"	1 1/8"



SCROLL

Product ID	W	H	P
ONL23X07X01SC	23 1/2"	7 1/4"	1 7/8"



JACKSON

Product ID	W	H	P
ONL24X09X01JA	24 3/8"	9 3/8"	1 3/4"



DUBLIN

Product ID	W	H	P
ONL25X05X01DU	25"	5 1/2"	1 3/8"



TURIN

Product ID	W	H	P
ONL26X16X01TU	26"	16 1/2"	1"



MELCHOR

Product ID	W	H	P
ONL26X26ME	26 3/8"	26 3/8"	7/8"



ANGEL

Product ID	W	H	P
APL28X09X02SC	28 1/2"	9 5/8"	2 3/4"



KINSLEY

Product ID	W	H	P
ONL21X26KI	21 1/4"	25 5/8"	1 1/4"



LARGE SHELL

Product ID	W	H	P
APL28X15X02SH	28 3/4"	15 1/8"	2 7/8"

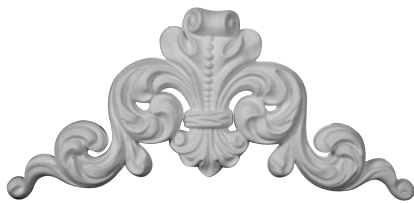

RALSTON

Product ID	W	H	P
ONL14X30X02RA	29 1/2"	13 3/4"	2 1/8"



QUEENSTOWN

Product ID	W	H	P
ONL31X14X02QU	31"	14 1/4"	2 3/8"



LEGACY

Product ID	W	H	P
ONL32X09X01LE	32 1/4"	8 7/8"	1 5/8"



EMILY

Product ID	W	H	P
ONL10X34X02EY	34 1/4"	10 1/4"	2"



PESCARA

Product ID	W	H	P
ONL34X05X01PE	34 1/4"	5 1/4"	1 3/4"

CHECK OUT OUR
**WOOD
ONLAYS**



ONLAYS & APPLIQUES



SHELL

Product ID	W	H	P
ONL34X05X01SH	34 1/2"	5 1/2"	1 3/4"



FLOWER BASKET

Product ID	W	H	P
ONL35X12X02FB	35 1/8"	12 1/2"	2 1/8"



HARVEST

Product ID	W	H	P
ONL08X36X02HA	35 3/4"	7 7/8"	1 5/8"



HAVEN

Product ID	W	H	P
ONL11X37X02HV	36 3/4"	11 3/8"	1 5/8"



LARGE SCROLL

Product ID	W	H	P
APL36X09X01SC	36 3/4"	9 3/4"	1 3/8"



VALENCE

Product ID	W	H	P
ONL36X13VA	36 3/4"	13 3/4"	1 3/4"



LARGE GRAPE

Product ID	W	H	P
ONL39X08X02GR	39"	8 7/8"	1 3/8"



FLOWER BASKET

Product ID	W	H	P
ONL40X12FB	40 1/2"	12 1/4"	2 3/4"



ANGEL SCROLL

Product ID	W	H	P
APL42X21X03AN	42 1/4"	21 1/4"	3 1/8"



KENDALL

Product ID	W	H	P
ONL42X08KD	42 3/8"	8 3/8"	2 1/2"



QUENTIN

Product ID	W	H	P
ONL43X04X01QU	43 1/4"	7"	1 1/4"



MEDWAY

Product ID	W	H	P
ONL46X09X01ME	46"	9"	1 1/8"



VICEROY

Product ID	W	H	P
ONL48X06X02VI	48"	6"	2 1/4"



MARSEILLE

Product ID	W	H	P
ONL08X53X02MA	53 1/8"	8"	1 5/8"

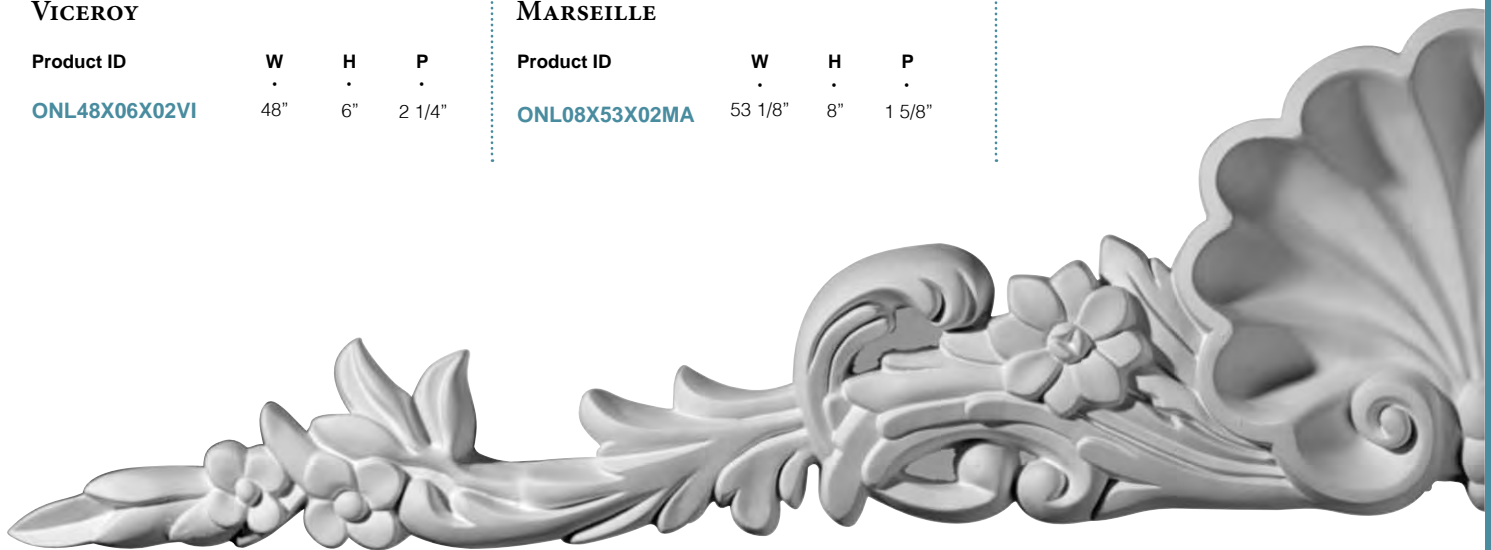

LEFT & RIGHT ONLAYS



LEFT HILLSBOROUGH

RIGHT HILLSBOROUGH

Product ID	W	P	H	Product ID	W	P	H
ONL02X06X01HI-L	2 1/2"	5/8"	6 1/4"	ONL02X06X01HI-R	2 1/2"	5/8"	6 1/4"



LEFT GRANADA

RIGHT GRANADA

Product ID	W	P	H	Product ID	W	P	H
ONL02X07X01GR-L	2 1/8"	5/8"	7 3/8"	ONL02X07X01GR-R	2 1/8"	5/8"	7 3/8"



LEFT WAKEFIELD

RIGHT WAKEFIELD

Product ID	W	P	H	Product ID	W	P	H
ONL03X01WA-L	3 1/4"	3/8"	1 5/8"	ONL03X01WA-R	3 1/4"	3/8"	1 5/8"

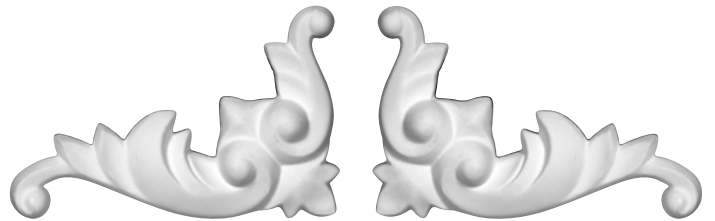

LEFT ATTICA

RIGHT ATTICA

Product ID	W	P	H	Product ID	W	P	H
ONL03X05X01AT-L	3"	3/4"	4 7/8"	ONL03X05X01AT-R	3"	3/4"	4 7/8"



LEFT LEGACY

RIGHT LEGACY

Product ID	W	P	H	Product ID	W	P	H
ONL03X05X01LE-L	3 3/8"	1/2"	5"	ONL03X05X01LE-R	3 3/8"	1/2"	5"



LEFT WINGS

RIGHT WINGS

Product ID	W	P	H	Product ID	W	P	H
ONL03X05X01WI-L	2"	3/4"	7 1/2"	ONL03X05X01WI-R	2"	3/4"	7 1/2"

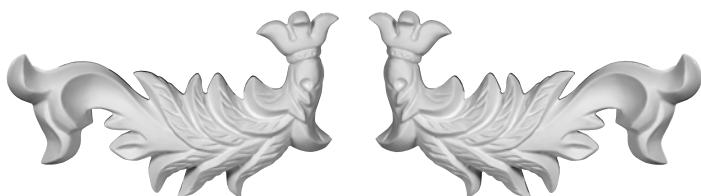

LEFT NEEDHAM

RIGHT NEEDHAM

Product ID	W	P	H	Product ID	W	P	H
ONL03X06X01NE-L	3 7/8"	3/4"	6 3/4"	ONL03X06X01NE-R	3 7/8"	3/4"	6 3/4"



LEFT RIBBON

RIGHT RIBBON

Product ID	W	P	H	Product ID	W	P	H
ONL03X07X01FL-L	7 3/4"	7/8"	3"	ONL03X07X01FL-R	7 3/4"	7/8"	3"

LEFT & RIGHT ONLAYS



LEFT MEDWAY

Product ID	W	P	H
ONL04X03ME-L	4 3/4"	1 1/2"	3"



RIGHT MEDWAY

Product ID	W	P	H
ONL04X03ME-R	4 3/4"	1 1/2"	3"



LEFT AVERY

Product ID	W	H	D
ONL08X15X01AV-L	15 3/8"	8 3/8"	1"

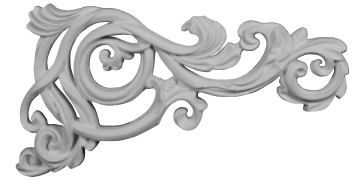

RIGHT AVERY

Product ID	W	H	D
ONL08X15X01AV-R	15 3/8"	8 3/8"	1"



LEFT OSLO

Product ID	W	P	H
ONL04X03OS-L	4 1/2"	1 1/4"	3 7/8"



RIGHT OSLO

Product ID	W	P	H
ONL04X03OS-R	4 1/2"	1 1/4"	3 7/8"



LEFT SEVILLE

Product ID	W	P	H
ONL04X06X01SE-L	6 1/8"	5/8"	4 1/8"



RIGHT SEVILLE

Product ID	W	P	H
ONL04X06X01SE-R	6 1/8"	5/8"	4 1/8"



LEFT LEAF

Product ID	W	P	H
ONL04X07X01LF-L	7 3/4"	3/4"	4 1/8"



RIGHT LEAF

Product ID	W	P	H
ONL04X07X01LF-R	7 3/4"	3/4"	4 1/8"

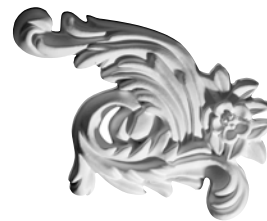

LEFT ZEPHYR

Product ID	W	P	H
ONL04X07X01ZE-L	4 1/4"	7/8"	7"

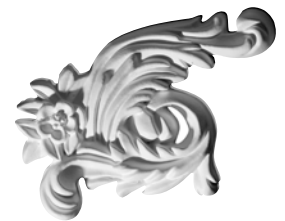

RIGHT ZEPHYR

Product ID	W	P	H
ONL04X07X01ZE-R	4 1/4"	7/8"	7"



LEFT MARIA

Product ID	W	P	H
ONL05X02X00MA-L	5 1/4"	7/8"	2 1/2"



RIGHT MARIA

Product ID	W	P	H
ONL05X02X00MA-R	5 1/4"	7/8"	2 1/2"



LEFT WELLINGTON

Product ID	W	P	H
ONL05X03WE-L	5 5/8"	1 1/2"	3"



RIGHT WELLINGTON

Product ID	W	P	H
ONL05X03WE-R	5 5/8"	1 1/2"	3"

LEFT & RIGHT ONLAYS



LEFT OAK

Product ID W P H
 ONL05X03X01OL-L 5 1/2" 5/8" 3 1/2"



RIGHT OAK

Product ID W P H
 ONL05X03X01OL-R 5 1/2" 5/8" 3 1/2"



LEFT ANGEL

Product ID W P H
 ONL05X06X01AN-L 5 1/8" 1 1/8" 6 5/8"



RIGHT ANGEL

Product ID W P H
 ONL05X06X01AN-R 5 1/8" 1 1/8" 6 5/8"

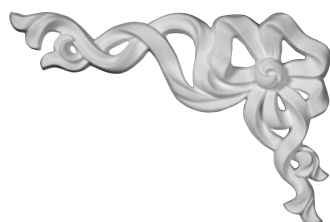

LEFT VERSAILLES

Product ID W P H
 ONL05X08X01-L 5 7/8" 3/4" 8 5/8"

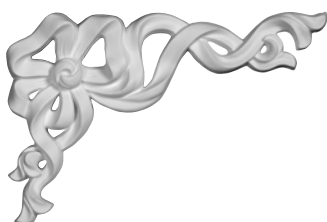

RIGHT VERSAILLES

Product ID W P H
 ONL05X08X01-R 5 7/8" 3/4" 8 5/8"



LEFT DAMON

Product ID W P H
 ONL05X09X01DA-L 9 3/4" 5/8" 5 1/4"

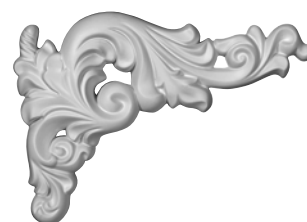

RIGHT DAMON

Product ID W P H
 ONL05X09X01DA-R 9 3/4" 5/8" 5 1/4"

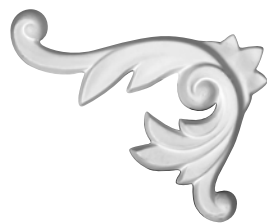

LEFT OXFORD

Product ID W P H
 ONL063X04X01OX-L 3 1/8" 5/8" 4 3/4"

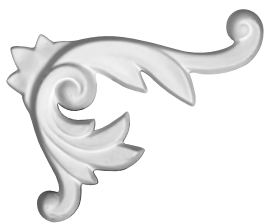

RIGHT OXFORD

Product ID W P H
 ONL063X04X01OX-R 3 1/8" 5/8" 4 3/4"



LEFT SELLEK

Product ID W P H
 ONL06X02SK-L 6 3/4" 1/2" 2"



RIGHT SELLEK

Product ID W P H
 ONL06X02SK-R 6 3/4" 1/2" 2"



LEFT ODESSA

Product ID W P H
 ONL07X02OD-L 2 3/4" 1/2" 7 3/4"



RIGHT ODESSA

Product ID W P H
 ONL07X02OD-R 2 3/4" 1/2" 7 3/4"



LEFT PIEDMONT

Product ID W P H
 ONL07X03PE-L 7 1/2" 1/2" 3 7/8"



RIGHT PIEDMONT

Product ID W P H
 ONL07X03PE-R 7 1/2" 1/2" 3 7/8"

LEFT & RIGHT ONLAYS



LEFT MEDWAY

Product ID W P H
 ONL07X04ME-L 7 7/8" 3/4" 4 1/8"



RIGHT MEDWAY

Product ID W P H
 ONL07X04ME-R 7 7/8" 3/4" 4 1/8"



LEFT COLTON

Product ID W P H
 ONL07X07X01CO-L 7 7/8" 3/4" 7 7/8"



RIGHT COLTON

Product ID W P H
 ONL07X07X01CO-R 7 7/8" 3/4" 7 7/8"



LEFT CHATEAU

Product ID W P H
 ONL08X03X01CH-L 8" 1/2" 3 1/8"

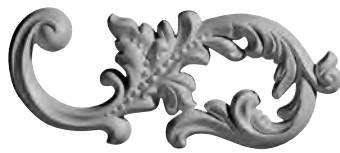

RIGHT CHATEAU

Product ID W P H
 ONL08X03X01CH-R 8" 1/2" 3 1/8"



LEFT SMALL GRAPE

Product ID W P H
 ONL08X04X01GR-L 8 5/8" 3/4" 4 3/8"



RIGHT SMALL GRAPE

Product ID W P H
 ONL08X04X01GR-R 8 5/8" 3/4" 4 3/8"



LEFT TERRONES

Product ID W P H
 ONL08X07TS-L 8 7/8" 3/4" 7 1/8"



RIGHT TERRONES

Product ID W P H
 ONL08X07TS-R 8 7/8" 3/4" 7 1/8"



LEFT ANGEL

Product ID W P H
 ONL08X08X01AN-L 8 1/4" 7/8" 8 5/8"



RIGHT ANGEL

Product ID W P H
 ONL08X08X01AN-R 8 1/4" 7/8" 8 5/8"

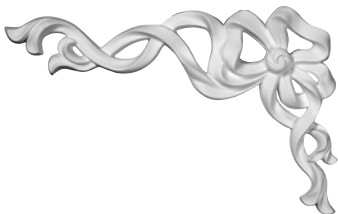

LEFT VERSAILLES

Product ID W P H
 ONL08X13X01VE-L 8 1/4" 7/8" 13"

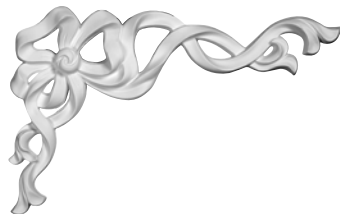

RIGHT VERSAILLES

Product ID W P H
 ONL08X13X01VE-R 8 1/4" 7/8" 13"



LEFT POMPEII

Product ID W P H
 ONL10X09X01PO-L 10 5/8" 1 1/8" 9 3/8"



RIGHT POMPEII

Product ID W P H
 ONL10X09X01PO-R 10 5/8" 1 1/8" 9 3/8"

LEFT & RIGHT ONLAYS



LEFT SEVILLE



RIGHT SEVILLE

Product ID W P H
 ONL10X09X01SE-L 10 5/8" 1 1/8" 9 3/8"

Product ID W P H
 ONL10X09X01SE-R 10 5/8" 1 1/8" 9 3/8"



LEFT MONIQUE



RIGHT MONIQUE

Product ID W P H
 ONL11X05X01MO-L 11" 1" 5 1/2"

Product ID W P H
 ONL11X05X01MO-R 11" 1" 5 1/2"

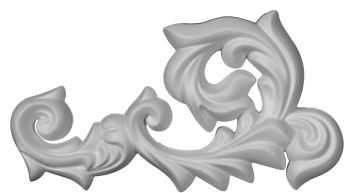

LEFT DIJON

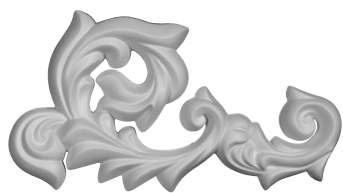

RIGHT DIJON

Product ID W P H
 ONL11X06X01DI-L 11 3/4" 1" 6 3/8"

Product ID W P H
 ONL11X06X01DI-R 11 3/4" 1" 6 3/8"

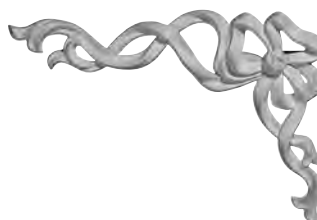

LEFT VERSAILLES

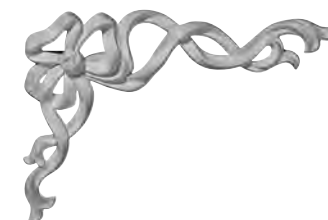

RIGHT VERSAILLES

Product ID W P H
 ONL11X15X01VE-L 11" 1 1/8" 15 3/4"

Product ID W P H
 ONL11X15X01VE-R 11" 1 1/8" 15 3/4"

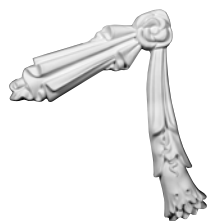

LEFT EMILY



RIGHT EMILY

Product ID W P H
 ONL10X13X01EY-L 12 3/4" 1 1/4" 9 7/8"

Product ID W P H
 ONL10X13X01EY-R 12 3/4" 1 1/4" 9 7/8"



LEFT LARGE GRAPE



RIGHT LARGE GRAPE

Product ID W P H
 ONL12X06X01GR-L 12 5/8" 1" 6 3/4"

Product ID W P H
 ONL12X06X01GR-R 12 5/8" 1" 6 3/4"

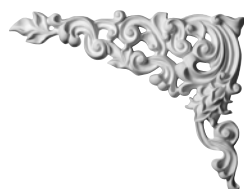

LEFT KINSLEY

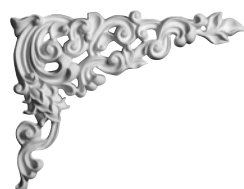

RIGHT KINSLEY

Product ID W P H
 ONL12X16KI-L 11 3/4" 1 3/8" 15 3/4"

Product ID W P H
 ONL12X16KI-R 11 3/4" 1 3/8" 15 3/4"



LEFT AVERY

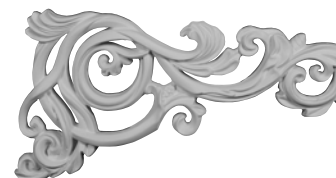

RIGHT AVERY

Product ID W P H
 ONL08X15X01AV-L 15 3/8" 1" 8 3/8"

Product ID W P H
 ONL08X15X01AV-R 15 3/8" 1" 8 3/8"

LEFT & RIGHT ONLAYS



LEFT ROBIN

Product ID	W	P	H
ONL15X05RB-L	15 3/4"	1 1/8"	5 1/8"



RIGHT ROBIN

Product ID	W	P	H
ONL15X05RB-R	15 3/4"	1 1/8"	5 1/8"



LEFT LOERA

Product ID	W	P	H
ONL15X07LO-L	15 3/4"	1"	7 1/8"



RIGHT LOERA

Product ID	W	P	H
ONL15X07LO-R	15 3/4"	1"	7 1/8"



LEFT EDWARDS

Product ID	W	P	H
ONL16X20ED-L	15 3/4"	1 3/8"	19 5/8"



RIGHT EDWARDS

Product ID	W	P	H
ONL16X20ED-R	15 3/4"	1 3/8"	19 5/8"



LEFT EDINBURGH

Product ID	W	P	H
ONL17X07X01ED-L	17 1/2"	1 1/8"	7"



RIGHT EDINBURGH

Product ID	W	P	H
ONL17X07X01ED-R	17 1/2"	1 1/8"	7"

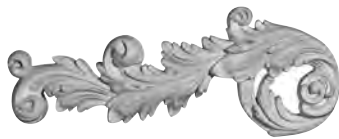

LEFT PARIS

Product ID	W	P	H
ONL17X07X01PA-L	17 3/4"	1 1/8"	7 3/8"



RIGHT PARIS

Product ID	W	P	H
ONL17X07X01PA-R	17 3/4"	1 1/8"	7 3/8"



LEFT LANARKSHIRE

Product ID	W	P	H
ONL23X04X00LA-L	23 3/8"	3/4"	4 1/2"



RIGHT LANARKSHIRE

Product ID	W	P	H
ONL23X04X00LA-R	23 3/8"	3/4"	4 1/2"



LEFT ELSINOR

Product ID	W	P	H
ONL26X06X01EL-L	26 3/4"	1 1/8"	6 5/8"



RIGHT ELSINOR

Product ID	W	P	H
ONL26X06X01EL-R	26 3/4"	1 1/8"	6 5/8"



LEFT SUSSEX

Product ID	W	P	H
ONL26X10X01SU-L	26 3/4"	1 5/8"	10 3/4"



RIGHT SUSSEX

Product ID	W	P	H
ONL26X10X01SU-R	26 3/4"	1 5/8"	10 3/4"

DROPS & SWAGS



HELENE DROP



Product ID
ONL01X02HE
W • 1 1/8"
H • 2 3/4"
P • 3/8"

MILTON DROP



Product ID
ONL01X04MI
W • 1 1/8"
H • 4 3/4"
P • 1/4"

VERSAILLES DROP



Product ID
ONL01X04VE
W • 1 3/4"
H • 4 3/8"
P • 3/8"

LAREGE FLOWER DROP



Product ID
ONL10X12X02FL
W • 10 1/4"
H • 24"
P • 1 5/8"

LAREGE FLOWER DROP

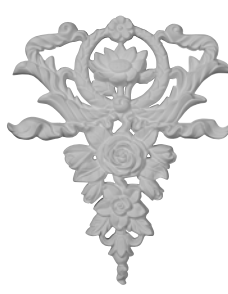

Product ID
ONL10X12X01FL
W • 10 5/8"
H • 12 5/8"
P • 3/4"

SHELL SCEPTER DROP



Product ID
ONL15X02X01SH
W • 2 1/4"
H • 15 5/8"
P • 3/4"

BENSON DROP



Product ID
ONL02X11BN

W • 2 3/4"

H • 11 3/4"

P • 3/8"

FEDERAL DROP



Product ID
ONL02X11FE

W • 2 3/4"

H • 11 3/4"

P • 5/8"

ALEXA DROP



Product ID
ONL02X15AX

W • 2 3/4"

H • 15"

P • 5/8"

DOGWOOD DROP



Product ID
ONL02X19DG

W • 2"

H • 19 5/8"

P • 3/4"

RIBBON DROP



Product ID
ONL25X27RI

W • 24 3/4"

H • 27 3/8"

P • 1"

VERSAILLES DROP



Product ID
ONL03X09X01VE

W • 3 1/2"

H • 9 1/2"

P • 5/8"

SMALL ROSE DROP



Product ID
ONL03X08X01RO

W • 3 1/8"

H • 8 1/4"

P • 1"

ASHFORD DROP



Product ID
ONL03X12AS

W • 3 3/8"

H • 12 3/4"

P • 5/8"

HILLSBOROUGH DROP



Product ID
ONL03X19X01HI

W • 3 7/8"

H • 19 1/4"

P • 1 1/4"

BARCELONA DROP



Product ID
ONL03X11X01BA

W • 3"

H • 11 3/4"

P • 1 3/4"

SMALL FLOWERS DROP



Product ID
ONL04X10X01FL

W • 4 1/2"

H • 10"

P • 5/8"

VERSAILLES DROP



Product ID
ONL04X11X01VE

W • 4 3/4"

H • 11 3/8"

P • 7/8"

DROPS & SWAGS

WREATH DROP



Product ID
ONL04X19X01WR
W • 4 5/8"
H • 19 1/2"
P • 1 3/8"

DAUPHINE DROP



Product ID
ONL04X09X01DA
W • 4 7/8"
H • 9 1/2"
P • 1"

ROSE DROP



Product ID
ONL05X15X02RO
W • 5 1/8"
H • 15 3/4"
P • 4 5/8"

MILTON DROP



Product ID
ONL05X13X01MI
W • 5 1/8"
H • 13"
P • 1"

VERSAILLES DROP



Product ID
ONL05X16X01VE
W • 5 3/4"
H • 16 1/8"
P • 1"

FLOWER DROP DROP



Product ID
ONL05X06X01FL
W • 5 3/4"
H • 6 1/2"
P • 5/8"

FRUIT DROP



Product ID
ONL05X10FR
W • 5 3/8"
H • 9 3/4"
P • 1 3/8"

MONIQUE DROP



Product ID
ONL05X05X01MO
W • 5 7/8"
H • 5 1/8"
P • 5/8"

OSLO DROP



Product ID
ONL05X33OS-L
W • 5 7/8"
H • 33 1/8"
P • 3/8"

OSLO DROP



Product ID
ONL05X33OS-R
W • 5 7/8"
H • 33 1/8"
P • 3/8"

ROSE & RIBBON DROP



Product ID
ONL06X09RO
W • 6 1/2"
H • 9"
P • 1"

MENTON DROP



Product ID
ONL06X12ME
W • 6 3/4"
H • 12 3/8"
P • 1 1/4"

LENS DROP



Product ID
ONL06X13LE
W • 6 3/4"
H • 13 1/2"
P • 1 5/8"

CHESTERFIELD DROP



Product ID
ONL06X05X01CH
W • 6 7/8"
H • 5 1/8"
P • 5/8"

FLOWER BELL V



Product ID
ONL06X37FL-L
W • 6"
H • 37 3/8"
P • 1 1/8"

FLOWER BELL DROP



Product ID
ONL06X37FL-R
W • 6"
H • 37 3/8"
P • 1 1/8"

MEDIUM FLOWER DROP



Product ID
ONL07X16X01FL
W • 7 1/8"
H • 16"
P • 1 1/8"

LARGE ROSE DROP



Product ID
ONL07X22X02RO
W • 7 1/8"
H • 22"
P • 2"

VERSAILLES DROP



Product ID
ONL08X09X01VE
W • 8 1/2"
H • 9"
P • 3/4"

NADIA DROP



Product ID
ONL09X19NA
W • 9 1/2"
H • 19 7/8"
P • 1 1/4"

ATTICA DROP



Product ID
ONL09X11X01AT
W • 9 1/4"
H • 11 3/4"
P • 1 1/8"

DROPS & SWAGS



SOUTHAMPTON

Product ID	W	H	P
ONL04X02SO	4 1/8"	2"	3/8"

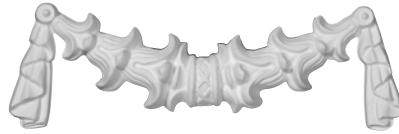

BELL

Product ID	W	H	P
ONL09X03X01BL	9 1/2"	3 1/8"	5/8"



DOLE SWAG

Product ID	W	H	P
ONL09X02DO	9 5/8"	2 1/8"	5/8"



EMERY

Product ID	W	H	P
ONL10X02X01EM	10 1/4"	2 3/8"	5/8"



CENON

Product ID	W	H	P
ONL10X02CE	10 1/4"	2 3/8"	5/8"



FEDERAL SWAG

Product ID	W	H	P
ONL13X05FE	12 5/8"	5 1/8"	5/8"



ROSE SWAG

Product ID	W	H	P
ONL14X07X02RO	14 1/4"	7"	2"



MATERO SWAG

Product ID	W	H	P
ONL16X09MA	16 1/8"	9 7/8"	3/4"



ANTHONY SWAG

Product ID	W	H	P
ONL17X11X01AT	17 1/2"	11"	1 1/2"



ROSE SWAG

Product ID	W	H	P
ONL18X12RO	18 1/4"	12"	2 1/8"



FLORAL SWAG

Product ID	W	H	P
ONL18X07X01FL	18 7/8"	7"	1 3/8"



OSLO

Product ID	W	H	P
ONL18X09X01OS	18"	9"	1 1/4"



BOW & FLOWER

Product ID	W	H	P
ONL19X06BF	19"	6 1/2"	1 1/8"



SALEM FLORAL

Product ID	W	H	P
ONL23X07X02SA	23"	7"	2"



ODESSA

Product ID	W	H	P
ONL24X12X02OD	24"	12"	2 1/2"



DUBLIN

Product ID	W	H	P
ONL24X10X01DU	23 5/8"	10 1/4"	1 3/8"



PALMETTO

Product ID	W	H	P
ONL07X26X01PA	26 1/4"	7 1/4"	1 1/8"



HARVEST

Product ID	W	H	P
ONL07X27X02HA	27 3/8"	7 1/4"	1 5/8"



DUBLIN

Product ID	W	H	P
ONL29X10X01DU	28 7/8"	9 5/8"	1 3/8"



PALMETTO

Product ID	W	H	P
ONL07X31X01PA	30 1/2"	7 3/4"	1"



CLASSIC SWAG

Product ID	W	H	P
ONL32X14CL	31 7/8"	14 1/4"	2"



REECE

Product ID	W	H	P
ONL31X11X02RE	31"	11"	2 1/2"



ROSETTES



ROSETTES



LAURE

Product ID	W	H	P
	•	•	•
ROS01X01LA	1 1/8"	1 1/8"	3/8"



HURLEY

Product ID	W	H	P
	•	•	•
ROS02X02HU	2 1/8"	2 1/8"	3/8"



FLOWER

Product ID	W	H	P
	•	•	•
ROS02X02FL	2 1/2"	2 1/2"	3/8"



NADIA

Product ID	W	H	P
	•	•	•
ROS02X02NA	2 1/2"	2 1/2"	1/2"



BLACKTHORNE

Product ID	W	H	P
	•	•	•
ROS02X02BL	2 3/4"	2 3/4"	3/8"



LOERA

Product ID	W	H	P
	•	•	•
ROS02X02LO	2 3/4"	2 3/4"	1/4"



ARTIS

Product ID	W	H	P
	•	•	•
ROS03X03AR	3"	3"	5/8"



LOGAN

Product ID	W	H	P
	•	•	•
ROS03LO	3 1/8"	3 1/8"	5/8"



MONIQUE

Product ID	W	H	P
	•	•	•
ROS03X03MO	3 1/8"	3 1/8"	5/8"



SOUTHAMPTON

Product ID	W	H	P
	•	•	•
ROS04X03SO	3 3/4"	3 3/4"	5/8"



FLORAL

Product ID	W	H	P
	•	•	•
ROS03X03FL	3 7/8"	3 7/8"	1/2"



SMALL FLOWER

Product ID	W	H	P
	•	•	•
ROS04FL	3 7/8"	3 7/8"	3/4"

ROSETTES



HELENA

Product ID	W	H	P
	•	•	•
ROS03X03HE	3 7/8"	3 7/8"	5/8"



DAMON

Product ID	W	H	P
	•	•	•
ROS04X04X00DA	4"	4"	1/2"



TRADITIONAL

Product ID	W	H	P
	•	•	•
ROS04X01TR	4 1/2"	4 1/2"	3/4"



MARIA

Product ID	W	H	P
	•	•	•
ROS04X04MA	4 3/4"	4 3/4"	1 3/8"



MONIQUE

Product ID	W	H	P
	•	•	•
ROS04X04MO	4 7/8"	4 7/8"	5/8"



BRONTES

Product ID	W	H	P
	•	•	•
ROS05X05BO	5"	5"	5/8"



WORFOLK

Product ID	W	H	P
	•	•	•
ROS05X05NO	5"	5"	1"



FLOWER

Product ID	W	H	P
	•	•	•
ROS05X01FL	5"	5"	3/4"



LISBON

Product ID	W	H	P
	•	•	•
ROS05X00LI	5"	5"	3/8"



BORDEAUX

Product ID	W	H	P
	•	•	•
ROS05X01BO	5"	5"	3/4"



MEDWAY

Product ID	W	H	P
	•	•	•
ROS02X02ME	5 1/2"	5 1/2"	1"



LYRE

Product ID	W	H	P
	•	•	•
ROS05X05LY	5 7/8"	5 7/8"	7/8"

ROSETTES



SUNFLOWER

Product ID	W	H	P
ROS06SN	5 7/8"	5 7/8"	1"



MILLIN

Product ID	W	H	P
ROS05X05MU	5 7/8"	5 7/8"	1 5/8"



CHESTERFIELD

Product ID	W	H	P
ROS06X06CH	6"	6"	1 1/8"



STOCKPORT

Product ID	W	H	P
ROS06X06ST	6 1/2"	6 1/2"	5/8"



PALMETTO

Product ID	W	H	P
ROS06PM	6 3/8"	6 3/8"	1 1/8"



ASHLEY

Product ID	W	H	P
ROS06AS	6 3/8"	6 3/8"	1"

ROSETTES



KEPLER

Product ID W H P
ROS07X07KP 7 1/2" 7 1/2" 7/8"



KENT

Product ID W H P
ROS07X07KE 7 5/8" 7 5/8" 1 3/8"



WAKEFIELD

Product ID W H P
ROS08X08WA 8 5/8" 8 5/8" 5/8"



MADRID

Product ID W H P
ROS04MA 4 3/8" 6 3/4" 5/8"



CLASSICA

Product ID W H P
ROS06X05CL 6 1/8" 4 1/2" 3/8"



KINSELY

Product ID W H P
ROS06X05KI 6 1/8" 4 1/2" 3/4"



MARCELLA

Product ID W H P
ROS07X03MA 7 1/4" 3 3/8" 3/8"



SHELL

Product ID W H P
ROS03X03X01SH 3 1/8" 3 1/8" 5/8"



EMERY

Product ID W H P
ROS03X04EM 3 7/8" 3 7/8" 3/4"



LANARKSHIRE

Product ID W H P
ROS04X04X00LA 5 3/4" 5 3/4" 7/8"



ATTICA

Product ID W H P
ROS01X01AT 1 3/4" 1 3/4" 1 3/4"



FLOWER

Product ID W H P
ROS02X02FW 2" 2" 3/4"

ROSETTES



OXFORD

Product ID	W	H	P
	•	•	•
ROS02X02OX	2 1/2"	2 1/4"	1/2"



SELLEK

Product ID	W	H	P
	•	•	•
ROS03X03SK	3"	3"	1/2"



HOLMDEL

Product ID	W	H	P
	•	•	•
ROS03X03HO	3"	3"	3/8"



FAIRFOX

Product ID	W	H	P
	•	•	•
ROS08X08FA	3 1/8"	3 1/8"	3/4"



DANIELA

Product ID	W	H	P
	•	•	•
ROS03X03DN	3 3/8"	3 3/8"	5/8"



VERSAILLES

Product ID	W	H	P
	•	•	•
ROS04X04VE	3 3/4"	4 3/4"	3/4"



ODESSA

Product ID	W	H	P
	•	•	•
ROS03X03OD	3 7/8"	3 7/8"	7/8"



KENDALL

Product ID	W	H	P
	•	•	•
ROS04X04KD	4"	4"	1"



JACKSON

Product ID	W	H	P
	•	•	•
ROS04X04X00CL	4"	4"	7/8"



LEAF

Product ID	W	H	P
	•	•	•
ROS04X04LE	4 1/8"	4 1/8"	3/4"



FAIRFOX

Product ID	W	H	P
	•	•	•
ROS15X15FA	5 7/8"	5 7/8"	3/4"



ACANTHUS

Product ID	W	H	P
	•	•	•
ROS07X07AC	6 1/8"	6 1/8"	3/4"

STAIR BRACKETS



LEFT ANTONIO

Product ID	W	H	D
SB08X05AN-L	8"	5 7/8"	5/8"



RIGHT ANTONIO

Product ID	W	H	D
SB08X05AN-R	8"	5 7/8"	5/8"



LEFT BREMEN ACANTHUS

Product ID	W	H	D
SB08X05BR-L	8 3/4"	7 5/8"	5/8"



RIGHT BREMEN ACANTHUS

Product ID	W	H	D
SB08X05BR-R	8 3/4"	7 5/8"	5/8"



LEFT SMALL TRADITIONAL

Product ID	W	H	D
SB08X05TR-L	8"	5"	1/2"



RIGHT SMALL TRADITIONAL

Product ID	W	H	D
SB08X05TR-R	8"	5"	1/2"



LEFT TYRONE

Product ID	W	H	D
SB08X05TY-L	8 3/8"	5 7/8"	5/8"



RIGHT TYRONE

Product ID	W	H	D
SB08X05TY-R	8 3/8"	5 7/8"	5/8"

STAIR BRACKETS



LEFT FLOWER

Product ID	W	H	D
SB08X06FL-L	8 5/8"	5 7/8"	5/8"



RIGHT FLOWER

Product ID	W	H	D
SB08X06FL-R	8 5/8"	5 7/8"	5/8"



LEFT PEARL

Product ID	W	H	D
SB08X06PE-L	8"	5 7/8"	3/4"



RIGHT PEARL

Product ID	W	H	D
SB08X06PE-R	8"	5 7/8"	3/4"



LEFT SMALL ASHFORD

Product ID	W	H	D
SB08X07AS-L	8 3/4"	5 7/8"	5/8"



RIGHT SMALL ASHFORD

Product ID	W	H	D
SB08X07AS-R	8 3/4"	5 7/8"	5/8"

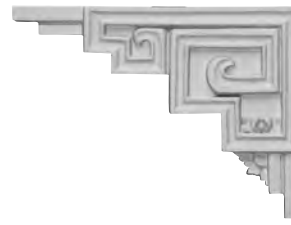

LEFT AUSTIN

Product ID	W	H	D
SB09X06ER-L	9"	5 7/8"	1/2"

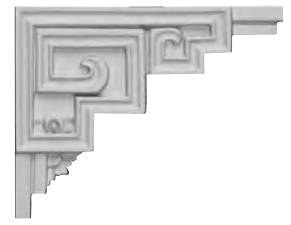

RIGHT AUSTIN

Product ID	W	H	D
SB09X06ER-R	9"	5 7/8"	1/2"



LEFT ABERDEEN

Product ID	W	H	D
SB09X07AB-L	9"	5 7/8"	3/4"



RIGHT ABERDEEN

Product ID	W	H	D
SB09X07AB-R	9"	5 7/8"	3/4"

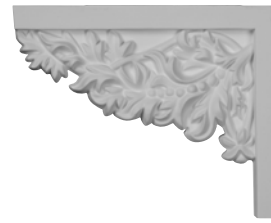

LEFT ATTICA

Product ID	W	H	D
SB09X07AT-L	9"	5 7/8"	3/4"

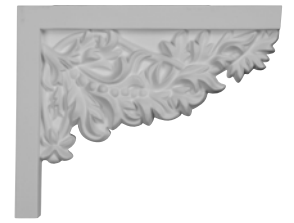

RIGHT ATTICA

Product ID	W	H	D
SB09X07AT-R	9"	5 7/8"	3/4"



LEFT FLORAL

Product ID	W	H	D
SB09X07FL-L	9"	5 7/8"	5/8"



RIGHT FLORAL

Product ID	W	H	D
SB09X07FL-R	9"	5 7/8"	5/8"

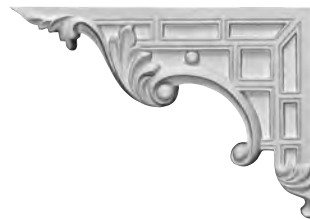

LEFT NESTOR

Product ID	W	H	D
SB09X07NS-L	9"	5 7/8"	5/8"

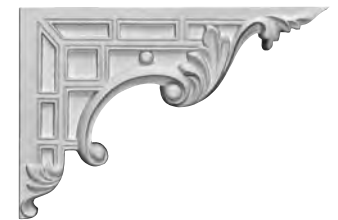

RIGHT NESTOR

Product ID	W	H	D
SB09X07NS-R	9"	5 7/8"	5/8"

STAIR BRACKETS

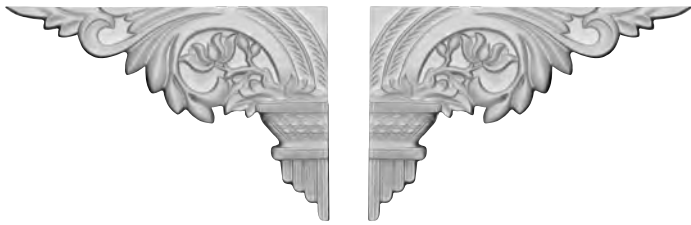

LEFT TELMA

RIGHT TELMA

Product ID W H D
SB10X07TE-L 10 5/8" 5 7/8" 5/8"

Product ID W H D
SB10X07TE-R 10 5/8" 5 7/8" 5/8"

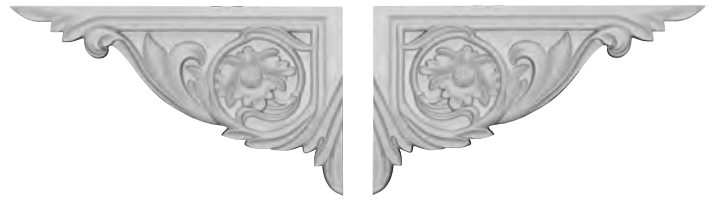

LEFT VINCENT

RIGHT VINCENT

Product ID W H D
SB11X06FVI-L 11" 5 7/8" 5/8"

Product ID W H D
SB11X06VI-R 11" 5 7/8" 5/8"



LEFT LEGACY

RIGHT LEGACY

Product ID W H D
SB11X06LE-L 11" 5 7/8" 1/2"

Product ID W H D
SB11X06LE-R 11" 5 7/8" 1/2"

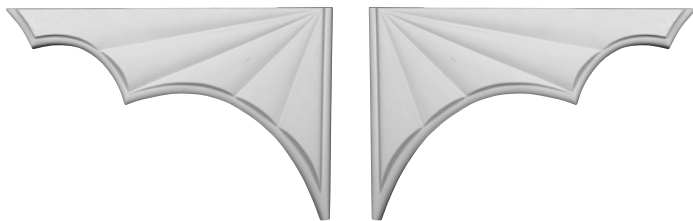

LEFT SALEM

RIGHT SALEM

Product ID W H D
SB11X07SA-L 11 1/4" 7 1/4" 1/2"

Product ID W H D
SB11X07SA-R 11 1/4" 7 1/4" 1/2"

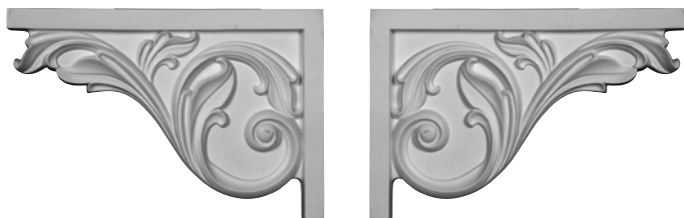

LEFT LARGE ACANTHUS

RIGHT LARGE ACANTHUS

Product ID W H D
SB11X07AC-L 11 3/4" 5 7/8" 3/4"

Product ID W H D
SB11X07AC-R 11 3/4" 5 7/8" 3/4"

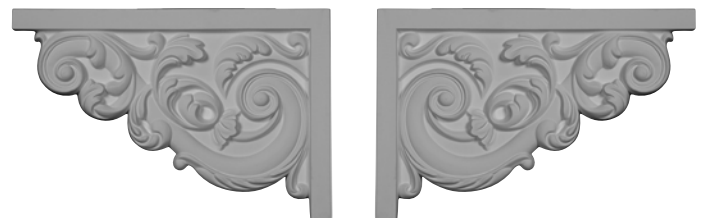

LEFT LARGE ASHFORD

RIGHT LARGE ASHFORD

Product ID W H D
SB11X07AS-L 11 3/8" 5 7/8" 5/8"

Product ID W H D
SB11X07AS-R 11 3/8" 5 7/8" 5/8"

**DRESS UP ANY
 STAIRCASE
 WITH STAIR
 BRACKETS!**

STAIR BRACKETS

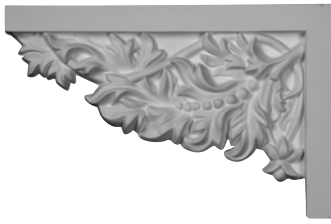

LEFT LARGE ATTICA

Product ID W H D
SB11X07AT-L 11 3/4" 5 7/8" 3/4"

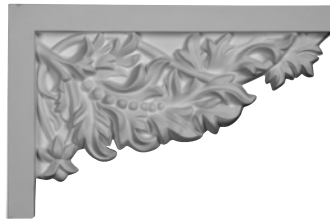

RIGHT LARGE ATTICA

Product ID W H D
SB11X07AT-R 11 3/4" 5 7/8" 3/4"



LEFT LARGE FLORAL

Product ID W H D
SB11X07FL-L 11 3/4" 5 7/8" 3/4"



RIGHT LARGE FLORAL

Product ID W H D
SB11X07FL-R 11 3/4" 5 7/8" 3/4"



LEFT LARGE PEAR

Product ID W H D
SB11X07PE-L 11" 5 7/8" 5/8"



RIGHT LARGE PEAR

Product ID W H D
SB11X07PE-R 11" 5 7/8" 5/8"



LEFT SPRINGTIME

Product ID W H D
SB11X07SP-L 11" 5 7/8" 5/8"



RIGHT SPRINGTIME

Product ID W H D
SB11X07SP-R 11" 5 7/8" 5/8"

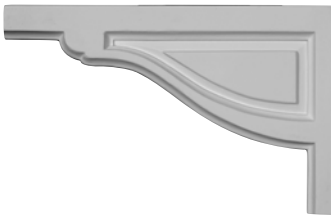

LEFT LARGE TRADITIONAL

Product ID W H D
SB11X07TR-L 11 3/4" 5 7/8" 1/2"

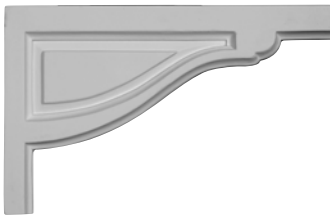

RIGHT LARGE TRADITIONAL

Product ID W H D
SB11X07TR-R 11 3/4" 5 7/8" 1/2"



LEFT SCROLL

Product ID W H D
SB12X06SC-L 12 3/8" 5 7/8" 3/4"



RIGHT SCROLL

Product ID W H D
SB12X06SC-R 12 3/8" 5 7/8" 3/4"



LEFT ASHFORD

Product ID W H D
SB12X07MO-L 12" 5 7/8" 7/8"



RIGHT ASHFORD

Product ID W H D
SB12X07MO-R 12" 5 7/8" 7/8"

USE A GEL STAIN ON THEM TO MATCH YOUR WOOD HANDRAILS OR STAIR TREADS

NICHES



TRADITIONAL RECESSED MOUNT



Product ID
NCH16X27TR

W • 16 5/8"
H • 27 1/2"
D • 7 3/8"
RO: W • 10 1/2"
RO: H • 27 1/2"
RO: D • 7 1/2"

ALEXANDRIA RECESSED MOUNT



Product ID
NCH16X30AL

W • 16 3/8"
H • 30"
D • 8 1/4"
RO: W • 12 3/8"
RO: H • 23 5/8"
RO: D • 4"

KENT RECESSED MOUNT



Product ID
NCH17X30KE

W • 17 7/8"
H • 30 3/8"
D • 8"
RO: W • 16"
RO: H • 25 3/4"
RO: D • 3 3/4"

ASHFORD RECESSED MOUNT



Product ID
NCH17X31AS

W • 17 3/4"
H • 31 1/2"
D • 8 7/8"
RO: W • 11"
RO: H • 24 3/4"
RO: D • 4 7/8"

MEDWAY RECESSED MOUNT



Product ID
NCH18X38ME

W • 16 3/4"
H • 31 1/4"
D • 6 1/4"
RO: W • 12 1/4"
RO: H • 30"
RO: D • 4"

ODESSA RECESSED MOUNT



Product ID
NCH27X38OD

W · 27 1/2"
H · 38 1/4"
D · 8 7/8"
RO: W · 20 7/8"
RO: H · 33 1/2"
RO: D · 4 7/8"

ADONIS RECESSED MOUNT



Product ID
NCH21X39AD

W · 21 3/4"
H · 39 3/8"
D · 9 3/4"
RO: W · 16 3/4"
RO: H · 31 1/8"
RO: D · 4 7/8"

MELONIE RECESSED MOUNT



Product ID
NCH23X43ML

W · 23 5/8"
H · 43 1/2"
D · 6 1/8"
RO: W · 20 2/3"
RO: H · 41 1/4"
RO: D · 7 1/8"

EDWARDS RECESSED MOUNT



Product ID
NCH27X45ED

W · 27 3/8"
H · 45 1/4"
D · 11 3/4"
RO: W · 22 1/4"
RO: H · 39 1/8"
RO: D · 7 1/4"

CLAREMONT RECESSED MOUNT



Product ID
NCH24X49CL

W · 24 3/8"
H · 49 3/4"
D · 16 1/8"
RO: W · 18 7/8"
RO: H · 41 1/8"
RO: D · 7"

BEDFORD RECESSED MOUNT



Product ID
NCH30X50BE

W · 30 1/4"
H · 50"
D · 14 3/8"
RO: W · 18 7/8"
RO: H · 41 1/8"
RO: D · 7"

ARTIS RECESSED MOUNT



Product ID
NCH25X51AT

W · 25"
H · 51 3/8"
D · 13 5/8"
RO: W · 19 1/4"
RO: H · 41"
RO: D · 6 3/4"

BERKSHIRE RECESSED MOUNT



Product ID
NCH35X65BE

W · 35 1/4"
H · 65 1/2"
D · 12 5/8"
RO: W · 31 3/8"
RO: H · 60"
RO: D · 13 1/4"

MARIA SURFACE MOUNT



Product ID
NCH11X20MA

W · 11 3/8"
H · 20"
D · 3 1/4"

NICHES

ADONIS SURFACE MOUNT

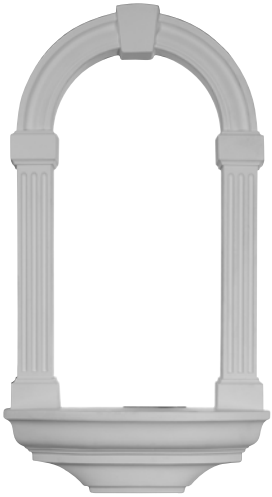

Product ID
NCH16X29AD

W • 16 3/8"

H • 29 7/8"

D • 4 5/8"

SMOOTH SURFACE MOUNT



Product ID
NCH15X31SM

W • 15 1/2"

H • 31 1/2"

D • 7 3/8"

SMALL WALTZ SURFACE MOUNT



Product ID
NCH21X33WA

W • 21 1/8"

H • 33 3/4"

D • 4 1/4"

SHELL SURFACE MOUNT



Product ID
NCH19X37SH

W • 19 5/8"

H • 37 5/8"

D • 8"

EGG & DART FLUTED SURFACE MOUNT



Product ID
NCH27X42EG

W • 27 1/2"

H • 42 1/4"

D • 9"

LARGE WALTZ SURFACE MOUNT



Product ID
NCH30X42WA

W • 30 1/4"

H • 42 5/8"

D • 6 7/8"

HILLSBOROUGH SURFACE MOUNT



Product ID
NCH30X42HI

W • 30 1/4"

H • 42 5/8"

D • 6 7/8"

WALTZ SURFACE MOUNT



Product ID
NCH27X45WA

W • 27 1/2"

H • 45"

D • 7 1/4"

HILLSBOROUGH SURFACE MOUNT



Product ID
NCH27X45HI

W • 27 1/2"

H • 45 3/4"

D • 7 1/4"

REECE SURFACE MOUNT

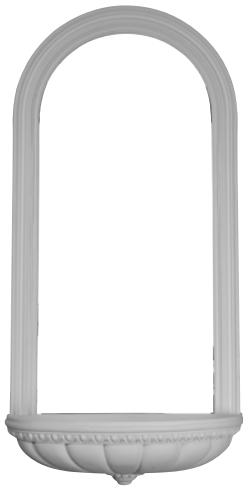

Product ID
NCH24X49RE

W . 24 3/8"

H . 49 3/4"

D . 9"

EMERYVILLE SURFACE MOUNT



Product ID
NCH30X50ER

W . 30 1/4"

H . 50"

D . 7"



SHELF FOR CRENDON NICHE

Product ID	W	H	D
NCH14X06CR	14"	6 7/8"	2 3/4"



SHELF FOR FEDERAL NICHE

Product ID	W	H	D
NCH17X05FE	17 1/4"	5 1/2"	1 7/8"



SHELF FOR DEVON NICHE

Product ID	W	H	D
NCH26X09DE	26 1/2"	9 1/4"	8 1/4"

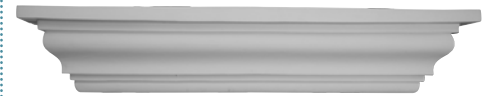

SHELF FOR BERKSHIRE NICHE

Product ID	W	H	D
NCH42X07BE	42 7/8"	7 7/8"	7 7/8"



SHELF FOR DEVON NICHE

Product ID	W	H	D
NCH27X05DE	27 7/8"	5 1/4"	3 3/4"



CAP FOR EDWARDS NICHE

Product ID	W	H	D
NCH37X17ED	37 5/8"	17 3/4"	10 1/4"



SCONCES & SHELVES



TASSEL AND RIBBON SHELF

Product ID	W	H	D
SH09X04X12CH	9 3/4"	12 1/8"	4 1/2"

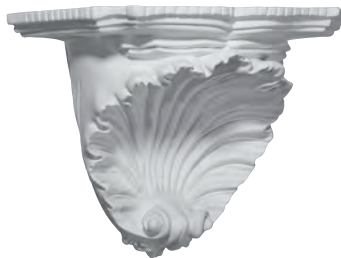

SHELL SHELF

Product ID	W	H	D
SH10X06X07SH	10 3/8"	7 3/8"	6"



HILLSBOROUGH SHELF

Product ID	W	H	D
SH13X06X03HI	13 1/8"	6 5/8"	3 3/4"



TURIN

Product ID	W	H	P
SH09X15X05TU	14 5/8"	8 7/8"	5"



SHELF

Product ID	W	H	D
SH14X16X04HU	15 3/4"	14"	3 7/8"



TASSEL SHELF

Product ID	W	H	D
SH17X09X05CH	17 5/8"	9 1/4"	5 7/8"



HILLSBOROUGH SHELF

Product ID	W	H	D
SH20X06X04HI	20"	6 3/4"	4"



DUNDEE SHELF

Product ID	W	H	D
SH20X10X16DU	20 3/4"	16 7/8"	10 3/8"



ODESSA ACANTHUS LEAF SHELF

Product ID	W	H	D
SH23X07X04OD	23 1/4"	7 1/8"	3 7/8"



ACANTHUS

Product ID	W	H	P
SH08X24X04AC	23 7/8"	7 7/8"	4 3/8"



LARGE WAKEFIELD SHELF

Product ID	W	H	D
SH31X04X08WA	31 1/2"	4 3/4"	7 7/8"



TRADITIONAL SCONCE

Product ID	W	H	D
SCO07X06X16TR	7"	16 1/2"	6 7/8"

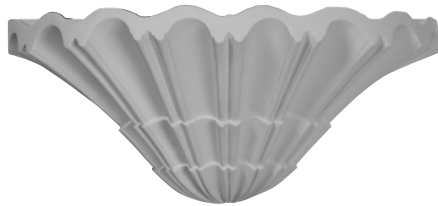

SEA SHELL SCONCE

Product ID	W	H	D
SCO07X08X16SH	7 1/2"	16 1/8"	8"



SPIRAL WALL SCONCE

Product ID	W	H	D
SCO10X05X12SH	10 1/8"	12 1/2"	5 1/2"



SEA SHELL WALL SCONCE

Product ID	W	H	D
SCO10X05X12AS	10 1/8"	12 1/2"	5 1/2"



SHELL WALL SCONCE

Product ID	W	H	D
SCO11X07X06SH	11 3/8"	6 5/8"	7 1/8"



ASHTON WALL SCONCE

Product ID	W	H	D
SCO12X06X04AS	12 1/2"	4 7/8"	6 1/4"



TRADITIONAL WALL SCONCE

Product ID	W	H	D
SCO12X06X04TR	12 3/4"	4 7/8"	6 1/4"

SCONCES



SPANISH WALL SCONCE

Product ID	W	H	D
SCO12X12X18SS	12 3/8"	18 3/8"	12 3/8"



BASIN LEFT WALL SCONCE

Product ID	W	H	D
SCO14X06X06BA	14 1/8"	6"	6 7/8"



ANGEL LEFT WALL SCONCE

Product ID	W	H	D
SCO14X06X15AN-L	14 1/8"	15 1/8"	6 7/8"



ANGEL RIGHT WALL SCONCE

Product ID	W	H	D
SCO14X06X15AN-R	13 7/8"	15 1/8"	6 7/8"



SHELL WALL SCONCE

Product ID	W	H	D
SCO15X04X09SH	15"	9 5/8"	4 5/8"



ASHFORD SHELL WALL SCONCE

Product ID	W	H	D
SCO16X06X08AS	16 1/8"	6 1/4"	8 1/4"



TRADITIONAL WALL SCONCE

Product ID	W	H	D
SCO16X06X08TR	16 1/8"	6 1/4"	8 1/4"



BEADED WALL SCONCE

Product ID	W	H	D
SCO16X08X05BD	16 1/4"	5"	8 1/4"



OAK LEAF WALL SCONCE

Product ID	W	H	D
SCO16X17X08OL	16 1/8"	17 3/4"	8 5/8"



PRINCESS WALL SCONCE

Product ID	W	H	D
SCO16X20X06PR	16 1/2"	20 7/8"	6 3/4"



ROSE LEFT WALL SCONCE

Product ID	W	H	D
SCO17X10X08RO-L	17 3/4"	10 1/4"	8 1/4"



ROSE RIGHT WALL SCONCE

Product ID	W	H	D
SCO17X10X08RO-R	17 3/4"	10 1/4"	8 1/4"



ANGEL

Product ID	W	H	P
SH12X07X07AN	12 1/4"	6 7/8"	6 7/8"



RIBBON WALL SCONCE

Product ID	W	H	D
SCO19X07X06RI	19 1/2"	6 5/8"	7 5/8"



RIBBON WALL SCONCE

Product ID	W	H	D
SCO19X08X06RI	19 7/8"	6 5/8"	7 7/8"



ANGEL WALL SCONCE

Product ID	W	H	D
SCO23X14X09AN	23 5/8"	14 1/8"	9 1/2"



SHELVES

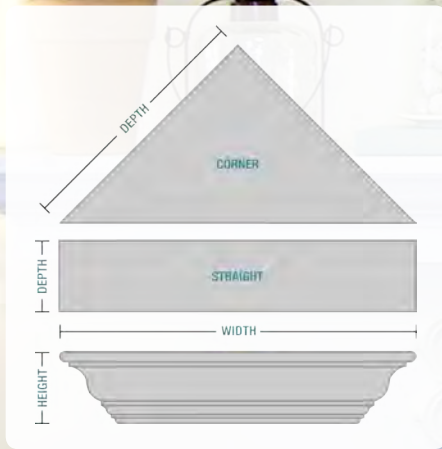

STRAIGHT BACKPLATE

CORNER BACKPLATE



VERSAILLES STRAIGHT

CORNER



SH12X04X04VE D · 4 1/8" H · 4 3/8" W · 12"



SH24X04X04VE D · 4 1/8" H · 4 3/8" W · 24"



SH30X04X04VE D · 4 1/8" H · 4 3/8" W · 30"



SH36X04X04VE D · 4 1/8" H · 4 3/8" W · 36"



SH48X04X04VE D · 4 1/8" H · 4 3/8" W · 48"



SH60X04X04VE D · 4 1/8" H · 4 3/8" W · 60"



SH23X16X04VE D · 16 1/8" H · 4 3/8" W · 22 3/4"

CORNER



SH23X16X04CL D · 16 1/8" H · 4 1/2" W · 22 3/4"

CLASSIC STRAIGHT



SH12X04X04CL D · 4 1/2" H · 4 1/2" W · 12"



SH24X04X04CL D · 4 1/2" H · 4 1/2" W · 24"



SH30X04X04CL D · 4 1/2" H · 4 1/2" W · 30"



SH36X04X04CL D · 4 1/2" H · 4 1/2" W · 36"



SH48X04X04CL D · 4 1/2" H · 4 1/2" W · 48"

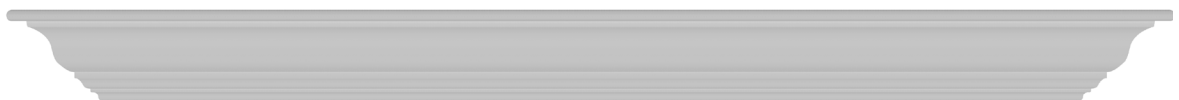

SH60X04X04CL D · 4 1/2" H · 5 1/2" W · 60"

CORNER



SH23X16X03 D · 16 1/4" H · 2 5/8" W · 22 7/8"

CLASSIC MINI STRAIGHT



SH12X03X03CL D · 3 1/8" H · 2 5/8" W · 12"



SH24X03X03CL D · 3 1/8" H · 2 5/8" W · 24"



SH30X03X03CL D · 3 1/8" H · 2 5/8" W · 30"



SH36X03X03CL D · 3 1/8" H · 2 5/8" W · 36"



SH48X03X03CL D · 3 1/8" H · 2 5/8" W · 48"



SH60X03X03CL D · 3 1/8" H · 2 5/8" W · 60"

SHELVES

EGG & DART STRAIGHT



SH12X04X05EG D · 5 1/4" H · 3 7/8" W · 12"



SH24X04X05EG D · 5 1/4" H · 3 7/8" W · 24"



SH30X04X05EG D · 5 1/4" H · 3 7/8" W · 30"



SH36X04X05EG D · 5 1/4" H · 3 7/8" W · 36"



SH48X04X05EG D · 5 1/4" H · 3 7/8" W · 48"



SH60X04X05EG D · 5 1/4" H · 3 7/8" W · 60"

CORNER



SH23X16X04EG D · 16 1/8" H · 3 7/8" W · 22 3/4"

TIRANA STRAIGHT



SH12X05X05TI D · 5 1/8" H · 5 1/2" W · 12"



SH24X05X05TI D · 5 1/8" H · 5 1/2" W · 24"



SH30X05X05TI D · 5 1/8" H · 5 1/2" W · 30"



SH36X05X05TI D · 5 1/8" H · 5 1/2" W · 36"



SH48X05X05TI D · 5 1/8" H · 5 1/2" W · 48"



SH60X05X05TI D · 5 1/8" H · 5 1/2" W · 60"

CORNER



SH23X16X05TI D · 16 1/8" H · 5 3/8" W · 22 3/4"

CORNER



SH23X16X04CL D · 16 1/8" H · 4 1/2" W · 22 3/4"

DENTIL STRAIGHT



SH12X04X04DE D · 4 1/8" H · 4 1/2" W · 12"



SH24X04X04DE D · 4 1/8" H · 4 1/2" W · 24"



SH30X04X04DE D · 4 1/8" H · 4 1/2" W · 30"



SH36X04X04DE D · 4 1/8" H · 4 1/2" W · 36"



SH48X04X04DE D · 4 1/8" H · 4 1/2" W · 48"



SH60X04X04DE D · 4 1/8" H · 4 1/2" W · 60"

CORNER



SH23X16X05TI D · 16 1/8" H · 7 1/4" W · 22 3/4"

VICTORIAN STRAIGHT



SH18X07X09VI D · 5 1/8" H · 5 1/2" W · 12"



SH24X07X09VI D · 5 1/8" H · 5 1/2" W · 24"



SH30X07X09VI D · 5 1/8" H · 5 1/2" W · 30"



SH36X07X09VI D · 5 1/8" H · 5 1/2" W · 36"



SH48X07X09VI D · 5 1/8" H · 5 1/2" W · 48"

WOOD CARVING

Rooted in history these wood carvings exemplify traditional design in a traditional medium. Wood boasts unique character and amazing workability. It has a look unrivaled by anything else while giving the option to be painted or stained to enhance its' beauty. Without question wood carving will draw attention and enhance any home's brilliance.

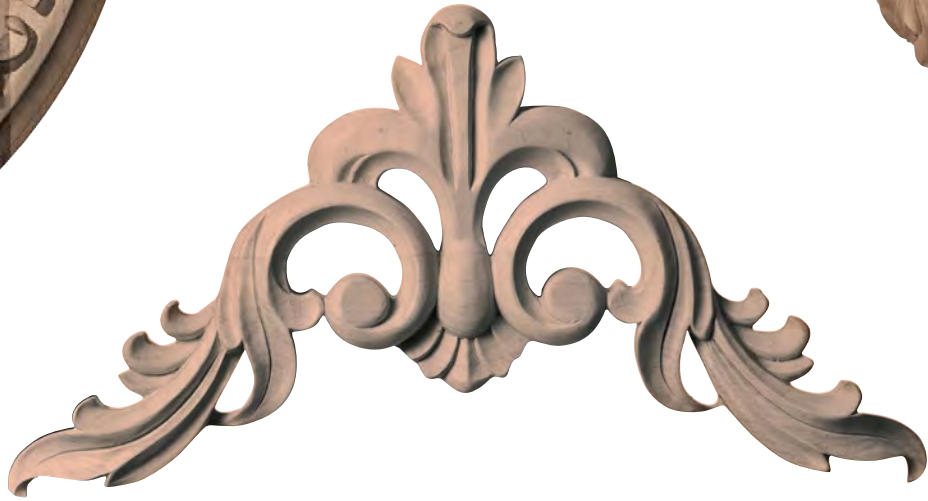

WOOD CORBELS



ACANTHUS

Product ID	W	H	D
CORW02X02X04AC	2 1/4"	4 1/4"	2 1/4"

alder | cherry | maple | red oak | paint grade
mahogany | walnut



ACANTHUS

Product ID	W	H	D
CORW03X04X07AC	3 1/2"	7"	4"

alder | cherry | maple | red oak | paint grade
mahogany | walnut



ACANTHUS

Product ID	W	H	D
CORW05X05X10AC	5"	10"	5"

alder | cherry | maple | red oak | paint grade
mahogany | walnut

WOOD CORBELS



ACANTHUS

Product ID	W	H	D
CORW05X07X14AC	5"	14"	7"

alder | cherry | maple | red oak | paint grade
mahogany | walnut



ACANTHUS

Product ID	W	H	D
CORW08X06X14AC	8 1/2"	14"	6 1/2"

alder | cherry | maple | red oak | paint grade



ACANTHUS

Product ID	W	H	D
CORW06X08X18AC	6"	18"	7 1/2"

alder | cherry | maple | red oak | paint grade
mahogany | walnut



ACANTHUS

Product ID	W	H	D
CORW07X08X22AC	6 1/2"	22"	8"

alder | cherry | maple | red oak | paint grade
mahogany | walnut

ALL CARVINGS SHIP WITHIN
72 HOURS



ACANTHUS

Product ID	W	H	D
CORW07X09X26AC	7"	26"	8 1/2"

alder | cherry | maple | red oak | paint grade
mahogany | walnut



ACANTHUS

Product ID	W	H	D
CORW08X09X30AC	8"	30"	9"

alder | cherry | maple | red oak | paint grade
mahogany | walnut



ACANTHUS

Product ID	W	H	D
CORW09X10X34AC	9"	34"	10"

alder | cherry | maple | red oak | paint grade
mahogany | walnut

WOOD CORBELS



ACANTHUS

Product ID	W	H	D
CORW03X02X06PA	3"	6"	1 3/4"

alder | cherry | maple | red oak | paint grade
mahogany | walnut



ACANTHUS

Product ID	W	H	D
CORW05X02X10PA	4 3/4"	10"	1 3/4"

alder | cherry | maple | red oak | paint grade
mahogany | walnut



ACANTHUS

Product ID	W	H	D
CORW05X03X16PA	5 1/8"	15 1/2"	3 3/8"

alder | cherry | maple | red oak | paint grade
mahogany | walnut



ACANTHUS

Product ID	W	H	D
CORW06X03X22PA	6 1/4"	22"	3"

alder | cherry | maple | red oak | paint grade



ACANTHUS

Product ID	W	H	D
CORW07X04X27PA	6 3/4"	27 1/2"	4 1/4"

alder | cherry | maple | red oak | paint grade





ACANTHUS

Product ID	W	H	D
CORW01X01X03BA	1 3/4"	3"	1 1/2"

alder | cherry | maple | red oak | paint grade



ACANTHUS

Product ID	W	H	D
CORW02X02X04BA	2 1/2"	4"	2 1/4"

alder | cherry | maple | red oak | paint grade



ACANTHUS

Product ID	W	H	D
CORW03X03X05BA	3 1/4"	5"	2 3/4"

alder | cherry | maple | red oak | paint grade



ACANTHUS

Product ID	W	H	D
CORW04X03X06BA	3 3/4"	6"	3 1/4"

alder | cherry | maple | red oak | paint grade



ACANTHUS

Product ID	W	H	D
CORW05X04X07BA	4 1/2"	7"	3 3/4"

alder | cherry | maple | red oak | paint grade

HAVE QUESTIONS
ABOUT WOOD SPECIES?
CALL US!



TRADITIONAL ACANTHUS

Product ID	W	H	D
CORW03X04X07TA	3 1/2"	7"	4"

alder | cherry | maple | red oak | paint grade
mahogany | walnut



TRADITIONAL ACANTHUS

Product ID	W	H	D
CORW04X05X10TA	4 1/2"	10"	5"

alder | cherry | maple | red oak | paint grade
mahogany | walnut



TRADITIONAL ACANTHUS

Product ID	W	H	D
CORW05X07X14TA	5"	14"	7"

alder | cherry | maple | red oak | paint grade
mahogany | walnut

WOOD CORBELS



FARMINGDALE

Product ID	W	H	D
COR03X02X07FR	3 1/2"	7 3/4"	2 7/8"

alder | cherry | lindenwood | maple



FARMINGDALE

Product ID	W	H	D
COR04X02X10FR	4 1/2"	10"	2 3/4"

alder | cherry | lindenwood | maple



FARMINGDALE

Product ID	W	H	D
COR05X04X12FR	5 1/4"	12"	4 3/4"

alder | cherry | lindenwood | maple



FARMINGDALE

Product ID	W	H	D
COR06X03X13FR	6 1/4"	13 1/2"	3 1/8"

alder | cherry | lindenwood | maple



FARMINGDALE

Product ID	W	H	D
COR07X03X20FR	7"	20"	4"

alder | cherry | lindenwood | maple



FARMINGDALE

Product ID	W	H	D
COR08X04X35FR	8 1/4"	35"	4 3/4"

alder | cherry | lindenwood | maple

USE CORBELS FOR SUPPORT OR DECORATION



FARMINGDALE

Product ID	W	H	D
COR08X06X14FR	8"	15"	6 1/2"

alder | cherry | lindenwood | maple



GRAPE

Product ID	W	H	D
CORW04X05X10GR	4 1/2"	10"	5"

alder | cherry | maple | red oak | paint grade
mahogany | walnut



GRAPE

Product ID	W	H	D
COR04X05X10GR	4 7/8"	10 7/8"	5 1/2"

alder | cherry | maple | paint grade
mahogany | walnut



GRAPE

Product ID	W	H	D
CORW05X07X14GR	5"	14"	7"

alder | cherry | maple | red oak | paint grade
mahogany | walnut



HOLMDEL

Product ID	W	H	D
COR04X08X13HO	4 1/4"	13 1/4"	8"

alder | cherry | maple | paint grade

GRAPE CARVINGS INSPIRED BY THE HILLS OF ITALY



GRAPE

Product ID	W	H	D
CORW03X04X07GR	3 1/2"	7"	4"

alder | cherry | maple | red oak | paint grade
mahogany | walnut



GRAPE

Product ID	W	H	D
COR03X04X07GR	3 1/2"	7 7/8"	4 3/8"

alder | cherry | maple | paint grade



GRAPE

Product ID	W	H	D
COR04X08X13DE	4 1/4"	13 1/4"	8"

alder | cherry | maple | paint grade

WOOD CORBELS



FIG LEAF

Product ID	W	H	D
COR02X03X06FI	2 5/8"	6 5/8"	3 3/4"

alder | cherry | maple | lindenwood



FIG LEAF

Product ID	W	H	D
COR03X04X08FI	3 3/4"	8 1/2"	4 3/8"

alder | cherry | maple | lindenwood



FIG LEAF

Product ID	W	H	D
COR04X08X13FI	4 3/4"	13 1/4"	8"

alder | cherry | maple | lindenwood



SHELL

Product ID	W	H	D
CORW03X04X07SH	3 1/2"	7"	4"

alder | cherry | maple | red oak | paint grade



SHELL

Product ID	W	H	D
CORW04X05X10SH	4 1/2"	10"	5"

alder | cherry | maple | red oak | paint grade



SHELL

Product ID	W	H	D
CORW05X07X14SH	5"	14"	7"

alder | cherry | maple | red oak | paint grade



BASKET WEAVE

Product ID	W	H	D
CORW05X07X14BW	5"	14"	7"

alder | cherry | maple | red oak | paint grade



BASKET WEAVE

Product ID	W	H	D
CORW03X04X07BW	3 1/2"	7"	4"

alder | cherry | maple | red oak | paint grade



BASKET WEAVE

Product ID	W	H	D
CORW04X05X10BW	4 1/2"	10"	5"

alder | cherry | maple | red oak | paint grade

WOOD CORBELS



CLASSICAL

Product ID	W	H	D
CORW03X04X07CL	3 1/2"	7"	4"

alder | cherry | maple | red oak | paint grade



CLASSICAL

Product ID	W	H	D
CORW04X05X10CL	4 1/2"	10"	5"

alder | cherry | maple | red oak | paint grade



CLASSICAL

Product ID	W	H	D
CORW05X07X14CL	5"	14"	7"

alder | cherry | maple | red oak | paint grade



TRADITIONAL

Product ID	W	H	D
COR03X06X10TS	3 3/8"	10 1/2"	6 1/2"

alder | cherry | maple | red oak | paint grade
mahogany | walnut



TRADITIONAL

Product ID	W	H	D
COR03X08X13TS	3 7/8"	13"	8"

alder | cherry | maple | red oak | paint grade
mahogany | walnut



HOLLOW BACK

Product ID	W	H	D
COR03X06X10HA	3 3/8"	10 1/2"	6 1/2"

alder | cherry | maple | red oak | paint grade
mahogany | walnut



HOLLOW BACK

Product ID	W	H	D
COR03X08X13HA	3 7/8"	13"	8"

alder | cherry | maple | red oak | paint grade
mahogany | walnut

WOOD CORBELS



TRADITIONAL

Product ID	W	H	D
CORW03X03X07TR	3 1/2"	7"	3"

alder | cherry | maple | red oak | paint grade
mahogany | walnut



TRADITIONAL

Product ID	W	H	D
CORW05X05X10TR	4 1/2"	10"	5"

alder | cherry | maple | red oak | paint grade
mahogany | walnut



TRADITIONAL

Product ID	W	H	D
CORW05X07X14TR	5"	14"	6 3/4"

alder | cherry | maple | red oak | paint grade
mahogany | walnut



TRADITIONAL

Product ID	W	H	D
CORW06X08X18TR	6"	18"	7 1/2"

alder | cherry | maple | red oak | paint grade
mahogany | walnut

OVER
500
WOOD CORBELS



TRADITIONAL

Product ID	W	H	D
CORW07X08X22TR	6 1/2"	22"	8"

alder | cherry | maple | red oak | paint grade
mahogany | walnut



TRADITIONAL

Product ID	W	H	D
CORW07X09X26TR	7"	26"	8 1/2"

alder | cherry | maple | red oak | paint grade
mahogany | walnut



TRADITIONAL

Product ID	W	H	D
CORW08X09X30TR	8"	30"	9"

alder | cherry | maple | red oak | paint grade
mahogany | walnut



TRADITIONAL

Product ID	W	H	D
CORW09X10X34TR	9"	34"	10"

alder | cherry | maple | red oak | paint grade
mahogany | walnut

WOOD CORBELS



TRADITIONAL

Product ID	W	H	D
CORW03X02X06PT	3"	6"	1 3/4"

alder | cherry | maple | red oak | paint grade
mahogany | walnut



TRADITIONAL

Product ID	W	H	D
CORW05X02X10PT	4 3/4"	6"	1 3/4"

alder | cherry | maple | red oak | paint grade
mahogany | walnut



TRADITIONAL

Product ID	W	H	D
CORW05X02X16PT	5 1/8"	15 1/2"	2 3/8"

alder | cherry | maple | red oak | paint grade
mahogany | walnut



TRADITIONAL

Product ID	W	H	D
CORW06X03X22PT	6 1/4"	22"	3"

alder | cherry | maple | red oak | paint grade



TRADITIONAL

Product ID	W	H	D
CORW07X04X27PT	6 3/4"	27 1/2"	4 1/4"

alder | cherry | maple | red oak | paint grade

WOOD CORBELS



DEVON

Product ID	W	H	D
CORW02X02X04DE	2 1/4"	4 1/4"	2 1/4"

alder | cherry | maple | red oak | rubberwood



DEVON

Product ID	W	H	D
CORW04X04X07DE	4"	7 1/2"	4"

alder | cherry | maple | red oak | rubberwood



DEVON

Product ID	W	H	D
CORW05X05X09DE	5 1/4"	9 1/2"	5 1/4"

alder | cherry | maple | red oak | rubberwood



DEVON

Product ID	W	H	D
CORW06X07X13DE	6"	13 1/4"	7"

alder | cherry | maple | red oak | rubberwood



DEVON

Product ID	W	H	D
CORW06X08X16DE	6"	16"	7 1/2"

alder | cherry | maple | red oak | rubberwood



COLE

Product ID	W	H	D
CORW04X02X07CO	4"	7 1/2"	2 1/2"

alder | cherry | maple | red oak | rubberwood



COLE

Product ID	W	H	D
CORW05X03X09CO	5"	9 1/2"	3 1/4"

alder | cherry | maple | red oak | rubberwood



COLE

Product ID	W	H	D
CORW06X04X12CO	6 1/4"	12"	4"

alder | cherry | maple | red oak | rubberwood



COLE

Product ID	W	H	D
CORW07X04X14CO	7 1/2"	14"	4 1/2"

alder | cherry | maple | red oak | rubberwood

WOOD CORBELS



SCROLL

Product ID	W	H	D
COR03X05X09SC	3 1/4"	9"	5"

alder | cherry | maple | red oak | rubberwood



SCROLL

Product ID	W	H	D
COR04X05X12SC	4 1/2"	12"	5 1/2"

alder | cherry | maple | red oak | rubberwood



SCROLL

Product ID	W	H	D
COR05X08X16SC	5 1/2"	16"	8 1/4"

alder | cherry | maple | red oak | rubberwood



SCROLL

Product ID	W	H	D
COR06X10X22SC	6 1/4"	22"	10"

alder | cherry | maple | red oak | rubberwood

**SAME CORBEL
DESIGNS BOTH
IN WOOD
AND URETHANE**



DIANE

Product ID	W	H	D
CORW03X04X08DI	3 1/4"	8"	4"

alder | cherry | maple | red oak | rubberwood



DIANE

Product ID	W	H	D
CORW04X05X10DI	4"	10"	5"

alder | cherry | maple | red oak | rubberwood



DIANE

Product ID	W	H	D
CORW05X06X12DI	4 3/4"	12"	6"

alder | cherry | maple | red oak | rubberwood



DIANE

Product ID	W	H	D
CORW06X07X14DI	5 1/2"	14"	7"

alder | cherry | maple | red oak | rubberwood

WOOD CORBELS



MISSION

Product ID	W	H	D
COR04X05X10TR	4 3/4"	10"	5"

alder | cherry | maple | red oak | rubberwood



MISSION

Product ID	W	H	D
COR06X06X14TR	6 1/2"	14"	6 1/2"

alder | cherry | maple | red oak | rubberwood



MISSION

Product ID	W	H	D
COR07X08X17TR	7 1/2"	17"	8"

alder | cherry | maple | red oak | rubberwood



HOLLOW BACK

Product ID	W	H	D
COR03X07X11HA	3 1/2"	11"	7 1/4"

alder | cherry | maple | red oak | rubberwood

PERFECT
FOR ARTS
& CRAFTS
KITCHENS



HOLLOW BACK

Product ID	W	H	D
COR04X08X13HA	4"	13"	8 1/2"

alder | cherry | maple | red oak | rubberwood



ARTS & CRAFTS

Product ID	W	H	D
COR03X04X14AR	3 7/8"	14"	4 1/2"

alder | cherry | maple | red oak | rubberwood



ARTS & CRAFTS

Product ID	W	H	D
COR06X04X12AR	6"	12"	4 3/4"

alder | cherry | maple | red oak | rubberwood



ARTS & CRAFTS

Product ID	W	H	D
COR06X04X09AR	6"	9"	4"

alder | cherry | maple | red oak | rubberwood

WOOD CORBELS



ARTS & CRAFTS

Product ID	W	H	D
COR04X04X12AR	4"	12"	4"

alder | cherry | maple | red oak | rubberwood



ARTS & CRAFTS

Product ID	W	H	D
COR05X05X09AR	5"	9"	5"

alder | cherry | maple | red oak | rubberwood



ARTS & CRAFTS

Product ID	W	H	D
COR07X07X14AR	7 1/2"	14"	7 1/2"

alder | cherry | maple | red oak | rubberwood



CAPISTRANO

Product ID	W	H	D
COR02X02X04CP	2 1/2"	4 1/2"	2 3/4"

alder | cherry | maple | rubberwood



CAPISTRANO

Product ID	W	H	D
COR03X04X06CP	3 1/2"	6 1/2"	4"

alder | cherry | maple | rubberwood



CAPISTRANO

Product ID	W	H	D
COR04X05X10CP	4 3/4"	10"	5 1/2"

alder | cherry | maple | rubberwood



CAPISTRANO

Product ID	W	H	D
COR05X07X14CP	5 3/4"	14"	7"

alder | cherry | maple | rubberwood



WOOD CORBELS



RAISED FLUTING

Product ID	W	H	D
COR05X05X10RA	5 1/2"	10"	5 1/2"

alder | cherry | maple | red oak | rubberwood



RAISED FLUTING

Product ID	W	H	D
COR06X06X12RA	6 1/2"	12"	6 1/2"

alder | cherry | maple | red oak | rubberwood



FLUTED

Product ID	W	H	D
COR04X04X14RE	4"	14"	4"

alder | cherry | maple | red oak | rubberwood



FLUTED

Product ID	W	H	D
COR04X04X07FL	4 1/4"	7"	4 1/4"

alder | cherry | maple | red oak | rubberwood



FLUTED

Product ID	W	H	D
COR05X05X10FL	5 1/2"	10"	5 1/2"

alder | cherry | maple | red oak | rubberwood



FLUTED

Product ID	W	H	D
COR07X07X13FL	7"	13"	7 1/2"

alder | cherry | maple | red oak | rubberwood



ARLINGTON

Product ID	W	H	D
COR04X10X13AR	4 1/2"	13 3/4"	10"

alder | cherry | maple | red oak | rubberwood



SANTA FE

Product ID	W	H	D
COR05X03X07SF	5"	7"	3"

alder | cherry | maple | red oak | rubberwood



ALPINE

Product ID	W	H	D
COR06X04X11AP	6"	11"	4"

alder | cherry | maple | red oak | rubberwood

WOOD CORBELS



ACANTHUS WITH DENTIL

Product ID	W	H	D
COR05X02X09AC	5 3/4"	9 3/4"	2 3/4"

alder | cherry | maple | red oak | lindenwood



ACANTHUS

Product ID	W	H	D
COR06X03X08AC	6"	8 1/4"	3 1/4"

alder | cherry | maple | red oak | lindenwood



TRADITIONAL

Product ID	W	H	D
COR07X03X10TR	7"	11"	3 1/2"

alder | cherry | maple | red oak | lindenwood



SAN JUAN

Product ID	W	H	D
CORW05X06X10SJ	5"	10 1/2"	6"

alder | cherry | maple | red oak | paint grade

**WE DO
CUSTOM
CARVINGS!**



SAN JUAN

Product ID	W	H	D
CORW05X07X14SJ	5"	14"	7 3/4"

alder | cherry | maple | red oak | paint grade



FLORAL

Product ID	W	H	D
COR03X05X09FL	3 3/4"	9 1/2"	5 1/2"

alder | cherry | maple | red oak | lindenwood



FLORAL

Product ID	W	H	D
COR06X07X14FL	6 1/4"	14 1/8"	7 5/8"

alder | cherry | maple | red oak | lindenwood



ACANTHUS

Product ID	W	H	D
COR05X01X06SH	5 1/4"	6 1/2"	2"

alder | cherry | maple | red oak | lindenwood

WOOD BRACKETS



WOOD BRACKETS



EATON

Product ID	W	H	D
BKTW02X06X06EA	1 3/4"	5 1/2"	5 1/2"

alder | cherry | maple | red oak | paint grade



EATON

Product ID	W	H	D
BKKTW02X08X08EA	1 3/4"	7 1/2"	7 1/2"

alder | cherry | maple | red oak | paint grade



EATON

Product ID	W	H	D
BKTW02X11X11EA	1 3/4"	10 1/2"	10 1/2"

alder | cherry | maple | red oak | paint grade



PLYMOUTH

Product ID	W	H	D
BKTW02X05X08PL	1 3/4"	7 1/2"	5 1/4"

alder | cherry | maple | red oak | paint grade



PLYMOUTH

Product ID	W	H	D
BKTW02X07X10PL	1 3/4"	9 1/2"	7 1/4"

alder | cherry | maple | red oak | paint grade



PLYMOUTH

Product ID	W	H	D
BKTW02X09X11PL	1 3/4"	11"	8 1/2"

alder | cherry | maple | red oak | paint grade



STRATFORD

Product ID	W	H	D
BKTW02X06X06ST	1 3/4"	5 1/2"	5 1/2"

alder | cherry | maple | red oak | paint grade



STRATFORD

Product ID	W	H	D
BKTW08X08X0ST	1 3/4"	7 1/2"	7 1/2"

alder | cherry | maple | red oak | paint grade



STRATFORD

Product ID	W	H	D
BKTW02X10X10ST	1 3/4"	10"	10"

alder | cherry | maple | red oak | paint grade

WOOD BRACKETS



STOCKPORT

Product ID	W	H	D
BKT02X05X07ST	2 1/4"	7"	5"

alder | cherry | maple | red oak | paint grade



STOCKPORT

Product ID	W	H	D
BKT02X06X10ST	2 1/4"	10"	6"

alder | cherry | maple | red oak | paint grade



STOCKPORT

Product ID	W	H	D
BKT02X07X14ST	2 1/4"	14"	7"

alder | cherry | maple | red oak | paint grade



WOOD BRACKETS



CLARKSVILLE

Product ID	W	H	D
BKTW02X04X06CV	1 3/4"	6"	4"

alder | cherry | maple | red oak | paint grade



CLARKSVILLE

Product ID	W	H	D
BKTW02X04X08CV	1 3/4"	8"	4"

alder | cherry | maple | red oak | paint grade



CLARKSVILLE

Product ID	W	H	D
BKTW02X04X10CV	1 3/4"	10"	4"

alder | cherry | maple | red oak | paint grade



CLARKSVILLE

Product ID	W	H	D
BKTW02X06X08CV	1 3/4"	8"	6"

alder | cherry | maple | red oak | paint grade



CLARKSVILLE

Product ID	W	H	D
BKTW02X06X10CV	1 3/4"	10"	6"

alder | cherry | maple | red oak | paint grade



CLARKSVILLE

Product ID	W	H	D
BKTW02X06X12CV	1 3/4"	12"	6"

alder | cherry | maple | red oak | paint grade



CLARKSVILLE

Product ID	W	H	D
BKTW02X08X10CV	1 3/4"	10"	8"

alder | cherry | maple | red oak | paint grade



CLARKSVILLE

Product ID	W	H	D
BKTW02X08X12CV	1 3/4"	12"	8"

alder | cherry | maple | red oak | paint grade



CLARKSVILLE

Product ID	W	H	D
BKTW02X10X12CV	1 3/4"	12"	10"

alder | cherry | maple | red oak | paint grade

WOOD BRACKETS



CLARKSVILLE

Product ID	W	H	D
BKTW04X04X06CV	3 1/2"	6"	4"

alder | cherry | maple | red oak | paint grade



CLARKSVILLE

Product ID	W	H	D
BKTW04X04X08CV	3 1/2"	8"	4"

alder | cherry | maple | red oak | paint grade



CLARKSVILLE

Product ID	W	H	D
BKTW04X06X08CV	3 1/2"	8"	6"

alder | cherry | maple | red oak | paint grade



CLARKSVILLE

Product ID	W	H	D
BKTW04X04X10CV	3 1/2"	10"	4"

alder | cherry | maple | red oak | paint grade



CLARKSVILLE

Product ID	W	H	D
BKTW04X06X10CV	3 1/2"	10"	6"

alder | cherry | maple | red oak | paint grade



CLARKSVILLE

Product ID	W	H	D
BKTW04X08X10CV	3 1/2"	10"	8"

alder | cherry | maple | red oak | paint grade



CLARKSVILLE

Product ID	W	H	D
BKTW04X06X12CV	3 1/2"	12"	6"

alder | cherry | maple | red oak | paint grade



CLARKSVILLE

Product ID	W	H	D
BKTW04X08X12CV	3 1/2"	12"	8"

alder | cherry | maple | red oak | paint grade



CLARKSVILLE

Product ID	W	H	D
BKTW04X10X12CV	3 1/2"	12"	10"

alder | cherry | maple | red oak | paint grade

WOOD BRACKETS



CLARKSVILLE

Product ID	W	H	D
BKTW05X04X06CV	5 1/4"	6"	4"

alder | cherry | maple | red oak | paint grade



CLARKSVILLE

Product ID	W	H	D
BKTW05X04X08CV	5 1/4"	8"	4"

alder | cherry | maple | red oak | paint grade



CLARKSVILLE

Product ID	W	H	D
BKTW05X06X08CV	5 1/4"	8"	6"

alder | cherry | maple | red oak | paint grade



CLARKSVILLE

Product ID	W	H	D
BKTW05X04X10CV	5 1/4"	10"	4"

alder | cherry | maple | red oak | paint grade



CLARKSVILLE

Product ID	W	H	D
BKTW05X06X10CV	5 1/4"	10"	6"

alder | cherry | maple | red oak | paint grade



CLARKSVILLE

Product ID	W	H	D
BKTW05X08X10CV	5 1/4"	10"	8"

alder | cherry | maple | red oak | paint grade



CLARKSVILLE

Product ID	W	H	D
BKTW05X06X12CV	5 1/4"	12"	6"

alder | cherry | maple | red oak | paint grade



CLARKSVILLE

Product ID	W	H	D
BKTW05X08X12CV	5 1/4"	12"	8"

alder | cherry | maple | red oak | paint grade



CLARKSVILLE

Product ID	W	H	D
BKTW05X10X12CV	5 1/4"	12"	10"

alder | cherry | maple | red oak | paint grade

WOOD BRACKETS



BEDFORD

Product ID	W	H	D
BKTW02X05X08BE	1 3/4"	7 1/2"	5"



BEDFORD

Product ID	W	H	D
BKTW02X07X10BE	1 3/4"	9 1/2"	7 1/4"



BEDFORD

Product ID	W	H	D
BKTW02X09X11BE	1 3/4"	11"	8 1/2"



BEDFORD

Product ID	W	H	D
BKTW04X05X08BE	3 1/2"	7 1/2"	5"

alder | cherry | maple | red oak | paint grade



BEDFORD

Product ID	W	H	D
BKTW05X05X08BE	5 1/4"	7 1/2"	5"

alder | cherry | maple | red oak | paint grade



BEDFORD

Product ID	W	H	D
BKTW04X07X10BE	3 1/2"	9 1/2"	7 1/4"

alder | cherry | maple | red oak | paint grade



BEDFORD

Product ID	W	H	D
BKTW05X07X10BE	5 1/4"	9 1/2"	7 1/4"

alder | cherry | maple | red oak | paint grade



BEDFORD

Product ID	W	H	D
BKTW04X09X11BE	3 1/2"	11"	8 1/2"

alder | cherry | maple | red oak | paint grade



BEDFORD

Product ID	W	H	D
BKTW05X09X11BE	5 1/4"	11"	8 1/2"

alder | cherry | maple | red oak | paint grade

WOOD BRACKETS



HAMILTON

Product ID	W	H	D
BKT01X09X11HA	1 1/2"	11"	9"

alder | cherry | maple | red oak | paint grade



HAMILTON

Product ID	W	H	D
BKT02X05X07HA	2 1/4"	7"	5"

alder | cherry | maple | red oak | paint grade



HAMILTON

Product ID	W	H	D
BKT02X09X11HA	2 1/4"	11"	9"

alder | cherry | maple | red oak | paint grade



HAMILTON

Product ID	W	H	D
BKT03X05X07HA	3"	7"	5"

alder | cherry | maple | red oak | paint grade



HAMILTON

Product ID	W	H	D
BKT03X07X09HA	3 1/2"	9"	7"

alder | cherry | maple | red oak | paint grade

WOOD BRACKETS



REECE

Product ID	W	H	D
BKT02X06X07RE	2 1/2"	7 1/2"	6 1/4"

alder | cherry | maple | red oak | paint grade



REECE

Product ID	W	H	D
BKT02X08X08RE	2 1/2"	8 1/4"	8 3/4"

alder | cherry | maple | red oak | paint grade



REECE

Product ID	W	H	D
BKT02X10X10RE	2 1/2"	10 1/4"	10 3/4"

alder | cherry | maple | red oak | paint grade



REECE

Product ID	W	H	D
BKT02X12X12RE	2 1/2"	12 1/4"	12 3/4"

alder | cherry | maple | red oak | paint grade



REECE

Product ID	W	H	D
BKT02X14X14RE	2 1/2"	14 1/4"	14 3/4"

alder | cherry | maple | red oak | paint grade



REECE

Product ID	W	H	D
BKT02X17X17RE	2 1/2"	17 1/4"	17 3/4"

alder | cherry | maple | red oak | paint grade



TRADITIONAL

Product ID	W	H	D
BKT02X06X07TR	2 1/2"	7 1/2"	6 1/4"

alder | cherry | maple | red oak | paint grade



TRADITIONAL

Product ID	W	H	D
BKT02X08X08TR	2 1/2"	8 1/4"	8 3/4"

alder | cherry | maple | red oak | paint grade



TRADITIONAL

Product ID	W	H	D
BKT02X10X10TR	2 1/2"	10 1/4"	10 3/4"

alder | cherry | maple | red oak | paint grade



TRADITIONAL

Product ID	W	H	D
BKT02X12X12TR	2 1/2"	12 1/4"	12 3/4"
alder cherry maple red oak paint grade			



TRADITIONAL

Product ID	W	H	D
BKT02X14X14TR	2 1/2"	14 1/4"	14 3/4"
alder cherry maple red oak paint grade			



TRADITIONAL

Product ID	W	H	D
BKT02X17X17TR	2 1/2"	17 1/4"	17 3/4"
alder cherry maple red oak paint grade			

WE DO CUSTOM BRACKETS



BULWARK

Product ID	W	H	D
BKT01X06X08BU	1 1/2"	8 1/2"	6"
alder cherry maple red oak paint grade			



ANDREA

Product ID	W	H	D
BKT01X07X07AD	1 1/2"	7"	7"
alder cherry maple red oak paint grade			



CRENDON

Product ID	W	H	D
BKT01X12X12CR	1 1/2"	12"	12"
alder cherry maple red oak paint grade			



BULWARK

Product ID	W	H	D
BKT01X10X10AU	1 1/2"	10"	10"
alder cherry maple red oak paint grade			



DOGWOOD

Product ID	W	H	D
ROS03X03X00DG	3"	3"	5/8"

alder | cherry | maple | lindenwood



DOGWOOD

Product ID	W	H	D
ROS03X03DG	3 1/2"	3 1/2"	3/4"

alder | cherry | maple | lindenwood



DOGWOOD

Product ID	W	H	D
ROS05X05DG	5 1/8"	5 1/8"	1"

alder | cherry | maple | lindenwood



EDINBURGH

Product ID	W	H	D
ROS03X03X00ED	3"	3"	5/8"

alder | cherry | maple | lindenwood



EDINBURGH

Product ID	W	H	D
ROS03X03ED	3 1/2"	3 1/2"	3/4"

alder | cherry | maple | lindenwood



EDINBURGH

Product ID	W	H	D
ROS05X05X01ED	5 1/8"	5 1/8"	7/8"

alder | cherry | maple | lindenwood

WOOD ROSETTES



LEAF

Product ID	W	H	D
ROS03X03X00LF	3"	3"	5/8"
alder cherry maple lindenwood			



LEAF

Product ID	W	H	D
ROS03X03LF	3 1/2"	3 1/2"	3/4"
alder cherry maple lindenwood			



LEAF

Product ID	W	H	D
ROS05X05X01LF	5 1/8"	5 1/8"	7/8"
alder cherry maple lindenwood			



MIDDLESBROUGH

Product ID	W	H	D
ROS03X03X00MD	3"	3"	5/8"
alder cherry maple lindenwood			



MIDDLESBROUGH

Product ID	W	H	D
ROS03X03MD	3 1/2"	3 1/2"	3/4"
alder cherry maple lindenwood			



MIDDLESBROUGH

Product ID	W	H	D
ROS05X05X01MD	5 1/8"	5 1/8"	7/8"
alder cherry maple lindenwood			



SUNFLOWER

Product ID	W	H	D
ROS03X03X00SF	3"	3"	5/8"
alder cherry maple lindenwood			



SUNFLOWER

Product ID	W	H	D
ROS03X03X01SF	3 1/2"	3 1/2"	3/4"
alder cherry maple lindenwood			



SUNFLOWER

Product ID	W	H	D
ROS05X05SF	5"	5"	1"
alder cherry maple lindenwood			

WOOD ROSETTES



MEDWAY

Product ID	W	H	D
ROS03X03ME	3"	3"	5/8"

alder | cherry | maple | lindenwood



MEDWAY

Product ID	W	H	D
ROS03X03X01ME	3 1/2"	3 1/2"	3/4"

alder | cherry | maple | lindenwood



MEDWAY

Product ID	W	H	D
ROS05X05ME	5 1/8"	5 1/8"	7/8"

alder | cherry | maple | lindenwood



AUSTIN STAR

Product ID	W	H	D
ROS03X03AU	3 1/2"	3 1/2"	5/8"

alder | cherry | maple | rubberwood



AUSTIN STAR

Product ID	W	H	D
ROS04X04AU	4 1/4"	4 1/4"	3/4"

alder | cherry | maple | rubberwood



AUSTIN STAR

Product ID	W	H	D
ROS05X05AU	5"	5"	3/4"

alder | cherry | maple | rubberwood



AUSTIN STAR

Product ID	W	H	D
ROS06X06AU	6"	6"	1"

alder | cherry | maple | rubberwood



AUSTIN STAR

Product ID	W	H	D
ROS07X07AU	7"	7"	1"

alder | cherry | maple | rubberwood

WOOD ROSETTES



ACANTHUS

Product ID	W	H	D
	•	•	•
ROS02X02AC	2 3/4"	2 3/4"	1/2"

alder | cherry | maple | rubberwood



ACANTHUS

Product ID	W	H	D
	•	•	•
ROS03X03AC	3 1/2"	3 1/2"	5/8"

alder | cherry | maple | rubberwood



ACANTHUS

Product ID	W	H	D
	•	•	•
ROS04X04AC	4 1/4"	4 1/4"	5/8"

alder | cherry | maple | rubberwood



ACANTHUS

Product ID	W	H	D
	•	•	•
ROS05X05AC	5"	5"	3/4"

alder | cherry | maple | rubberwood



ACANTHUS

Product ID	W	H	D
	•	•	•
ROS06X06AC	6 1/2"	6 1/2"	1"

alder | cherry | maple | rubberwood



SPRINGTIME

Product ID	W	H	D
	•	•	•
ROS02X02SP	2 3/4"	2 3/4"	1/4"

alder | cherry | maple | rubberwood



SPRINGTIME

Product ID	W	H	D
	•	•	•
ROS03X03SP	3 1/2"	3 1/2"	1/2"

alder | cherry | maple | rubberwood



SPRINGTIME

Product ID	W	H	D
	•	•	•
ROS04X04SP	4 1/4"	4 1/4"	5/8"

alder | cherry | maple | rubberwood



SPRINGTIME

Product ID	W	H	D
	•	•	•
ROS05X05SP	5"	5"	3/4"

alder | cherry | maple | rubberwood

WOOD ROSETTES



KENT

Product ID **W** **H** **D**
 ROS02X02KE 2 3/4" 2 3/4" 1/2"
 alder | cherry | maple | lindenwood



KENT

Product ID **W** **H** **D**
 ROS03X03KE 3 5/8" 3 5/8" 2/3"
 alder | cherry | maple | lindenwood



KENT

Product ID **W** **H** **D**
 ROS04X04X01KE 4 1/4" 4 1/4" 5/8"
 alder | cherry | maple | lindenwood



KENT

Product ID **W** **H** **D**
 ROS05X05KE 5" 5" 3/4"
 alder | cherry | maple | rubberwood



KENT

Product ID **W** **H** **D**
 ROS06X06X01KE 6 7/8" 6 7/8" 1"
 alder | cherry | maple | rubberwood



KENT

Product ID **W** **H** **D**
 ROS09X09X01KE 9 1/4" 9 1/4" 1 1/8"
 alder | cherry | maple | rubberwood



WOOD ROSETTES



RAYMOND

Product ID	W	H	D
ROS02X02RA	2 3/4"	2 3/4"	1/4"

alder | cherry | maple | rubberwood



RAYMOND

Product ID	W	H	D
ROS03X03RA	3 1/2"	3 1/2"	1/2"

alder | cherry | maple | rubberwood



RAYMOND

Product ID	W	H	D
ROS04X04RA	4 1/4"	4 1/4"	1/2"

alder | cherry | maple | rubberwood



RAYMOND

Product ID	W	H	D
ROS05X05RA	5"	5"	3/4"

alder | cherry | maple | rubberwood

we do
CUSTOM
carvings



BEDFORD

Product ID	W	H	D
ROS02X02BE	2 3/4"	2 3/4"	1/4"

alder | cherry | maple | rubberwood



BEDFORD

Product ID	W	H	D
ROS03X03BE	3 1/2"	3 1/2"	1/2"

alder | cherry | maple | rubberwood



BEDFORD

Product ID	W	H	D
ROS04X04BE	4 1/4"	4 1/4"	5/8"

alder | cherry | maple | rubberwood



BEDFORD

Product ID	W	H	D
ROS05X05BE	5"	5"	3/4"

alder | cherry | maple | rubberwood

WOOD ROSETTES



HILLSBOROUGH

Product ID	W	H	D
ROS02X03HI	2 1/4"	3 7/8"	3/4"
alder cherry maple lindenwood			



HILLSBOROUGH

Product ID	W	H	D
ROS03X04HI	3"	4 3/4"	1"
alder cherry maple lindenwood			



HILLSBOROUGH

Product ID	W	H	D
ROS03X06HI	3 5/8"	6"	1 1/8"
alder cherry maple lindenwood			



OXFORD

Product ID	W	H	D
ONL05X02X01OX	5"	2"	5/8"
alder cherry maple lindenwood			



OXFORD

Product ID	W	H	D
ONL06X02X01OX	6 3/8"	2 3/8"	3/4"
alder cherry maple lindenwood			



OXFORD

Product ID	W	H	D
ONL08X03X01OX	8"	3 1/2"	1"
alder cherry maple lindenwood			



DOVER

Product ID	W	H	D
ONL11X06X01DR	11 5/8"	6 5/8"	1 5/8"
alder cherry maple lindenwood			



DOVER

Product ID	W	H	D
ONL04X07X01DR	4 1/4"	7 1/4"	3/4"
alder cherry maple lindenwood			



DOVER

Product ID	W	H	D
ONL05X09X01DR	5 1/8"	9"	1"
alder cherry maple lindenwood			

WOOD ROSETTES



REESE

Product ID	W	H	D
ROS02X02RE	2 3/4"	2 3/4"	1/4"

alder | cherry | maple | rubberwood



REESE

Product ID	W	H	D
ROS03X03RE	3 1/2"	3 1/2"	1/2"

alder | cherry | maple | rubberwood



REESE

Product ID	W	H	D
ROS04X04RE	4 1/4"	4 1/4"	5/8"

alder | cherry | maple | rubberwood



REESE

Product ID	W	H	D
ROS05X05RE	5"	5"	3/4"

alder | cherry | maple | rubberwood

TRANSFORM YOUR
CABINETS FROM
ORDINARY TO
EXTRAORDINARY



ASHFORD

Product ID	W	H	D
ROS02X04AS	1 7/8"	2 3/4"	1/2"

alder | cherry | maple | rubberwood



ASHFORD

Product ID	W	H	D
ROS03X05AS	2 1/2"	3 1/2"	5/8"

alder | cherry | maple | rubberwood



ASHFORD

Product ID	W	H	D
ROS04X06AS	3"	4 1/4"	5/8"

alder | cherry | maple | rubberwood



ASHFORD

Product ID	W	H	D
ROS05X07AS	3 1/2"	4 7/8"	1"

alder | cherry | maple | rubberwood

WOOD ROSETTES



GALVESTON STAR

Product ID	W	H	D
	•	•	•
ROS02X02GL	2 3/4"	2 3/4"	1/2"

alder | cherry | maple | rubberwood



GALVESTON STAR

Product ID	W	H	D
	•	•	•
ROS03X03GL	3 1/2"	3 1/2"	7/8"

alder | cherry | maple | rubberwood



GALVESTON STAR

Product ID	W	H	D
	•	•	•
ROS04X04GL	4 1/8"	4 1/8"	5/8"

alder | cherry | maple | rubberwood



GALVESTON STAR

Product ID	W	H	D
	•	•	•
ROS05X05GL	5"	5"	3/4"

alder | cherry | maple | rubberwood

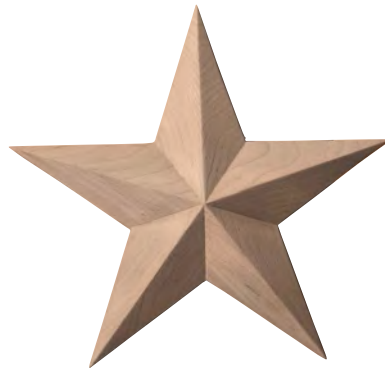

GALVESTON STAR

Product ID	W	H	D
	•	•	•
ROS06X06GL	6 1/2"	6 1/2"	1"

alder | cherry | maple | rubberwood



GALVESTON STAR

Product ID	W	H	D
	•	•	•
ROS07X07GL	7"	7"	1 1/8"

alder | cherry | maple | rubberwood



FOSTER

Product ID	W	H	D
	•	•	•
ONL04X04X01FO	4 1/2"	4 1/2"	1/2"

alder | cherry | maple | lindenwood

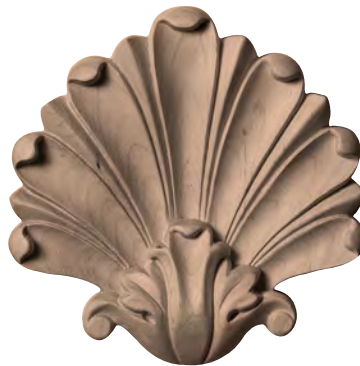

FOSTER

Product ID	W	H	D
	•	•	•
ONL05X05X01FO	5 1/2"	5 1/2"	1/2"

alder | cherry | maple | lindenwood



FOSTER

Product ID	W	H	D
	•	•	•
ONL07X07X01FO	7"	7"	1 3/8"

alder | cherry | maple | lindenwood

WOOD ROSETTES



GRAPE PAIR

Product ID W H D
ONL09X03X01GR 9 1/4" 3 1/2" 5/8"
 alder | cherry | maple | lindenwood



GRAPE PAIR

Product ID W H D
ONL11X04X01GR 11 5/8" 4 5/8" 3/4"
 alder | cherry | maple | lindenwood



GRAPE PAIR

Product ID W H D
ONL14X05X01GR 14 1/2" 5 5/8" 1"
 alder | cherry | maple | lindenwood



SWAYING PAIR

Product ID W H D
ONL09X04X01SW 9 1/8" 4 1/8" 3/4"
 alder | cherry | maple | lindenwood



SWAYING PAIR

Product ID W H D
ONL11X05X01SW 11 1/4" 5 1/8" 1"
 alder | cherry | maple | lindenwood



SWAYING PAIR

Product ID W H D
ONL07X03X01SW 7 1/8" 3 1/8" 5/8"
 alder | cherry | maple | lindenwood

WOOD ROSETTES



SPRINGTIME PAIR

Product ID	W	H	D
ONL07X03X01SP	7 1/2"	3 1/2"	1/2"

alder | cherry | maple | lindenwood



SPRINGTIME PAIR

Product ID	W	H	D
ONL09X04X01SP	9 3/4"	4 3/4"	3/4"

alder | cherry | maple | lindenwood



SPRINGTIME PAIR

Product ID	W	H	D
ONL11X05X01SP	11 1/2"	5 1/2"	1/2"

alder | cherry | maple | lindenwood



ROSE PAIR

Product ID	W	H	D
ONL07X03X01RO	7 1/2"	3 1/2"	1/2"

alder | cherry | maple | lindenwood



ROSE PAIR

Product ID	W	H	D
ONL09X04X01RO	9 3/4"	4 3/4"	3/4"

alder | cherry | maple | lindenwood



ROSE PAIR

Product ID	W	H	D
ONL11X05X01RO	11 1/2"	5 1/2"	1/2"

alder | cherry | maple | lindenwood



BRADFORD

Product ID	W	H	D
ONL12X03X01BR	12"	3 1/4"	5/8"

alder | cherry | maple | lindenwood



BRADFORD

Product ID	W	H	D
ONL25X05X01BR	25"	5 1/8"	3/4"

alder | cherry | maple | lindenwood



BRADFORD

Product ID	W	H	D
ONL36X06X01BR	36 1/2"	6 1/4"	1"

alder | cherry | maple | lindenwood



GREEN LEAF

Product ID	W	H	D
ONL12X03X01LF	12 1/4"	3 1/4"	1/4"
alder cherry maple lindenwood			



GREEN LEAF

Product ID	W	H	D
ONL24X05X01LF	24 3/4"	5 1/8"	3/4"
alder cherry maple lindenwood			



GREEN LEAF

Product ID	W	H	D
ONL36X06X01LF	36 1/2"	6 1/4"	1"
alder cherry maple lindenwood			



MARSEILLE

Product ID	W	H	D
ONL12X03X01MA	12"	3 1/2"	5/8"
alder cherry maple lindenwood			



MARSEILLE

Product ID	W	H	D
ONL24X05X01MA	24 1/2"	5 1/8"	3/4"
alder cherry maple lindenwood			



MARSEILLE

Product ID	W	H	D
ONL36X06X01MA	36"	6 1/4"	1"
alder cherry maple lindenwood			



FARMINGDALE

Product ID	W	H	D
ONL12X03X01FR	12 1/4"	3 1/4"	5/8"
alder cherry maple lindenwood			



FARMINGDALE

Product ID	W	H	D
ONL24X05X01FR	24 1/8"	5 1/8"	3/4"
alder cherry maple lindenwood			



FARMINGDALE

Product ID	W	H	D
ONL36X06X01FR	36 1/2"	6 1/4"	1"
alder cherry maple lindenwood			

WOOD ROSETTES



MONIQUE

Product ID	W	H	D
ONL04X04X01MO	4 1/2"	4 1/2"	1/2"

alder | cherry | maple | lindenwood

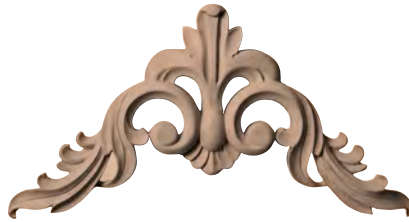

MONIQUE

Product ID	W	H	D
ONL08X08X00MO	8"	8"	3/4"

alder | cherry | maple | lindenwood



MONIQUE

Product ID	W	H	D
ONL10X10X01MO	10"	10"	1"

alder | cherry | maple | lindenwood



CAPUTO

Product ID	W	H	D
ONL04X04X01CA	4"	4"	5/8"

alder | cherry | maple | lindenwood



CAPUTO

Product ID	W	H	D
ONL08X08X01CA	8"	8"	3/4"

alder | cherry | maple | lindenwood



CAPUTO

Product ID	W	H	D
ONL10X10X01CA	8"	8"	1"

alder | cherry | maple | lindenwood



RAYMOND

Product ID	W	H	D
ONL04X04X01RA	4 1/2"	4 1/2"	1/2"

alder | cherry | maple | lindenwood



RAYMOND

Product ID	W	H	D
ONL08X08X00RA	8"	8"	3/4"

alder | cherry | maple | lindenwood

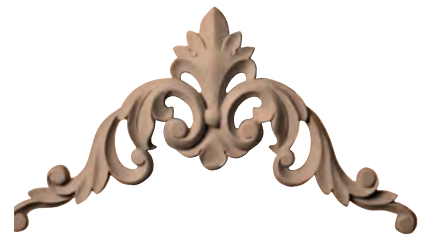

RAYMOND

Product ID	W	H	D
ONL10X10X01RA	10"	10"	1"

alder | cherry | maple | lindenwood

WOOD ROSETTES



KENT

Product ID	W	H	D
ONL12X03X01KE	12"	3 3/8"	3/4"

alder | cherry | maple | lindenwood



KENT

Product ID	W	H	D
ONL16X04X01KE	16"	4 1/8"	1"

alder | cherry | maple | lindenwood



KENT

Product ID	W	H	D
ONL20X05X01KE	20"	5 5/8"	1 1/8"

alder | cherry | maple | lindenwood



FLORAL

Product ID	W	H	D
ONL11X04X01FL	11 1/3"	4 1/3"	1"

alder | cherry | maple | lindenwood



FLORAL

Product ID	W	H	D
ONL16X06X01FL	16 1/8"	6"	1 3/8"

alder | cherry | maple | lindenwood

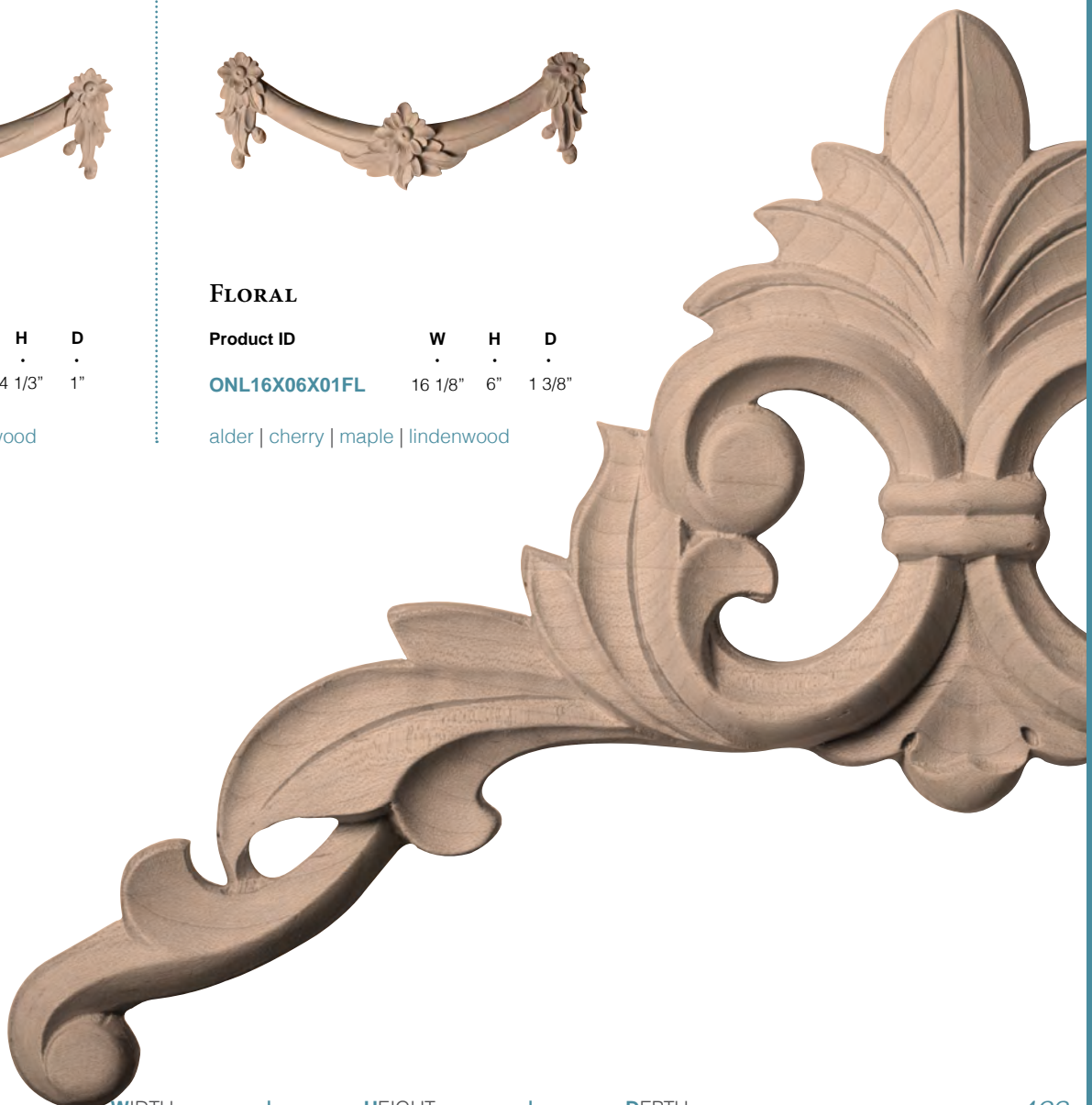

WIDTH | HEIGHT | DEPTH

WOOD CAPITALS & BASES



BRADFORD

Product ID
CAP07X02X05BR



B-W . 3 7/8"
B-D . 1"
W . 7"
H . 5 5/8"
D . 2"

alder | cherry | maple | lindenwood

BRADFORD

Product ID
CAP10X02X07BR



B-W . 5 5/8"
B-D . 1 3/8"
W . 10 3/4"
H . 7 1/2"
D . 2 1/4"

alder | cherry | maple | lindenwood

BRADFORD

Product ID
CAP12X02X09BR



B-W . 6 1/4"
B-D . 2"
W . 12 7/8"
H . 9 1/8"
D . 2 5/8"

alder | cherry | maple | lindenwood

WOOD CAPITALS BASES

CHESTERFIELD

Product ID
CAP06X02X05CH



B-W · 4 3/8"
B-D · 1"
W · 6 1/2"
H · 5 1/2"
D · 2 1/2"

alder | cherry | maple | rubberwood

CHESTERFIELD

Product ID
CAP09X03X07CH



B-W · 6"
B-D · 1 3/8"
W · 9 1/2"
H · 7 5/8"
D · 3 1/8"

alder | cherry | maple | rubberwood

CHESTERFIELD

Product ID
CAP11X03X08CH



B-W · 6 3/4"
B-D · 2"
W · 11"
H · 8 7/8"
D · 3 7/8"

alder | cherry | maple | rubberwood

FLORAL

Product ID
CAP06X02X05FL



B-W · 4 3/8"
B-D · 1"
W · 6 1/4"
H · 5 5/8"
D · 2 1/4"

alder | cherry | maple | rubberwood

FLORAL

Product ID
CAP09X03X08FL



B-W · 6"
B-D · 1 3/8"
W · 9 1/2"
H · 8 3/8"
D · 3 1/4"

alder | cherry | maple | rubberwood

FLORAL

Product ID
CAP11X03X09FL



B-W · 6 3/4"
B-D · 2"
W · 11 1/2"
H · 9 5/8"
D · 3 3/4"

alder | cherry | maple | rubberwood

CHESTERFIELD

Product ID
BAS05X02X06CH



B-W · 4 1/8"
B-D · 1"
W · 5 7/8"
H · 6"
D · 2"

alder | cherry | maple | rubberwood

CHESTERFIELD

Product ID
BAS08X02X07CH



B-W · 5 3/4"
B-D · 1 3/8"
W · 8"
H · 7 7/8"
D · 2 3/8"

alder | cherry | maple | rubberwood

CHESTERFIELD

Product ID
BAS09X03X09CH



B-W · 6 3/8"
B-D · 2"
W · 9 1/4"
H · 9"
D · 3 1/4"

alder | cherry | maple | rubberwood

WOOD CEILING MEDALLIONS

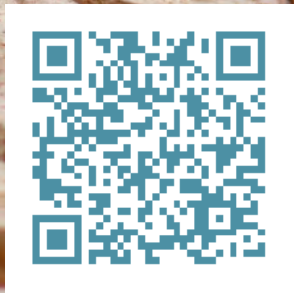

ACANTHUS LEAF

Product ID	OD	ID	P
CMW16AC	16"	0"	1 1/8"

cherry | maple | red oak



ACANTHUS LEAF

Product ID	OD	ID	P
CMW20AC	20"	0"	1 3/4"

cherry | maple | red oak



ACANTHUS LEAF

Product ID	OD	ID	P
CMW24AC	24"	0"	2 1/4"

cherry | maple | red oak

WOOD CEILING MEDALLIONS



BERKSHIRE

Product ID	OD	ID	P
CMW16BE	16"	4"	1 1/8"

cherry | maple | red oak



BERKSHIRE

Product ID	OD	ID	P
CMW20BE	20"	3 7/8"	1 3/4"

cherry | maple | red oak



BERKSHIRE

Product ID	OD	ID	P
CMW24BE	24"	3 7/8"	2 1/4"

cherry | maple | red oak



FLORENTINE

Product ID	OD	ID	P
CMW16FL	16"	3 7/8"	1 1/8"

cherry | maple | red oak



FLORENTINE

Product ID	OD	ID	P
CMW20FL	20"	4"	1 3/4"

cherry | maple | red oak



FLORENTINE

Product ID	OD	ID	P
CMW24FL	24"	3 7/8"	2 1/4"

cherry | maple | red oak



TRADITIONAL

Product ID	OD	ID	P
CMW16TR	16"	0"	1 1/8"

cherry | maple | red oak



TRADITIONAL

Product ID	OD	ID	P
CMW20TR	20"	0"	1 3/4"

cherry | maple | red oak



TRADITIONAL

Product ID	OD	ID	P
CMW24TR	24"	0"	2 1/4"

cherry | maple | red oak

WOOD CABINET COLUMNS



Column Plan Type

- A. Whole
- B. Half
- C. Diagonal Half
- D. Quarter
- E. Quartered



A.



B.



C.



D.



E.



HAMILTON

Product ID

COL03X03X35HA

W • 3 3/4"

H • 35 1/2"

D • 3 3/4"

alder | cherry | maple | rubberwood



HAMILTON

Product ID

COL05X05X35HA

W • 5"

H • 35 1/2"

D • 5"

alder | cherry | maple | rubberwood



KENT

Product ID

COL03X03X35KE

W • 3 3/4"

H • 35 1/2"

D • 3 3/4"

alder | cherry | maple | rubberwood

CABINET COLUMNS



KENT

Product ID

COL05X05X35KE

W • 5"

H • 35 1/2"

D • 5"

alder | cherry | maple | rubberwood



LEGACY

Product ID

COL03X03X35LE

W • 3 3/4"

H • 35 1/2"

D • 3 3/4"

alder | cherry | maple | rubberwood



LEGACY

Product ID

COL05X05X35LE

W • 5"

H • 35 1/2"

D • 5"

alder | cherry | maple | rubberwood



RAYMOND

Product ID

COL03X03X35RA

W • 3 3/4"

H • 35 1/2"

D • 3 3/4"

alder | cherry | maple | rubberwood



RAYMOND

Product ID

COL05X05X35RA

W • 5"

H • 35 1/2"

D • 5"

alder | cherry | maple | rubberwood



RICHMOND

Product ID

COL03X03X35RI

W • 3 3/4"

H • 35 1/2"

D • 3 3/4"

alder | cherry | maple | rubberwood



RICHMOND

Product ID

COL05X05X35RI

W • 5"

H • 35 1/2"

D • 5"

alder | cherry | maple | rubberwood



TRADITIONAL

Product ID

COL03X03X35TR

W • 3 3/4"

H • 35 1/2"

D • 3 3/4"

alder | cherry | maple | rubberwood



TRADITIONAL

Product ID

COL05X05X35TR

W • 5"

H • 35 1/2"

D • 5"

alder | cherry | maple | rubberwood

WOOD CROWN MOULDING



WOOD CROWN MOULDING

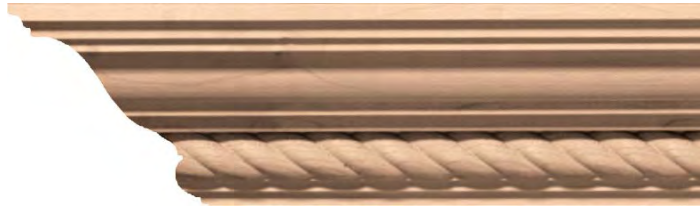

ANDREA

Product ID	H	P	F	L
MLD02X02X03AD	2 1/4"	2 3/8"	3 1/4"	96"

alder | cherry | maple



ANDREA

Product ID	H	P	F	L
MLD03X03X05AD	3 1/2"	3 5/8"	5"	96"

alder | cherry | maple



ANDREA

Product ID	H	P	F	L
MLD04X04X06AD	4 3/4"	4 7/8"	6 3/4"	96"

alder | cherry | maple



ACANTHUS

Product ID	H	P	F	L
MLD02X02X03AC	1 1/8"	2 3/8"	3 1/4"	96"

alder | cherry | maple



ACANTHUS

Product ID	H	P	F	L
MLD03X03X05AC	3 1/4"	3 5/8"	5"	96"

alder | cherry | maple



ACANTHUS

Product ID	H	P	F	L
MLD04X05X06AC	4 1/2"	5"	6 3/4"	96"

alder | cherry | maple



BEDFORD

Product ID	H	P	F	L
MLD03X02X03BE	3"	2 1/4"	3 1/4"	96"

alder | cherry | maple



BEDFORD

Product ID	H	P	F	L
MLD05X04X06BE	5 1/2"	4"	6 3/4"	96"

alder | cherry | maple

HEIGHT

PROJECTION

FACE

LENGTH

WOOD CROWN MOULDING



BEDFORD

Product ID	H	P	F	L
MLD04X02X05BE	4"	2 7/8"	5"	96"

alder | cherry | maple



LANARKSHIRE

Product ID	H	P	F	L
MLD03X03X05LA	3 5/8"	3 1/2"	5"	96"

alder | cherry | maple



LANARKSHIRE

Product ID	H	P	F	L
MLD04X04X06LA	4 7/8"	4 3/4"	6 3/4"	96"

alder | cherry | maple



LANARKSHIRE

Product ID	H	P	F	L
MLD02X02X03LA	5 1/2"	3 3/4"	3 1/4"	96"

alder | cherry | maple



MEDWAY

Product ID	H	P	F	L
MLD02X02X03ME	2 1/4"	2 3/8"	3 1/4"	96"

alder | cherry | maple



MEDWAY

Product ID	H	P	F	L
MLD04X04X06ME	4 3/4"	4 7/8"	6 3/4"	96"

alder | cherry | maple



MEDWAY

Product ID	H	P	F	L
MLD03X03X05ME	3 1/2"	3 5/8"	5"	96"

alder | cherry | maple



**CHECK OUR
URETHANE MOULDING
SECTION FOR
LESS EXPENSIVE
PAINTABLE OPTIONS**



METAL BRACKETS



Metal brackets are our newest product line! The brackets are extremely durable and heavy duty, ready to hold up any counter-top or surface that is put on them. They come in stainless steel as well as rolled steel and are ready to install the moment they arrive. Pre-drilled holes make installation as easy as it gets and all welds are on the back, providing a clean look. All of this combined offers a contemporary, high end, and high quality project that is guaranteed to meet all expectations.

- 1/4 INCH OF STEEL PROVIDES ULTIMATE SUPPORT
- PRE-DRILLED HOLES MAKE INSTALLATION AS EASY AS IT GETS!
- GREAT FOR SUPPORTING COUNTERTOPS AND SHELVES
- BOTH STEEL AND BRUSHED STAINLESS STEEL OPTIONS
- ALL WELDS ARE ON THE BACK FOR A CLEAN AND FINISHED LOOK
- IN STOCK AND SHIPS WITHING 24 HOURS

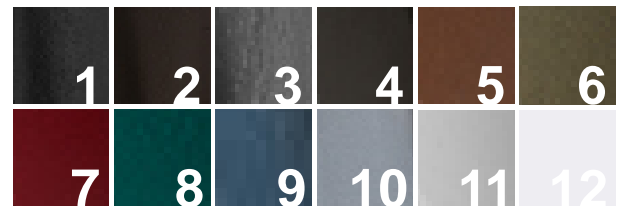

1. Hammered Black
2. Hammered Dark Bronze
3. Hammered Gray
4. Hammered Brown
5. Hammered Copper
6. Hammered Gold
7. Hammered Bright Red
8. Hammered Deep Green
9. Hammered Light Blue
10. Hammered Silver
11. Hammered White
12. Primed

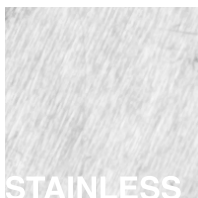

STEEL VS. STAINLESS STEEL?

The main differences between Steel and Stainless Steel are the corrosion resistance of stainless as compared to raw steel (or cold rolled steel). Stainless resists corrosion and does not require finish treatment to prevent rusting. Raw steel does require a finish such as painting, plating or galvanizing in order to inhibit rusting.

METAL BRACKETS



TRADITIONAL

Product ID	W	H	D
BKTM02X08X08TR	2"	8"	8"

Zinc Plated Steel | Brushed Stainless Steel
Painted or Primed

TRADITIONAL

Product ID	W	H	D
BKTM02X10X10TR	2"	10"	10"

Zinc Plated Steel | Brushed Stainless Steel
Painted or Primed



TRADITIONAL

Product ID	W	H	D
BKTM02X12X12TR	2"	12"	12"

Zinc Plated Steel | Brushed Stainless Steel
Painted or Primed



TRADITIONAL

Product ID	W	H	D
BKTM02X14X14TR	2"	14"	14"

Zinc Plated Steel | Brushed Stainless Steel
Painted or Primed



TRADITIONAL

Product ID	W	H	D
BKTM02X16X16TR	2"	16"	16"

Zinc Plated Steel | Brushed Stainless Steel
Painted or Primed



TRADITIONAL

Product ID	W	H	D
BKTM02X18X18TR	2"	18"	18"

Zinc Plated Steel | Brushed Stainless Steel
Painted or Primed



TRADITIONAL

Product ID	W	H	D
BKTM02X20X20TR	2"	20"	20"

Zinc Plated Steel | Brushed Stainless Steel
Painted or Primed



TRADITIONAL

Product ID	W	H	D
BKTM02X24X24TR	2"	24"	24"

Zinc Plated Steel | Brushed Stainless Steel
Painted or Primed

METAL BRACKETS



LEGACY

Product ID	W	H	D
BKTM02X08X08LE	2"	8"	8"

Zinc Plated Steel | Brushed Stainless Steel
Painted or Primed



LEGACY

Product ID	W	H	D
BKTM02X10X10LE	2"	10"	10"

Zinc Plated Steel | Brushed Stainless Steel
Painted or Primed



LEGACY

Product ID	W	H	D
BKTM02X12X12LE	2"	12"	12"

Zinc Plated Steel | Brushed Stainless Steel
Painted or Primed



LEGACY

Product ID	W	H	D
BKTM02X14X14LE	2"	14"	14"

Zinc Plated Steel | Brushed Stainless Steel
Painted or Primed



LEGACY

Product ID	W	H	D
BKTM02X16X16LE	2"	16"	16"

Zinc Plated Steel | Brushed Stainless Steel
Painted or Primed



LEGACY

Product ID	W	H	D
BKTM02X18X18LE	2"	18"	18"

Zinc Plated Steel | Brushed Stainless Steel
Painted or Primed



LEGACY

Product ID	W	H	D
BKTM02X20X20LE	2"	20"	20"

Zinc Plated Steel | Brushed Stainless Steel
Painted or Primed



LEGACY

Product ID	W	H	D
BKTM02X24X24LE	2"	24"	24"

Zinc Plated Steel | Brushed Stainless Steel
Painted or Primed

METAL BRACKETS



BRADFORD

Product ID	W	H	D
BKTM02X07X07BR	2"	7"	7"

Zinc Plated Steel | Brushed Stainless Steel
Painted or Primed



BRADFORD

Product ID	W	H	D
BKTM02X09X09BR	2"	9"	9"

Zinc Plated Steel | Brushed Stainless Steel
Painted or Primed



BRADFORD

Product ID	W	H	D
BKTM02X11X11BR	2"	11"	11"

Zinc Plated Steel | Brushed Stainless Steel
Painted or Primed



METAL BRACKETS



BULWARK

Product ID	W	H	D
BKTM02X08X08BU	2"	8"	8"

Zinc Plated Steel | Brushed Stainless Steel
Painted or Primed



BULWARK

Product ID	W	H	D
BKTM02X10X10BU	2"	10"	10"

Zinc Plated Steel | Brushed Stainless Steel
Painted or Primed



BULWARK

Product ID	W	H	D
BKTM02X12X12BU	2"	12"	12"

Zinc Plated Steel | Brushed Stainless Steel
Painted or Primed



BULWARK

Product ID	W	H	D
BKTM02X14X14BU	2"	14"	14"

Zinc Plated Steel | Brushed Stainless Steel
Painted or Primed



BULWARK

Product ID	W	H	D
BKTM02X16X16BU	2"	16"	16"

Zinc Plated Steel | Brushed Stainless Steel
Painted or Primed



BULWARK

Product ID	W	H	D
BKTM02X18X18BU	2"	18"	18"

Zinc Plated Steel | Brushed Stainless Steel
Painted or Primed



BULWARK

Product ID	W	H	D
BKTM02X20X20BU	2"	20"	20"

Zinc Plated Steel | Brushed Stainless Steel
Painted or Primed



BULWARK

Product ID	W	H	D
BKTM02X24X24BU	2"	24"	24"

Zinc Plated Steel | Brushed Stainless Steel
Painted or Primed

METAL BRACKETS



HEATON

Product ID	W	H	D
BKTM03X10X02HE	3"	2"	10"

Zinc Plated Steel | Brushed Stainless Steel
Painted or Primed



HEATON

Product ID	W	H	D
BKTM03X12X02HE	3"	2"	12"

Zinc Plated Steel | Brushed Stainless Steel
Painted or Primed



HEATON

Product ID	W	H	D
BKTM03X14X02HE	3"	2"	14"

Zinc Plated Steel | Brushed Stainless Steel
Painted or Primed



HEATON

Product ID	W	H	D
BKTM03X16X02HE	3"	2"	16"

Zinc Plated Steel | Brushed Stainless Steel
Painted or Primed



HEATON

Product ID	W	H	D
BKTM03X18X02HE	3"	2"	18"

Zinc Plated Steel | Brushed Stainless Steel
Painted or Primed



HEATON

Product ID	W	H	D
BKTM03X20X02HE	3"	2"	20"

Zinc Plated Steel | Brushed Stainless Steel
Painted or Primed



HEATON

Product ID	W	H	D
BKTM03X24X02HE	3"	2"	24"

Zinc Plated Steel | Brushed Stainless Steel
Painted or Primed

METAL BRACKETS



HAMILTON

Product ID	W	H	D
BKTM02X08X08HA	2"	8"	8"

Zinc Plated Steel | Brushed Stainless Steel
Painted or Primed



HAMILTON

Product ID	W	H	D
BKTM02X10X10HA	2"	10"	10"

Zinc Plated Steel | Brushed Stainless Steel
Painted or Primed



HAMILTON

Product ID	W	H	D
BKTM02X12X12HA	2"	12"	12"

Zinc Plated Steel | Brushed Stainless Steel
Painted or Primed



HAMILTON

Product ID	W	H	D
BKTM02X14X14HA	2"	14"	14"

Zinc Plated Steel | Brushed Stainless Steel
Painted or Primed



HAMILTON

Product ID	W	H	D
BKTM02X16X16HA	2"	16"	16"

Zinc Plated Steel | Brushed Stainless Steel
Painted or Primed



HAMILTON

Product ID	W	H	D
BKTM02X18X18HA	2"	18"	18"

Zinc Plated Steel | Brushed Stainless Steel
Painted or Primed



HAMILTON

Product ID	W	H	D
BKTM02X20X20HA	2"	20"	20"

Zinc Plated Steel | Brushed Stainless Steel
Painted or Primed



HAMILTON

Product ID	W	H	D
BKTM02X24X24HA	2"	24"	24"

Zinc Plated Steel | Brushed Stainless Steel
Painted or Primed

METAL BRACKETS

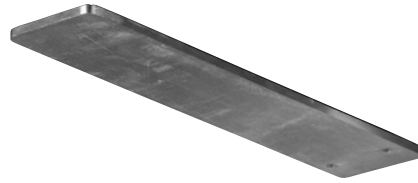

LOGAN

Product ID	W	D	8" Support Overhang
BKTM03X12LO	3"	12"	

Zinc Plated Steel | Brushed Stainless Steel
Painted or Primed

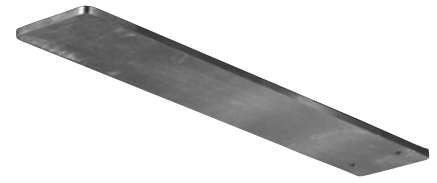

LOGAN

Product ID	W	D	10" Support Overhang
BKTM03X14LO	3"	14"	

Zinc Plated Steel | Brushed Stainless Steel
Painted or Primed



LOGAN

Product ID	W	D	12" Support Overhang
BKTM03X16LO	3"	16"	

Zinc Plated Steel | Brushed Stainless Steel
Painted or Primed

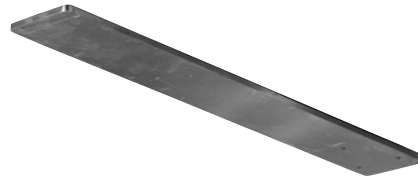

LOGAN

Product ID	W	D	14" Support Overhang
BKTM03X18LO	3"	18"	

Zinc Plated Steel | Brushed Stainless Steel
Painted or Primed

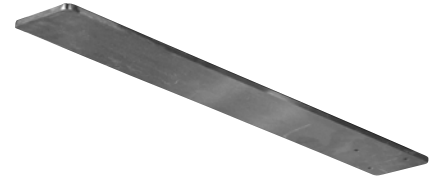

LOGAN

Product ID	W	D	16" Support Overhang
BKTM03X20LO	3"	20"	

Zinc Plated Steel | Brushed Stainless Steel
Painted or Primed

USE OUR
HIDDEN BRACKETS
 TO CREATE THE ILLUSION OF
FLOATING COUNTERTOPS!

METAL BRACKETS



STOCKPORT

Product ID	W	H	D
BKTM02X08X08ST	2"	8"	8"

Zinc Plated Steel | Brushed Stainless Steel
Painted or Primed



STOCKPORT

Product ID	W	H	D
BKTM02X10X10ST	2"	10"	10"

Zinc Plated Steel | Brushed Stainless Steel
Painted or Primed



STOCKPORT

Product ID	W	H	D
BKTM02X12X12ST	2"	12"	12"

Zinc Plated Steel | Brushed Stainless Steel
Painted or Primed



STOCKPORT

Product ID	W	H	D
BKTM02X14X14ST	2"	14"	14"

Zinc Plated Steel | Brushed Stainless Steel
Painted or Primed



STOCKPORT

Product ID	W	H	D
BKTM02X16X16ST	2"	16"	16"

Zinc Plated Steel | Brushed Stainless Steel
Painted or Primed



STOCKPORT

Product ID	W	H	D
BKTM02X18X18ST	2"	18"	18"

Zinc Plated Steel | Brushed Stainless Steel
Painted or Primed

PAINTED COLOR OPTIONS



1. Hammered Black 2. Hammered White 3. Hammered Gray 4. Hammered Copper 5. Hammered Brown 6. Hammered Bronze
7. Hammered Red 8. Hammered Gold 9. Hammered Green 10. Hammered Blue 11. Hammered Silver



7.



8.



9.



10.



11.

IRON BRACKETS



EMERY

Product ID

BKTM01X07X10SEM

Single Center Brace

W	H	D
1 1/2"	10"	7 1/2"



EMERY

Product ID

BKTM02X07X10TEM

Triple Center Brace

W	H	D
2"	10"	7 1/2"



EMERY

Product ID

BKTM01X10X12SEM

Single Center Brace

W	H	D
1 1/2"	12"	10"

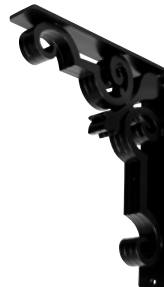

EMERY

Product ID

BKTM02X10X12TEM

Triple Center Brace

W	H	D
2"	12"	10"



EMERY

Product ID

BKTM01X12X15SEM

Single Center Brace

W	H	D
1 1/2"	15"	12"



EMERY

Product ID

BKTM02X12X15TEM

Triple Center Brace

W	H	D
2"	15"	12"

IRON BRACKETS



HAVEN

Product ID

BKTM01X05X08SHA

Single Center Brace

W	H	D
1 1/2"	8"	5 1/2"



HAVEN

Product ID

BKTM02X05X08THA

Triple Center Brace

W	H	D
2"	8"	5 1/2"



HAVEN

Product ID

BKTM01X07X10SHA

Single Center Brace

W	H	D
1 1/2"	10"	7 1/2"



HAVEN

Product ID

BKTM02X07X10THA

Triple Center Brace

W	H	D
2"	10"	7 1/2"



HAVEN

Product ID

BKTM01X10X12SHA

Single Center Brace

W	H	D
1 1/2"	12"	10"



HAVEN

Product ID

BKTM02X10X12THA

Triple Center Brace

W	H	D
2"	12"	10"



HAVEN

Product ID

BKTM01X12X15SHA

Single Center Brace

W	H	D
1 1/2"	15"	12"



HAVEN

Product ID

BKTM02X12X15THA

Triple Center Brace

W	H	D
2"	15"	12"

IRON BRACKETS



DEVON

Product ID

W

H

D

BKTM01X05X08SDE

1 1/2"

8"

5 1/2"

Single Center Brace



DEVON

Product ID

W

H

D

BKTM02X05X08TDE

2"

8"

5 1/2"

Triple Center Brace



DEVON

Product ID

W

H

D

BKTM01X07X10SDE

1 1/2"

10"

7 1/2"

Single Center Brace



DEVON

Product ID

W

H

D

BKTM02X07X10TDE

2"

10"

7 1/2"

Triple Center Brace



DEVON

Product ID

W

H

D

BKTM01X10X12SDE

1 1/2"

12"

10"

Single Center Brace



DEVON

Product ID

W

H

D

BKTM02X10X12TDE

2"

12"

10"

Triple Center Brace



DEVON

Product ID

W

H

D

BKTM01X12X15SDE

1 1/2"

15"

12"

Single Center Brace



DEVON

Product ID

W

H

D

BKTM02X12X15TDE

2"

15"

12"

Triple Center Brace

IRON BRACKETS



FOSTER

Product ID

BKTM01X05X08SFO

Single Center Brace

W	H	D
1 1/2"	8"	5 1/2"



FOSTER

Product ID

BKTM02X05X08TFO

Triple Center Brace

W	H	D
2"	8"	5 1/2"



FOSTER

Product ID

BKTM01X07X10SFO

Single Center Brace

W	H	D
1 1/2"	10"	7 1/2"



FOSTER

Product ID

BKTM02X07X10TFO

Triple Center Brace

W	H	D
2"	10"	7 1/2"



FOSTER

Product ID

BKTM01X10X12SFO

Single Center Brace

W	H	D
1 1/2"	12"	10"



FOSTER

Product ID

BKTM02X10X12TFO

Triple Center Brace

W	H	D
2"	12"	10"



FOSTER

Product ID

BKTM01X12X15SFO

Single Center Brace

W	H	D
1 1/2"	15"	12"



FOSTER

Product ID

BKTM02X12X15TFO

Triple Center Brace

W	H	D
2"	15"	12"

IRON BRACKETS



MEDWAY

Product ID	W	H	D
BKTM01X05X08SME	1 1/2"	8"	5 1/2"

Single Center Brace



MEDWAY

Product ID	W	H	D
BKTM02X05X08TME	2"	8"	5 1/2"

Triple Center Brace



MEDWAY

Product ID	W	H	D
BKTM01X10X12SME	1 1/2"	12"	10"

Single Center Brace



MEDWAY

Product ID	W	H	D
BKTM02X07X10TME	2"	10"	7 1/2"

Triple Center Brace



MEDWAY

Product ID	W	H	D
BKTM01X07X10SME	1 1/2"	10"	7 1/2"

Single Center Brace



MEDWAY

Product ID	W	H	D
BKTM02X10X12TME	2"	12"	10"

Triple Center Brace



MEDWAY

Product ID	W	H	D
BKTM01X12X15SME	1 1/2"	15"	12"

Single Center Brace



MEDWAY

Product ID	W	H	D
BKTM02X12X15TME	2"	15"	12"

Triple Center Brace

IRON BRACKETS



OXFORD

Product ID

BKTM01X05X08SOX

Single Center Brace

W	H	D
1 1/2"	8"	5 1/2"



OXFORD

Product ID

BKTM02X05X08TOX

Triple Center Brace

W	H	D
2"	8"	5 1/2"



OXFORD

Product ID

BKTM01X07X10SOX

Single Center Brace

W	H	D
1 1/2"	10"	7 1/2"



OXFORD

Product ID

BKTM02X07X10TOX

Triple Center Brace

W	H	D
2"	10"	7 1/2"



OXFORD

Product ID

BKTM01X10X12SOX

Single Center Brace

W	H	D
1 1/2"	12"	10"



OXFORD

Product ID

BKTM02X10X12TOX

Triple Center Brace

W	H	D
2"	12"	10"



OXFORD

Product ID

BKTM01X12X15SOX

Single Center Brace

W	H	D
1 1/2"	15"	12"



OXFORD

Product ID

BKTM02X12X15TOX

Triple Center Brace

W	H	D
2"	15"	12"

IRON BRACKETS



ATTICA

Product ID

W	H	D
1 1/2"	8"	5 1/2"

BKTM01X05X08SAT

Single Center Brace



ATTICA

Product ID

W	H	D
2"	8"	5 1/2"

BKTM02X05X08TAT

Triple Center Brace



ATTICA

Product ID

W	H	D
1 1/2"	10"	7 1/2"

BKTM01X07X10SAT

Single Center Brace



ATTICA

Product ID

W	H	D
2"	10"	7 1/2"

BKTM02X07X10TAT

Triple Center Brace



ATTICA

Product ID

W	H	D
1 1/2"	12"	10"

BKTM01X10X12SAT

Single Center Brace



ATTICA

Product ID

W	H	D
2"	12"	10"

BKTM02X10X12TAT

Triple Center Brace



ATTICA

Product ID

W	H	D
1 1/2"	15"	12"

BKTM01X12X15SAT

Single Center Brace



ATTICA

Product ID

W	H	D
2"	15"	12"

BKTM02X12X15TAT

Triple Center Brace

IRON BRACKETS



ASHFORD

Product ID

BKT01X05X08SAS

Single Center Brace

W	H	D
1 1/2"	8"	5 1/2"



ASHFORD

Product ID

BKT02X05X08TAS

Triple Center Brace

W	H	D
2"	8"	5 1/2"



ASHFORD

Product ID

BKT01X07X10SAS

Single Center Brace

W	H	D
1 1/2"	10"	7 1/2"



ASHFORD

Product ID

BKT02X07X10TAS

Triple Center Brace

W	H	D
2"	10"	7 1/2"



ASHFORD

Product ID

BKT01X10X12SAS

Single Center Brace

W	H	D
1 1/2"	12"	10"



ASHFORD

Product ID

BKT02X10X12TAS

Triple Center Brace

W	H	D
2"	12"	10"



ASHFORD

Product ID

BKT01X12X15SAS

Single Center Brace

W	H	D
1 1/2"	15"	12"



ASHFORD

Product ID

BKT02X12X15TAS

Triple Center Brace

W	H	D
2"	15"	12"

IRON BRACKETS



BEDFORD

Product ID	W	H	D
BKTM01X05X08SBE	1 1/2"	8"	5 1/2"

Single Center Brace



BEDFORD

Product ID	W	H	D
BKTM02X05X08TBE	2"	8"	5 1/2"

Triple Center Brace



BEDFORD

Product ID	W	H	D
BKTM01X07X10SBE	1 1/2"	10"	7 1/2"

Single Center Brace



BEDFORD

Product ID	W	H	D
BKTM02X10X12TBE	2"	12"	10"

Triple Center Brace



BEDFORD

Product ID	W	H	D
BKTM01X10X12SBE	1 1/2"	12"	10"

Single Center Brace



BEDFORD

Product ID	W	H	D
BKTM02X07X10TBE	2"	10"	7 1/2"

Triple Center Brace



BEDFORD

Product ID	W	H	D
BKTM01X12X15SBE	1 1/2"	15"	12"

Single Center Brace



BEDFORD

Product ID	W	H	D
BKTM02X12X15TBE	2"	15"	12"

Triple Center Brace

IRON BRACKETS



YORK

Product ID

BKTM01X12X15SYO

Single Center Brace

W	H	D
1 1/2"	15"	12"



YORK

Product ID

BKTM02X07X10TYO

Triple Center Brace

W	H	D
2"	10"	7 1/2"



YORK

Product ID

BKTM01X07X10SYO

Single Center Brace

W	H	D
1 1/2"	10"	7 1/2"



YORK

Product ID

BKTM02X10X12TYO

Triple Center Brace

W	H	D
2"	12"	10"



YORK

Product ID

BKTM01X10X12SYO

Single Center Brace

W	H	D
1 1/2"	12"	10"



YORK

Product ID

BKTM02X12X15TYO

Triple Center Brace

W	H	D
2"	15"	12"

FINISHES

1.



2.



3.



4.





5.



6.



7.

- 1. BRASS**
- 2. BRONZE**
- 3. COPPER**
- 5. PALE GOLD**
- 4. PEWTER**
- 6. SILVER**
- 7. WARM SILVER**

ADHESIVES & CAULK



Loctite PL Premium 3x



Product ID

1390595

Description

Polyurethane Construction Adhesive - Tan

Volume

10 fl. oz.

Application: most common construction materials

Loctite PL Premium 8x



Product ID

1417170

Description

Advanced Polyurethane Construction Adhesive - Tan

Volume

10 fl. oz.

Application: most common construction materials

Loctite Polyseamseal



1507600

Description

Acrylic Caulk With Silicone - White

Volume

Product ID

10 fl. oz.

Application: wood, drywall, plaster, metals, brick, concrete, masonry, & painted surfaces

Loctite Polyseamseal



Product ID

1507593

Description

Acrylic Caulk With Silicone - Clear

Volume

10 fl. oz.

Application: wood, drywall, plaster, metals, brick, concrete, masonry, & painted surfaces



LoctiteExpress

Product ID
1684603

Description

Painters Express - White

Volume

10 fl. oz.

Application: wood, molding, wainscoting, plaster, drywall, door & window frames, ceramic tiles, brick, concrete and metal.



Loctite Polyseamseal

Product ID
1511100

Description

Painters Caulk - White

Volume

10 fl. oz.

Application: wood, molding, wainscoting, plaster, drywall, door & window frames, ceramic tiles, brick, concrete and metal.



Loctite Power Grab

Product ID
1589158

Description

Molding and Paneling Adhesive - Clear

Volume

9 fl. oz.

Application: Bonding paneling, drywall, molding, corkboard, ridged PVC and hardboard to wood, stainless steel, glass, cork, foamboard, ceramics, plaster, stone, brick, concrete, chip board and PVC (rigid plastic)

LOCTITE®

INDEX

A

APL11X02X01SC	338
APL11X06X01SH	338
APL16X08X01SH	342
APL23X05X01SC	344
APL28X09X02SC	345
APL28X15X02SH	345
APL36X09X01SC	346
APL42X21X03AN	347

B

BAL02X24ST	33
BAL02X28ST	33
BAL02X32ST	33
BAL02X36ST	33
BAL04X19TR	33
BAL04X23TR	33
BAL04X27TR	33
BAL05X18AC-N	32
BAL05X18AV-N	25
BAL05X18BR-N	26
BAL05X18EM-N	27
BAL05X18HM-N	28
BAL05X18LG-N	29
BAL05X18WE-N	30
BAL05X18YO-N	31
BAL05X21AC-L	32
BAL05X21AV-L	25
BAL05X21AV-M	25
BAL05X21BR-L	26
BAL05X21BR-M	26
BAL05X21EM-L	27
BAL05X21EM-M	27
BAL05X21HM-L	28
BAL05X21HM-M	28
BAL05X21LG-L	29
BAL05X21LG-M	29
BAL05X21WE-L	30
BAL05X21WE-M	30
BAL05X21YO-L	31
BAL05X21YO-M	31
BAL05X23AC-J	32
BAL05X23AV-J	25

BAL05X23AV-K	25
BAL05X23BR-J	26
BAL05X23BR-K	26
BAL05X23EM-J	27
BAL05X23EM-K	27
BAL05X23HM-J	28
BAL05X23HM-K	28
BAL05X23LG-J	29
BAL05X23LG-K	29
BAL05X23WE-J	30
BAL05X23WE-K	30
BAL05X23YO-J	31
BAL05X23YO-K	31
BAL05X24AC-G	32
BAL05X24AV-G	25
BAL05X24AV-H	25
BAL05X24AV-I	25
BAL05X24BR-G	26
BAL05X24BR-H	26
BAL05X24BR-I	26
BAL05X24EM-G	27
BAL05X24EM-H	27
BAL05X24EM-I	27
BAL05X24HM-G	28
BAL05X24HM-H	28
BAL05X24HM-I	28
BAL05X24LG-G	29
BAL05X24LG-H	29
BAL05X24LG-I	29
BAL05X24OX	33
BAL05X24WE-G	30
BAL05X24WE-H	30
BAL05X24WE-I	30
BAL05X24YO-G	31
BAL05X24YO-H	31
BAL05X24YO-I	31
BAL05X26AC-D	32
BAL05X26AV-D	25
BAL05X26AV-E	25
BAL05X26AV-F	25
BAL05X26BR-D	26
BAL05X26BR-E	26
BAL05X26BR-F	26
BAL05X26EM-D	27
BAL05X26EM-E	27
BAL05X26EM-F	27
BAL05X26HM-D	28
BAL05X26HM-E	28

BAL05X26HM-F	28
BAL05X26LG-D	29
BAL05X26LG-E	29
BAL05X26LG-F	29
BAL05X26WE-D	30
BAL05X26WE-E	30
BAL05X26WE-F	30
BAL05X26YO-D	31
BAL05X26YO-E	31
BAL05X26YO-F	31
BAL05X28AC-A	32
BAL05X28AV-A	25
BAL05X28AV-B	25
BAL05X28AV-C	25
BAL05X28BR-A	26
BAL05X28BR-B	26
BAL05X28BR-C	26
BAL05X28EM-A	27
BAL05X28EM-B	27
BAL05X28EM-C	27
BAL05X28HM-A	28
BAL05X28HM-B	28
BAL05X28HM-C	28
BAL05X28LG-A	29
BAL05X28LG-B	29
BAL05X28LG-C	29
BAL05X28OX	33
BAL05X28WE-A	30
BAL05X28WE-B	30
BAL05X28WE-C	30
BAL05X28YO-A	31
BAL05X28YO-B	31
BAL05X28YO-C	31
BAS10X17X02CL	81
BAS14X24X02CL	81
BBD03X00AB	248
BBD03X00AS	248
BBD03X00BA	248
BBD03X00HO	248
BBD04X00BA	248
BBD04X00BR	249
BBD04X00SU	248
BBD04X01OS	249
BBD05X00AB	249
BBD05X00BR	249
BBD06X01OS	249
BKTBE2	406
BKTBE4	406

BKTBE6 406
BR07X 35

C

CAP06X05X02RC 74
CAP07X01X07AR 76
CAP08X02X05OD 75
CAP08X05X02AC 75
CAP08X05X02CH 74
CAP08X07X02CL 76
CAP08X07X02TR 75
CAP08X07X03RC 75
CAP09X03X02SO 76
CAP10X03X02SO 76
CAP10X06X03AC 76
CAP11X07X11AT 78
CAP11X08X03TW 77
CAP12X06X03AC 77
CAP13X09X06CL 76
CAP16X10X04EM 77
CAP17X11X05AC 78
CAP19X06X14KD 78
CAP19X13X05EM 79
CAP21X07X16SU 79
CAP24X15X06AC 79
CAP24X17X06VI 79
CAP25X25X08RC 79
CAS02X00AL 221
CAS02X00BE 225
CAS02X00MO 246
CAS03X01DE 246
CAS03X01DR 232
CAS03X01DU 233
CAS04X00EL 237
CAS04X00FE 246
CAS04X01DY 234
CAS04X94X01 73, 233
CAS05X01MI 246
CAS05X79X01 73, 246
CAS07X79X01 73, 247
CAS08X94X01 73, 247
CAS10X79X01 73, 247
CAS13X79X01 73, 247
CAS15X79X02 73, 247
CAS18X94X02 73, 247
CHA01X00CO 221

CHA01X00EM 217
CHA01X00FE 219
CHA01X00SO 220
CHA01X00ST 217
CHA01X00SW 219
CHA02X00CR 226
CHA02X00ED 225
CHA02X00LI 246
CHA02X00TR 226
CHA02X01CI 224
CHA02X01QU 221
CHA03X00AT 231
CHA03X00CA 228
CHA03X00DI 232
CHA03X00DL 230
CHA03X00FE 228
CHA03X00MA 233
CHA03X00ME 231
CHA03X00NE 227
CHA03X00RO 233
CHA03X00WI 229
CHA03X01ER 228
CHA03X01FE 229
CHA03X01LE 228
CHA03X01LI 233
CHA03X01LY 227
CHA03X01NE 233
CHA03X01RO 230
CHA03X02FE 229
CHA04X00FL 236
CHA04X00LI 237
CHA04X00NS 235
CHA04X00SH 237
CHA04X01CL 235
CHA04X01DY 234
CHA04X01FE 236
CHA04X01RO 235
CHA04X01SQ 235
CHA04X01TN 236
CHA04X01VE 234
CHA05X01AN 238
CHA05X01CH 239
CHA05X02HO 236
CHA06X00SP 240
CHA06X01OD 240
CHA07X01ER 242
CHA07X01HA 242
CHA07X01UR 242

CM07AL 257
CM07EM 257
CM07OD 257
CM07OL 257
CM08AD 257
CM08DN 257
CM09BN 257
CM09CL 258
CM09MA 258
CM10AD 258
CM10CL 258
CM10DN 258
CM11BL 259
CM11BN 258
CM11HE 259
CM11LF 258
CM11LI 258
CM11PA 258
CM11PM 258
CM11WA 258
CM12AD 259
CM12BR 261
CM12CA 261
CM12DN 259
CM12FE 261
CM12FL 260
CM12LE 261
CM12ME 260
CM12NA 259
CM12PM 259
CM12RE 259
CM12RI 260
CM12TR 259
CM12VA 259
CM13AS 262
CM13BL 261
CM13BN 261
CM13BR 261
CM13MO 262
CM13OR 261
CM13SA 261
CM13TI 262
CM14AX 262
CM14KT 262
CM14NE 262
CM14TR 262
CM15AR 263
CM15BA 262

INDEX

CM15BE	263	CM18GA	270	CM21X30AL	282
CM15CH	263	CM18KA	269	CM21YO	273
CM15CN	262	CM18KD	269	CM22AT	273
CM15DE	263	CM18KE	267	CM22BO	274
CM15DU	262	CM18NI	268	CM22CN	273
CM15FE	262	CM18NO	268	CM22GR	274
CM15FO	263	CM18NT	268	CM22LN	271
CM15GA	263	CM18OL	268	CM22OR	273
CM15LI	262	CM18OL1	268	CM22RB	273
CM16AD	264	CM18PO	270	CM22TN	273
CM16AP	265	CM18RA	269	CM23AC	275
CM16ER	266	CM18RA2	268	CM23AS	275
CM16GN	264	CM18RI	268	CM23BE	275
CM16MD	265	CM18RL	268	CM23BI	274
CM16ME	265	CM18RO	269	CM23BO	275
CM16ML	264	CM18SA	270	CM23FL	274
CM16OX	266	CM18SE	268	CM23GA	274
CM16PL	265	CM18SK	269	CM23JA	275
CM16SO	265	CM18VL	269	CM23KA	275
CM16SW	266	CM18WA	268	CM23LU	275
CM16TY	265	CM19CA	270	CM23LY	274
CM16WG	265	CM19FO	270	CM23MO	274
CM16WR	265	CM19GA	270	CM23PM	275
CM17CA	266	CM19OR	270	CM23RO	275
CM17DU	267	CM19SP	270	CM23RO1	274
CM17EX	267	CM19TG	265	CM23VA	274
CM17FE	266	CM20AL	271	CM24CA	276
CM17HA	266	CM20AN	272	CM24CR	276
CM17LE	267	CM20BE	272	CM24DI	275
CM17MU	266	CM20BE1	271	CM24EN	277
CM17OL	266	CM20BL	271	CM24GA	274
CM17PE	267	CM20BO	271	CM24LA	278
CM17PR	266	CM20BX	273	CM24LO	275
CM17RA2	266	CM20DA	271	CM24LO1	276
CM17RO	267	CM20DR	271	CM24NA	276
CM17SO	265	CM20FO	271	CM24RE	276
CM17TE	267	CM20HA	271	CM24SH	276
CM17TS	267	CM20HO	272	CM24SW	275
CM17WA	266	CM20JA	271	CM24TE	276
CM18AL	270	CM20LN	272	CM24TH	276
CM18BI	267	CM20LU	271	CM24TR	276
CM18BR	269	CM20PM	272	CM24WA	276
CM18CR	267	CM20VI	271	CM24X12MA	278
CM18DI	268	CM21LU	273	CM25BR	278
CM18ED	267	CM21MA	273	CM25CO	278
CM18ED1	269	CM21RE	273	CM25FE	278
CM18ER	267	CM21WA	273	CM25NE	278
CM18FW2	270	CM21WR	273	CM25SP	278

CM25X18SK	278	CM31PM	283	CMW24TR	427
CM26AT	279	CM31TR	283	COR04X05X10SC	316
CM26CS	279	CM32AN	283	COR04X06X03TR	317
CM26EL	279	CM32BR	283	COR04X06X03WA	317
CM26HU	279	CM32DE	283	COR04X07X03RE	316
CM26JE	279	CM32GI	283	COR04X07X14RE	317
CM26LF	279	CM32JA	283	COR05X02X05DU	317
CM26LO	279	CM32TN	283	COR05X02X07HI	319
CM26MR	279	CM33DA	284	COR05X02X07SA	318
CM26PE	279	CM33RO	284	COR05X02X08EM	319
CM26TA	278	CM33SC	284	COR05X02X08RO	318
CM26TN	278	CM33VE	284	COR05X02X09CO	318
CM26VI	278	CM35VI	284	COR05X02X09MO	319
CM27AR	280	CM35X22AN	284	COR05X03X06NI	318
CM27AT	279	CM36GL	284	COR05X03X08AT	319
CM27BR	279	CM36JU	284	COR05X03X08ED	319
CM27HE	280	CM37NA	284	COR05X03X09BR	319
CM27SY	280	CM38OL	285	COR05X04X09AD	319
CM27TO	280	CM38OS	285	COR05X04X12OD	320
CM27WI	280	CM39AT	286	COR05X04X15AC	319
CM28BE	281	CM40CL	286	COR05X04X17ST	320
CM28NI	281	CM40DL	286	COR05X05X09DE	319
CM28OS	280	CM40MI	286	COR05X05X12DA	319
CM28ST	280	CM41FL	286	COR05X06X14SA	319
CM29AT	281	CM41NE	286	COR05X10X05AC	319
CM29CA	281	CM42SK	286	COR06X02X08LF	320
CM29DA	281	CM42SP	286	COR06X03X07OL	320
CM29FA	282	CM42X28AS	286	COR06X03X09LN	320
CM29FW	281	CM47MI	287	COR06X03X10ME	320
CM29HY	281	CM50LO	287	COR06X03X10RO	320
CM29OA	281	CM51GL	287	COR06X03X11AR	321
CM29SF	281	CM51NE	287	COR06X04X03FO	317
CM29SP	281	CM53AT	287	COR06X04X09CH	320
CM29WG	282	CM54MI	287	COR06X04X10OA	321
CM30AT	282	CM54TCL	287	COR06X04X14JA	320
CM30DY	282	CM67PE	287	COR06X05X09QU	320
CM30FL	282	CM70X43ML	287	COR06X05X10HO	321
CM30KI	282	CMW16AC	426	COR06X07X13DE	320
CM30KT	274	CMW16BE	427	COR06X13X03GR	321
CM30NE	282	CMW16FL	427	COR06X18X04HA	320
CM30RO	282	CMW16TR	427	COR07X03X08PO	322
CM30SG	282	CMW20AC	426	COR07X03X09FL	321
CM30SP	281	CMW20BE	427	COR07X03X09SP	321
CM30TE	282	CMW20FL	427	COR07X03X10NA	322
CM31BA	283	CMW20TR	427	COR07X05X11WA	322
CM31DU	282	CMW24AC	426	COR07X05X13BE	322
CM31GO	283	CMW24BE	427	COR07X06X14DE	322
CM31KI	283	CMW24FL	427	COR07X07X05TR	322

INDEX

COR07X08X18SC	323	R39SU	296	CT24X24KI	303
COR08X04X11FO	324	CR41FL	296	CT24X24RO	303
COR08X04X12WI	323	CR41HI	296	CT24X24ST	303
COR08X05X11RO	324	CR41RO	296	CT28X28AS	280
COR08X05X14AC	323	CR41TR	296		
COR08X06X11NE	322	CR43EL	297		
COR08X06X13LF	324	CR44BE	297		
COR08X06X23AC	323	CR44WA	297		
COR08X06X28FA	325	CR47DT	297		
COR09X03X15LI	324	CR47MO	297		
COR09X07X11MD	324	CR49SU	297		
COR09X17X05AL	324	CR49TO	297		
COR09X20X06MA	324	CR50DU	297		
COR10X05X37MO	325	CR51MA	298		
COR10X11X25SC	324	CR52OX	298		
COR11X05X13AN	324	CR55FX	299		
COR11X05X14LY	324	CR55MI	298		
COR11X05X40AN-L	325	CR55SQ	299		
COR11X05X40AN-R	325	CR57SE	299		
COR11X08X20SG	324	CR57TI	299		
COR12X02X07GE	308	CR59AR	299		
COR12X04X02LE	317	CR59DY	299		
COR14X08X05AC	324	CR59FL	298		
CR07WG	295	CR59PO	299		
CR09SW	295	CR59TE	299		
CR13KE	295	CR63ED	299		
CR15ME	295	CR63HI	299		
CR20EG	297	CR64CA	300		
CR21EG	295	CR64TR	300		
CR22MD	295	CR65HI	300		
CR22RA	295	CR67BR	300		
CR23CL	295	CR67FE	299		
CR23EG	295	CR67SO	300		
CR25FL	298	CR69CH	300		
CR25KE	298	CCR70BE	300		
CR25ME	297	CR70CA	300		
CR28OR	295	CR70PM	300		
CR29MO	295	CR73ME	301		
CR32RO	300	CR78MI	301		
CR34MD	295	CR78SH	301		
CR35PI	296	CR78SP	301		
CR35WA	296	CR86LE	301		
CR37FL	301	CR96TR	301		
CR38OX	296	CRH09X44FE	68		
CR39DE	296	CRH09X54SE	68		
CR39KE	297	CRH09X68SE	68		
CR39NE	296	CT24X24CO	303		
CR39SI	296	CT24X24EG	303		

D

DOME26DU	290
DOME28AS	293
DOME28TR	290
DOME31MI	290
DOME32NE	290
DOME32TR	291
DOME34BE	293
DOME35CH	290
DOME35DE	291
DOME37TR	293
DOME38AR	291
DOME38OD	291
DOME39HI	291
DOME39MI	291
DOME42HA	291
DOME44ED	291
DOME44SM	291
DOME46BE	291
DOME47AN	292
DOME47CL	291
DOME47DE	292
DOME47MI	292
DOME47SA	292
DOME47ST	292
DOME50AR	292
DOME51DU	292
DOME51HI	292
DOME53BE	292
DOME57VA	292
DOME59DU	293
DOME59FL	292
DOME59SU	293
DOME60CL	293
DOME62AR	293
DOME74AR	293
DOME79HI	293
DOME87AR	293

E

EL0806ENPTUTU	34
EL0808ENPTUTU	34
EL0809ENPTUTU	34
EL0810ENPTUTU	34
EL1006ENPTUTU	34
EL1008ENPTUTU	34
EL1009ENPTUTU	34
EL1010ENPTUTU	34
EL1206ENPTUTU	34
EL1208ENPTUTU	34
EL1209ENPTUTU	34
EL1210ENPTUTU	34

F

FIN03X04TR	35
FIN04X07BL	35
FIN04X08AB	35
FIN04X09SO	35
FIN04X11UR	35
FIN06X13UR	35
FLT03X01X96	246
FLT07X00TR	247
FLT07X01X0FL	247
FTBRACKETS	35

G

GVCA16X36-34	87
GVCA18X30*	87
GVCA18X30-22	87
GVCA18X30-24	87
GVCA18X30-26	87
GVCA18X30-28	87
GVCA22X32*	87
GVCA22X32-24	87
GVCA22X32-26	87
GVCA22X32-28	87
GVCA22X32-30	87
GVDI34X34*	89
GVEY12X24*	85

GVEY12X24-16	85
GVEY12X24-18	85
GVEY12X24-20	85
GVEY12X24-22	85
GVEY18X30*	85
GVEY18X30-16	85
GVEY18X30-18	85
GVEY18X30-20	85
GVEY18X30-22	85
GVEY18X30-24	85
GVEY18X30-26	85
GVEY18X30-28	85
GVHR24	88
GVHR28	88
GVHR32	88
GVHR36	88
GVHR40	88
GVHR48	88
GVHR60	88
GVOC18X18	89
GVOC22X22	89
GVOC30X30	89
GVOV25X37*	89
GVOV29X20	88
GVOVT32X44	89
GVPE12X32*	85
GVPE12X32-18	85
GVPE12X32-20	85
GVPE12X32-22	85
GVPE12X32-24	85
GVPE12X32-26	85
GVPE12X32-28	85
GVPE12X32-30	85
GVPE24X30*	85
GVPE24X30-18	85
GVPE24X30-20	85
GVPE24X30-22	85
GVPE24X30-24	85
GVPE24X30-26	85
GVPE24X30-28	85
GVPE24X36*	85
GVPE24X36-32	85
GVPE24X36-34	85
GVPE24X54*	85
GVPE24X54-38	85
GVPE24X54-40	85
GVPE24X54-42	85
GVPE24X54-44	85

GVPE24X54-46	85
GVPE24X54-48	85
GVPE24X54-50	85
GVPE24X54-52	85
GVRO12	88
GVRO16	88
GVRO18	88
GVRO20	88
GVRO22	88
GVRO22*K	88
GVRO23	88
GVRO24	88
GVRO24*K	88
GVRO24T*K	88
GVRO27	88
GVRO28	88
GVRO30	88
GVRO30T*K	88
GVRO36	88
GVRO36T*K	88
GVROT18	89
GVROT24	89
GVROT28	89
GVTR48X20	89
GVTR48X24	89
GVTR65X21	89
GVTR65X27	89
GVTR65X32	89
GVTR72X18	89
GVTR72X21	89
GVVE12X18*	86
GVVE12X18-12	86
GVVE12X18-14	86
GVVE12X18-16	86
GVVE12X24*	86
GVVE12X24-20	86
GVVE12X24-22	86
GVVE12X36*	86
GVVE12X36-26	86
GVVE12X36-28	86
GVVE12X36-30	86
GVVE12X36-32	86
GVVE12X36-34	86
GVVE15X15*	86
GVVE15X15-12	86
GVVE15X15-14	86
GVVE15X30*	86
GVVE15X30-16	86

GVVE15X30-18	86
GVVE15X30-20	86
GVVE15X30-22	86
GVVE15X30-24	86
GVVE15X30-26	86
GVVE15X30-28	86
GVVE16X24*	86
GVVE16X24-12	86
GVVE16X24-14	86
GVVE16X24-16	86
GVVE16X24-18	86
GVVE16X24-20	86
GVVE16X24-22	86
GVVE16X36*	86
GVVE16X36-26	86
GVVE16X36-28	86
GVVE16X36-30	86
GVVE16X36-32	86
GVVE16X36-34	86
GVVE18X24*	86
GVVE18X24-12	86
GVVE18X24-14	86
GVVE18X24-16	86
GVVE18X24-18	86
GVVE18X24-20	86
GVVE18X24-22	86
GVVE18X30*	86
GVVE18X30-26	86
GVVE18X30-28	86
GVVE18X36*	86
GVVE18X36-32	86
GVVE18X36-34	86
GVVE24X36*	86
GVVE24X36-12	86
GVVE24X36-14	86
GVVE24X36-16	86
GVVE24X36-18	86
GVVE24X36-20	86
GVVE24X36-22	86
GVVE24X36-24	86
GVVE24X36-26	86
GVVE24X36-28	86
GVVE24X36-30	86
GVVE24X36-32	86
GVVE24X36-34	86

K

KEY05X06X04TR	69
KEY05X07X04AM	69
KEY05X08X04BA	69
KEY05X08X04ST	69
KEY06X07X04NE	69
KEY06X07X04RI	69
KEY08X11X06ED	69
KEY08X11X06EL	69
KEY08X13X08AS	69
KEY08X14X08CH	69

M

MDB03X03	197
MDB03X03BI	196
MDB04X04	198
MDB04X04BX	197
MDB05X06BI	196
MIC01X01OD	153
MIC01X02VA	153
MIC01X03BE	152
MIC02X02CR	149
MIC02X02DE	151
MIC02X02DU	151
MIC02X02EG	153
MIC02X02HE	198
MIC02X02LY	153
MIC02X02SH	150
MIC02X02SQ	151
MIC02X03GO	150
MIC02X03LI	199
MIC02X05RO	141
MIC03X02EG	149
MIC03X03	197
MIC03X03AT	145
MIC03X03BE	198
MIC03X03BI	196
MIC03X03BU	145
MIC03X03CH	198
MIC03X03DE	147
MIC03X03DU	145
MIC03X03ED	199
MIC03X03HI	199

MIC03X03HO	147
MIC03X03LE	147
MIC03X03PA	150
MIC03X03SA	148
MIC03X03ST	146
MIC03X04DE	144
MIC03X04ED	146
MIC04X03BU	144
MIC04X03DY	145
MIC04X03ME	199
MIC04X03MO	199
MIC04X03TR	161
MIC04X04	198
MIC04X04BX	197
MIC04X04DE	142
MIC04X04DY	199
MIC04X04FO	199
MIC05X04ED	142
MIC05X05AT	140
MIC05X05SM	199
MIC05X06BI	196
MIC05X06TI	139
MIC07X05NI	139
MIC07X06FO	138
MIC09X06	197
MLD01X00AC	219
MLD01X00AL	217
MLD01X00BL	221
MLD01X00BU	202,218
MLD01X00CR	218
MLD01X00VA	218
MLD01X00VI	219
MLD01X01EG	218
MLD01X01X01HI	195
MLD01X01X02AS	195
MLD01X01X02BE	195
MLD01X01X02CL	194
MLD01X01X02ED	195
MLD01X01X02JA	195
MLD01X01X02OD	153
MLD01X01X02TR	194
MLD01X01X02TY	195
MLD01X02X02ED	194
MLD01X04X04AD	181
MLD02X00AL	224
MLD02X00BE	225
MLD02X00BU	225
MLD02X00ER	226

MLD02X00KE	223	MLD02X02X04CR	149	MLD03X03X03OR	189
MLD02X00MA	223	MLD02X02X04EG	184	MLD03X03X04BD	179
MLD02X00NO	226	MLD02X02X04ML	186	MLD03X03X04BE	182
MLD02X00SA	224	MLD02X02X04QU	184	MLD03X03X04CE	180
MLD02X00TI	226	MLD02X02X04TN	185	MLD03X03X04CL	186
MLD02X01BE	225	MLD02X02X06LN	191	MLD03X03X04CN	179
MLD02X01BQ	222	MLD02X03X04EG	149	MLD03X03X04CO	182
MLD02X01ED	226	MLD02X03X04EM	187	MLD03X03X04DE	147
MLD02X01LE	222	MLD02X03X04NE	183	MLD03X03X04DT	183
MLD02X01SW	225	MLD02X03X04VA	180	MLD03X03X04FE	180
MLD02X01X02AS	193	MLD02X05X05FO	170	MLD03X03X04FO	184
MLD02X01X02RE	194	MLD03X00CO	230	MLD03X03X04GV	147
MLD02X01X02VA	153	MLD03X00DI	227	MLD03X03X04HO	177
MLD02X01X03AS	190	MLD03X00EM	229	MLD03X03X04JA	184
MLD02X01X03CL	191	MLD03X00ER	231	MLD03X03X04KD	182
MLD02X01X03DE	191	MLD03X00MA	229	MLD03X03X04LE	147
MLD02X01X03LE	192	MLD03X01BE	232	MLD03X03X04LO	187
MLD02X01X03PI	191	MLD03X01DU	227	MLD03X03X04ME	180
MLD02X02X01AR	188	MLD03X01MU	232	MLD03X03X04PA	150
MLD02X02X02DE	192	MLD03X01OD	232	MLD03X03X04QU	177
MLD02X02X02GI	194	MLD03X01WF	228	MLD03X03X04RE	180
MLD02X02X02KE	194	MLD03X01X03BE	152	MLD03X03X04RO	181
MLD02X02X02MA	193	MLD03X01X03BR	189	MLD03X03X04SA	148
MLD02X02X02MD	194	MLD03X01X03DE	191	MLD03X03X04SO	180
MLD02X02X02SH	150	MLD03X01X03EG	153	MLD03X03X04TR	178
MLD02X02X03AC	431	MLD03X01X04SQ	185	MLD03X03X04VA	186
MLD02X02X03AD	431	MLD03X02X03BE	431	MLD03X03X04VI	179
MLD02X02X03AT	188	MLD03X02X03DE	189	MLD03X03X05AC	431
MLD02X02X03BA	187	MLD03X02X03ED	192	MLD03X03X05AD	431
MLD02X02X03BL	192	MLD03X02X03FL	188	MLD03X03X05AT	145
MLD02X02X03DE	151	MLD03X02X03HE	187	MLD03X03X05BU	145
MLD02X02X03DU	151	MLD03X02X03LI	189	MLD03X03X05DU	145
MLD02X02X03ED	190	MLD03X02X03LO	192	MLD03X03X05FL	179
MLD02X02X03EG	192	MLD03X02X03TR	189	MLD03X03X05FO	172
MLD02X02X03ER	192	MLD03X02X04AL	182	MLD03X03X05GO	172
MLD02X02X03FE	189	MLD03X02X04BU	186	MLD03X03X05LA	432
MLD02X02X03HA	193	MLD03X02X04DA	184	MLD03X03X05LI	173
MLD02X02X03JE	191	MLD03X02X04ER	183	MLD03X03X05ME	432
MLD02X02X03LA	432	MLD03X02X04FO	189	MLD03X03X05NO	175
MLD02X02X03LO	190	MLD03X02X04GO	150	MLD03X03X05PE	180
MLD02X02X03LY	153	MLD03X02X04HA	181	MLD03X03X05SG	174
MLD02X02X03ME	432	MLD03X02X04LA	184	MLD03X03X05ST	146
MLD02X02X03NE	191	MLD03X02X04MA	188	MLD03X03X05SU	176
MLD02X02X03OR	187	MLD03X02X04ME	185	MLD03X03X05TH	175
MLD02X02X03QU	186	MLD03X02X04RO	183	MLD03X03X06AS	176
MLD02X02X03SQ	151	MLD03X02X04TE	186	MLD03X04X05BU	144
MLD02X02X03TR	189	MLD03X02X04TR	182	MLD03X04X05DE	144
MLD02X02X04CL	190	MLD03X02X04VA	186	MLD03X04X05DY	145

INDEX

MLD03X04X05LI	177	MLD04X04X06BR	166	MLD05X04X06HA	170
MLD03X04X05MA	172	MLD04X04X06CL	167	MLD05X04X06SA	164
MLD03X04X05TR	161	MLD04X04X06CT	167	MLD05X04X07FE	162
MLD03X04X05WI	172	MLD04X04X06DE	166	MLD05X04X07NS	161
MLD03X04X06PA	168	MLD04X04X06EM	166	MLD05X05X06BR	165
MLD04X00FT	246	MLD04X04X06ER	168	MLD05X05X07AR	161
MLD04X00OS	234	MLD04X04X06HE	167	MLD05X05X07AT	140
MLD04X01DE	236	MLD04X04X06JO	166	MLD05X05X07DE	163
MLD04X01DU	235	MLD04X04X06KD	171	MLD05X05X07FE	163
MLD04X01SE	237	MLD04X04X06LA	432	MLD05X05X07FL	161
MLD04X01SY	234	MLD04X04X06LI	170	MLD05X05X07HE	164
MLD04X02X04FL	184	MLD04X04X06ME	432	MLD05X05X07TS	162
MLD04X02X04HE	183	MLD04X04X06SG	165	MLD05X05X07WA	163
MLD04X02X04HO	181	MLD04X04X06TN	165	MLD05X06X06FE	165
MLD04X02X04RB	177	MLD04X05X06AC	431	MLD05X06X08MO	160
MLD04X02X04SQ	181	MLD04X05X06AR	164	MLD05X06X08VE	160
MLD04X02X05AS	172	MLD04X05X06ED	142	MLD05X07X09NI	139
MLD04X02X05BE	432	MLD04X05X06WA	168	MLD06X01FL	239
MLD04X02X05ED	146	MLD04X05X07CO	165	MLD06X02FE	240
MLD04X02X05EG	175	MLD04X05X07NA	164	MLD06X02X07FL	164
MLD04X02X05ML	176	MLD04X07X08PE	160	MLD06X02X07GE	163
MLD04X02X05TE	176	MLD04X09X10AN	157	MLD06X02X07KI	164
MLD04X02X05VE	175	MLD05X00AB	237	MLD06X03ST	238
MLD04X02X05VI	179	MLD05X00OL	238	MLD06X03X06LO	166
MLD04X03X05DE	171	MLD05X00VE	238	MLD06X03X07EG	165
MLD04X03X05ED	181	MLD05X00WA	237	MLD06X04ST-1	240
MLD04X03X05EL	170	MLD05X01BE	238	MLD06X04ST-2	238
MLD04X03X05EM	175	MLD05X01BO	237	MLD06X04X07AX	160
MLD04X03X05GR	175	MLD05X01DU	238	MLD06X04X07DI	163
MLD04X03X05HE	174	MLD05X01EM	238	MLD06X04X07HA	162
MLD04X03X05JA	177	MLD05X02X05AN	174	MLD06X05X08BE	160
MLD04X03X05NE	176	MLD05X02X05DC	174	MLD06X05X08CL	159
MLD04X03X05TR	176	MLD05X02X05VE	171	MLD06X05X08FA	159
MLD04X03X05VI	173	MLD05X02X06BE	169	MLD06X05X08TI	139
MLD04X03X06BE	142	MLD05X02X06FL	167	MLD06X06X08BR	160
MLD04X03X06CO	168	MLD05X02X06KE	166	MLD06X06X08SY	159
MLD04X03X06DE	171	MLD05X02X06RI	169	MLD06X06X09HM	159
MLD04X03X06DU	168	MLD05X02X06RO	141	MLD06X06X09ST	158
MLD04X04X04DU	170	MLD05X02X06SP	168	MLD06X07X09FO	138
MLD04X04X05BA	169	MLD05X02X08SE	239	MLD06X08X10FL	157
MLD04X04X05BQ	174	MLD05X03X05DE	171	MLD07X01AS	241
MLD04X04X05BU	175	MLD05X03X05NA	173	MLD07X01AX	242
MLD04X04X05EG	173	MLD05X03X06AR	170	MLD07X01BR	242
MLD04X04X05ER	174	MLD05X03X06NI	168	MLD07X01EL	241
MLD04X04X05GR	171	MLD05X03X06SC	166	MLD07X01EM	242
MLD04X04X05KE	173	MLD05X03X06TR	165	MLD07X01MO	241
MLD04X04X05RO	173	MLD05X04ST	237	MLD07X01TE	243
MLD04X04X06AD	431	MLD05X04X06BE	431	MLD07X01TY	241

MLD07X01WE	241	MOC03X03DU	145	NCH27X45WA	372
MLD07X02X07VL	163	MOC03X03HO	177	NCH30X42HI	372
MLD07X03X08FL	160	MOC03X03LE	147	NCH30X42WA	372
MLD07X03X08MI	160	MOC03X03PA	150	NCH30X50BE	371
MLD07X05X08ZE	159	MOC03X03SA	148	NCH30X50ER	373
MLD07X05X09OD	158	MOC03X03ST	146	NCH35X65BE	371
MLD07X06X09AR	158	MOC03X04DE	144	NCH37X17ED	373
MLD07X06X09JO	159	MOC03X04ED	146	NCH42X07BE	373
MLD07X07X10BE	157	MOC04X03BU	144	NPB08X08	35
MLD07X09X11OD	156	MOC04X03DY	145	NPB10X10	35
MLD08X03X09BE	158	MOC04X03TR	161	NPB12X12	35
MLD08X06X10FO	157	MOC04X04	197	NPC08X08F	35
MLD08X07X11MD	156	MOC04X04BX	197	NPC08X08P	35
MLD08X08X11AC	156	MOC04X04DE	142	NPC10X10F	35
MLD08X08X12ME	156	MOC05X04ED	142	NPC10X10P	35
MLD08X09X12RO	156	MOC05X05AT	140	NPC12X12F	35
MLD09X03X09SO	157	MOC05X06BI	196	NPC12X12P	35
MLD09X03X09WF	157	MOC05X06TI	139	NWL08X40CP	34
MLD09X03X10AL	158	MOC07X05NI	139	NWL08X40EP	34
MLD09X09X14GR	155	MOC07X06FO	138	NWL08X40PL	34
MLD09X10X14HI	155	MOC09X06	197	NWL08X40SP	34
MLD09X12X14CL	155			NWL08X48CP	34
MLD10X12X16MI	155	N		NWL08X48EP	34
MLD11X02BE	243	NCH11X20MA	371	NWL08X48PL	34
MLD11X04X12CH	156	NCH14X06CR	373	NWL08X48SP	34
MLD11X08X13SP	155	NCH15X31SM	372	NWL10X40CP	34
MLD12X07X14FA	155	NCH16X27TR	370	NWL10X40EP	34
MLD13X07X12ER	156	NCH16X29AD	372	NWL10X40PL	34
MOC01X01OD	153	NCH16X30AL	370	NWL10X40SP	34
MOC01X02VA	153	NCH16X38ME	373	NWL10X48CP	34
MOC01X03BE	152	NCH17X05FE	373	NWL10X48EP	34
MOC02X02CR	149	NCH17X30KE	370	NWL10X48PL	34
MOC02X02DE	151	NCH17X31AS	370	NWL10X48SP	34
MOC02X02DU	151	NCH18X38ME	370	NWL12X40CP	34
MOC02X02EG	153	NCH19X37SH	372	NWL12X40EP	34
MOC02X02LY	153	NCH21X33WA	372	NWL12X40PL	34
MOC02X02SH	150	NCH21X39AD	371	NWL12X40SP	34
MOC02X02SQ	151	NCH23X43ML	371	NWL12X48CP	34
MOC02X03GO	150	NCH24X49CL	371	NWL12X48EP	34
MOC02X05RO	141	NCH24X49RE	373	NWL12X48PL	34
MOC03X02EG	149	NCH25X51AT	371	NWL12X48SP	34
MOC03X03	196	NCH26X09DE	373		
MOC03X03AT	145	NCH27X05DE	373	O	
MOC03X03BE	198	NCH27X38OD	371	ONL01X03LE	327
MOC03X03BI	196	NCH27X42EG	372	ONL02X02AT	327
MOC03X03BU	145	NCH27X45ED	371		
MOC03X03CH	198	NCH27X45HI	372		
MOC03X03DE	147				

INDEX

ONL02X02SW	327	ONL04X07X01ZE-R	349	ONL07X04ME-R	351
ONL02X02X01KP	327	ONL04X09FE	329	ONL07X04X01KE	333
ONL02X03X00BL	327	ONL05X01X01WI	332	ONL07X06X01BE	333
ONL02X04GR	327	ONL05X02X00MA-L	349	ONL07X07PI	334
ONL02X05FE	327	ONL05X02X00MA-R	349	ONL07X07X01CO-L	351
ONL02X06X01HI-L	348	ONL05X02X01BO	331	ONL07X07X01CO-R	351
ONL02X06X01HI-R	348	ONL05X02X01OX	416	ONL07X07X01FO	418
ONL02X07X01GR-L	348	ONL05X03GE	330	ONL07X09X01GR	333
ONL02X07X01GR-R	348	ONL05X03WE-L	349	ONL07X11HU	334
ONL03X01WA-L	348	ONL05X03WE-R	349	ONL08X01X01WI	334
ONL03X01WA-R	348	ONL05X03X01FL	330	ONL08X03X01CH-L	351
ONL03X02EL	328	ONL05X03X01OL-L	350	ONL08X03X01CH-R	351
ONL03X02X01BW	328	ONL05X03X01OL-R	350	ONL08X03X01OX	416
ONL03X02X01ME	328	ONL05X03X01RI	330	ONL08X03X01SC	334
ONL03X03ED	328	ONL05X03X01WA	331	ONL08X04X00EM	340
ONL03X03FE	328	ONL05X04X01NE	331	ONL08X04X01AS	333
ONL03X03SO	328	ONL05X05AR	331	ONL08X04X01ED	335
ONL03X04X01LF	328	ONL05X05CO	331	ONL08X04X01GR-L	351
ONL03X05X01AT-L	348	ONL05X05X01FO	418	ONL08X04X01GR-R	351
ONL03X05X01AT-R	348	ONL05X06HI	331	ONL08X07DU	335
ONL03X05X01LE-L	348	ONL05X06X01AN-L	350	ONL08X07TS-L	351
ONL03X05X01LE-R	348	ONL05X06X01AN-R	350	ONL08X07TS-R	351
ONL03X05X01WI-L	348	ONL05X06X01UR	331	ONL08X08X00MO	422
ONL03X05X01WI-R	348	ONL05X08X01GR	331	ONL08X08X00RA	422
ONL03X06X01NE-L	348	ONL05X08X01-L	350	ONL08X08X01AN-L	351
ONL03X06X01NE-R	348	ONL05X08X01-R	350	ONL08X08X01AN-R	351
ONL03X07X01FL-L	348	ONL05X09X01DA-L	350	ONL08X08X01CA	422
ONL03X07X01FL-R	348	ONL05X09X01DA-R	350	ONL08X12X01FL	334
ONL04X02SP	330	ONL05X09X01DR	416	ONL08X12X01PE	334
ONL04X03ME-L	349	ONL06X02GE	333	ONL08X13X01VE-L	351
ONL04X03ME-R	349	ONL06X02SK-L	350	ONL08X13X01VE-R	351
ONL04X03OS-L	349	ONL06X02SK-R	350	ONL08X20X01GR	334
ONL04X03OS-R	349	ONL06X02X01OX	416	ONL09X02X01CL	336
ONL04X04SH	330	ONL06X03QU	333	ONL09X02X01DN	334
ONL04X04TR	329	ONL06X06X01ST	332	ONL09X02X01WI	335
ONL04X04X01CA	422	ONL06X08X01LF	332	ONL09X03ER	335
ONL04X04X01FO	418	ONL07X02OD-L	350	ONL09X03X01GR	419
ONL04X04X01MO	422	ONL07X02OD-R	350	ONL09X03X01VE	335
ONL04X04X01RA	422	ONL07X02X01WR	333	ONL09X04NI	336
ONL04X06RB	330	ONL07X03PE-L	350	ONL09X04X01BO	335
ONL04X06X01FL	329	ONL07X03PE-R	350	ONL09X04X01RO	420
ONL04X06X01OX	330	ONL07X03X01AS	334	ONL09X04X01SP	420
ONL04X06X01SE-L	349	ONL07X03X01CL	328	ONL09X04X01SW	419
ONL04X06X01SE-R	349	ONL07X03X01OS	333	ONL09X05X01SH	335
ONL04X07X01DR	416	ONL07X03X01RO	420	ONL09X06KE	336
ONL04X07X01LF-L	349	ONL07X03X01SP	420	ONL09X09MA	336
ONL04X07X01LF-R	349	ONL07X03X01SW	419	ONL09X12X01LU	335
ONL04X07X01ZE-L	349	ONL07X04ME-L	351	ONL10X01X01FL	336

INDEX

PB03X03X01LY	82	PIR01X00BP	220	PML02X00RA	211,222
PB03X04FL	82	PIR01X00ME	218	PML02X00SU	212,222
PB03X07X01GI	81	PIR02X00DE	224	PML02X00VA	212,222
PB04X04CO	82	PIR02X00HI	226	PML02X01BE	214,225
PB04X04X01EM	82	PIR02X00JA	226	PML02X01CL	221
PB04X04X01NE	82	PIR02X00ME	220	PML02X01EG	221
PB04X04X01RE	82	PIR02X00MO	222	PML02X01EM	223
PB04X04X01WA	82	PIR02X00PE	224	PML02X01HA	224
PB04X06X01PM	81	PIR03X00BP	229	PML03X00CA	215,229
PB04X07X01BR	81	PIR03X00FA	233	PML03X00CL	233
PB04X09X01BR	81	PIR03X00HA	228	PML03X00EM	215,229
PB04X09X01JE	81	PIR03X00HO	227	PML03X00ER	229
PB04X11X01DE	81	PIR03X00MO	229	PML03X00HO	232
PB05X05X01OD	82	PIR04X00SW	234	PML03X00KI	230
PB05X05X01RE	83	PIR04X00TO	234	PML03X00LU	233
PB05X05X01TR	83	PIR07X00GR	241	PML03X01AL	226
PB05X08X01ME	81	PML00X00CL	201,217	PML03X01BE	232
PB05X09X01AD	81	PML00X00OD	201,217	PML03X01CH	230
PB06X09X01DI	81	PML00X00TR	200,217	PML03X01CL	225
PED31X16X01SB	70	PML01X00AB	205,219	PML03X01ED	214,228
PED36X18X02SB	70	PML01X00AR	210,221	PML03X01HE	228
PED36X18X02SP	70	PML01X00AS	204,219	PML03X01OS	228
PED40X09X01SE	70	PML01X00CL	207,220	PML03X01SM	227
PED40X18X01SB	70	PML01X00CR	221	PML03X01SW	230
PED40X20X02SB	70	PML01X00ER	205,219	PML03X02CL	226
PED43X14X02PC	71	PML01X00JA	207,219	PML03X02TR	231
PED45X14X01EM	71	PML01X00KD	206,220	PML04X00ED	234
PED48X11X02SB	71	PML01X00LA	208,220	PML04X00GO	234
PED48X24X02SB	71	PML01X00MD	203,218	PML04X00LE	239
PED52X16X02PF	71	PML01X00NE	203,218	PML04X00LI	246
PED57X14X01EM	71	PML01X00SE	205,219	PML04X01CL	235
PED57X16X04	71	PML01X00ST	203,218	PML04X01DI	237
PED61X20X00UC	71	PML01X00SW	207,220	PML04X01DU	215,234
PED61X20X00UP	71	PML01X00TI	210,220	PML04X01LY	237
PED62X20X00US	71	PML01X01AC	208,220	PML04X01MA	246
PED68X17X06ST	71	PML01X01BR	201,217	PML04X01SW	235
PED72X14X02SB	71	PML01X01DU	203,219	PML05X01BL	238
PIL05X90X02	72	PML01X01HI	208,221	PML06X01KI	240
PIL05X96X02	72	PML01X01KP	203,218	PML06X01SW	239
PIL06X104X02	72	PML01X01SK	209,221	PML06X02PN-1	240
PIL07X90X02	72	PML02X00AC	214,225	PML06X02PN-2	240
PIL07X90X02DP	72	PML02X00DE	211	PML06X02PN-3	238
PIL07X96X02	72	PML02X00FO	213,224	PML07X01FL	241
PIL07X108X02	72	PML02X00LO	212,223	PML07X01OD	242
PIL08X96X02DP	73	PML02X00MI	209,222	PML07X02DE	241
PIL08X100X02	72	PML02X00NE	222	PML08X01DU	243
PIL08X108X02	73	PML02X00OX	211,222	PML08X02BE	243
PIL09X90X02	73	PML02X00PO	213,225	PML09X02WA	243

PML09X03DE 243
 PML10X02HM 243

R

ROS01X01AT 364
 ROS01X01LA 361
 ROS02X02AC 413
 ROS02X02BE 415
 ROS02X02BL 361
 ROS02X02FL 361
 ROS02X02FW 364
 ROS02X02GL 418
 ROS02X02HU 361
 ROS02X02KE 414
 ROS02X02LO 361
 ROS02X02ME 362
 ROS02X02NA 361
 ROS02X02OX 365
 ROS02X02RA 415
 ROS02X02RE 417
 ROS02X02SP 413
 ROS02X03HI 416
 ROS02X04AS 417
 ROS03LO 361
 ROS03X03AC 413
 ROS03X03AR 361
 ROS03X03AU 412
 ROS03X03BE 415
 ROS03X03DG 410
 ROS03X03DN 365
 ROS03X03ED 410
 ROS03X03FL 361
 ROS03X03GL 418
 ROS03X03HE 362
 ROS03X03HO 365
 ROS03X03KE 414
 ROS03X03LF 411
 ROS03X03MD 411
 ROS03X03ME 412
 ROS03X03MO 361
 ROS03X03OD 365
 ROS03X03RA 415
 ROS03X03RE 417
 ROS03X03SK 365
 ROS03X03SP 413
 ROS03X03X00DG 410

ROS03X03X00ED 410
 ROS03X03X00LF 411
 ROS03X03X00MD 411
 ROS03X03X00SF 411
 ROS03X03X01ME 412
 ROS03X03X01SF 411
 ROS03X03X01SH 364
 ROS03X04EM 364
 ROS03X04HI 416
 ROS03X05AS 417
 ROS03X06HI 416
 ROS04FL 361
 ROS04MA 364
 ROS04X01TR 362
 ROS04X03SO 361
 ROS04X04AC 413
 ROS04X04AU 412
 ROS04X04BE 415
 ROS04X04GL 418
 ROS04X04KD 365
 ROS04X04LE 365
 ROS04X04MA 362
 ROS04X04MO 362
 ROS04X04RA 415
 ROS04X04RE 417
 ROS04X04SP 413
 ROS04X04VE 365
 ROS04X04X00CL 365
 ROS04X04X00DA 362
 ROS04X04X00LA 364
 ROS04X04X01KE 414
 ROS04X06AS 417
 ROS05X00LI 362
 ROS05X01BO 362
 ROS05X01FL 362
 ROS05X05AC 413
 ROS05X05AU 412
 ROS05X05BE 415
 ROS05X05BO 362
 ROS05X05DG 410
 ROS05X05GL 418
 ROS05X05KE 414
 ROS05X05LY 362
 ROS05X05ME 412
 ROS05X05MU 363
 ROS05X05NO 362
 ROS05X05RA 415
 ROS05X05RE 417

ROS05X05SF 411
 ROS05X05SP 413
 ROS05X05X01ED 410
 ROS05X05X01LF 411
 ROS05X05X01MD 411
 ROS05X07AS 417
 ROS06AS 363
 ROS06PM 363
 ROS06SN 363
 ROS06X05CL 364
 ROS06X05KI 364
 ROS06X06AC 413
 ROS06X06AU 412
 ROS06X06CH 363
 ROS06X06GL 418
 ROS06X06ST 363
 ROS06X06X01KE 414
 ROS07X03MA 364
 ROS07X07AC 365
 ROS07X07AU 412
 ROS07X07GL 418
 ROS07X07KE 364
 ROS07X07KP 364
 ROS08X08FA 365
 ROS08X08WA 364
 ROS09X09X01KE 414
 ROS15X15FA 365

S

SB08X05AN-L 366
 SB08X05AN-R 366
 SB08X05BR-L 366
 SB08X05BR-R 366
 SB08X05TR-L 366
 SB08X05TR-R 366
 SB08X05TY-L 366
 SB08X05TY-R 366
 SB08X06FL-L 367
 SB08X06FL-R 367
 SB08X06PE-L 367
 SB08X06PE-R 367
 SB08X07AS-L 367
 SB08X07AS-R 367
 SB09X06ER-L 367
 SB09X06ER-R 367
 SB09X07AB-L 367

INDEX

SB09X07AB-R	367	SCO17X10X08RO-L	376
SB09X07AT-L	367	SCO17X10X08RO-R	376
SB09X07AT-R	367	SCO19X07X06RI	377
SB09X07FL-L	367	SCO19X08X06RI	377
SB09X07FL-R	367	SCO23X14X09AN	377
SB09X07NS-L	367	SH09X04X12CH	374
SB09X07NS-R	367	SH10X06X07SH	374
SB10X07TE-L	368	SH13X06X03HI	374
SB10X07TE-R	368	SH17X09X05CH	374
SB11X06FVI-L	368	SH20X06X04HI	375
SB11X06LE-L	368	SH20X10X16DU	375
SB11X06LE-R	368	SH23X07X04OD	375
SB11X06VI-R	368	SH31X04X08WA	375
SB11X07AC-L	368	SUR09X29X06CL	325
SB11X07AC-R	368		
SB11X07AS-L	368	T	
SB11X07AS-R	368	TR07X	35
SB11X07AT-L	369	W	
SB11X07AT-R	369	Wood Gable Vents	92-113
SB11X07FL-L	369		
SB11X07FL-R	369		
SB11X07PE-L	369		
SB11X07PE-R	369		
SB11X07SP-L	369		
SB11X07SP-R	369		
SB11X07TR-L	369		
SB11X07TR-R	369		
SB12X06SC-L	369		
SB12X06SC-R	369		
SB12X07MO-L	369		
SB12X07MO-R	369		
SCO07X06X16TR	375		
SCO07X08X16SH	375		
SCO10X05X12AS	375		
SCO10X05X12SH	375		
SCO11X07X06SH	375		
SCO12X06X04AS	375		
SCO12X06X04TR	375		
SCO12X12X18SS	376		
SCO14X06X06BA	376		
SCO14X06X15AN-L	376		
SCO14X06X15AN-R	376		
SCO15X04X09SH	376		
SCO16X06X08AS	376		
SCO16X06X08TR	376		
SCO16X08X05BD	376		
SCO16X17X08OL	376		
SCO16X20X06PR	376		

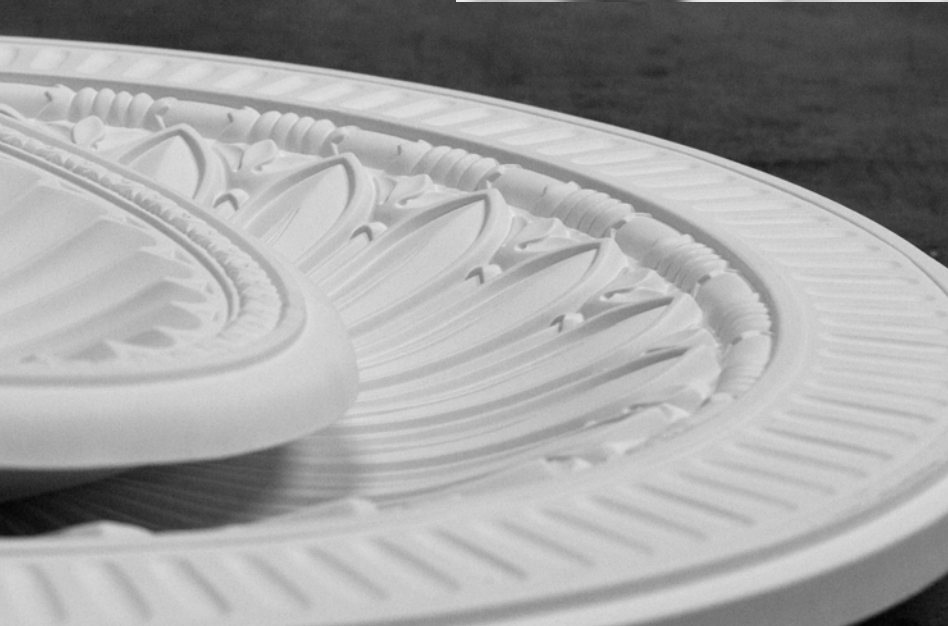



**PACIFIC COLUMNS &
ARCHITECTURAL DEPOT**
VOLUME VII

PACIFIC COLUMNS

505 W. Lambert Rd
Brea, CA 92821
www.pacificcolumns.com
(800) 294-1098 Toll Free
(714) 257-9600 Local

ARCHITECTURAL DEPOT

505 W. Lambert Rd
Brea, CA 92821
www.architecturaldepot.com
(888) 573-3768 Toll Free
(714) 706-4370 Local
(714) ~~257-9600~~ Fax



999999VOL007