



QuickRail BY EYPON
SYNTHETIC RAILING SYSTEM

Polish with a Purpose

QuickRail® Systems

Beautiful railings are made more durable, thanks to our special manufacturing process. They are virtually maintenance free, and resist decay, warping, fading, chipping, splintering and rust. And simple, step-by-step installation instructions help ensure all QuickRail products live up to their name.

How to Use This Section

For ease of use, the product groupings in this section of the catalog are organized by size, from smallest to largest, where applicable. Each product chart includes product images, dimensional data and part numbers to help specify, source and sell Fypon® QuickRail® synthetic railing systems.

How to Order

QuickRail® Systems

QuickRail rail kits are available for both straight and stair applications. Each kit includes a deluxe top rail, a flat bottom rail, spindles, a crush block, brackets, bracket covers and the necessary screws for fast installation. Rail kits can be attached to a wall, round column, newel post or porch post.

NOTE: QuickRail stair rail kits cannot be attached to round columns or 45° post applications.

First, plan your layout, as shown here, by determining the size and configuration of your porch, including any stairs. The most important step to building your order is creating an accurate layout. Check local building codes to determine minimum guardrail height, maximum rail span and structural post requirements for your area. Determine the number of rail and post kits you need to accommodate your layout.

Next, choose spindle style. Then find the part number of the rail kit that meets your style, length and height requirements.

Finally, determine size and style of any accessories needed to achieve the desired look.

QuickRail® System Accessories

A variety of accessories are available to create your own unique system, including post kits, post sleeves, gate kits, porch posts and grab rails. If you have an application where additional or unique connections are required, bracket and adapter kits are sold separately. Individual components are also sold separately.

Special Order Products

Some products shown in this catalog include special order options. This means the product is available in additional sizes or with additional accessories. Throughout this section, special order part numbers are marked with an asterisk (*).

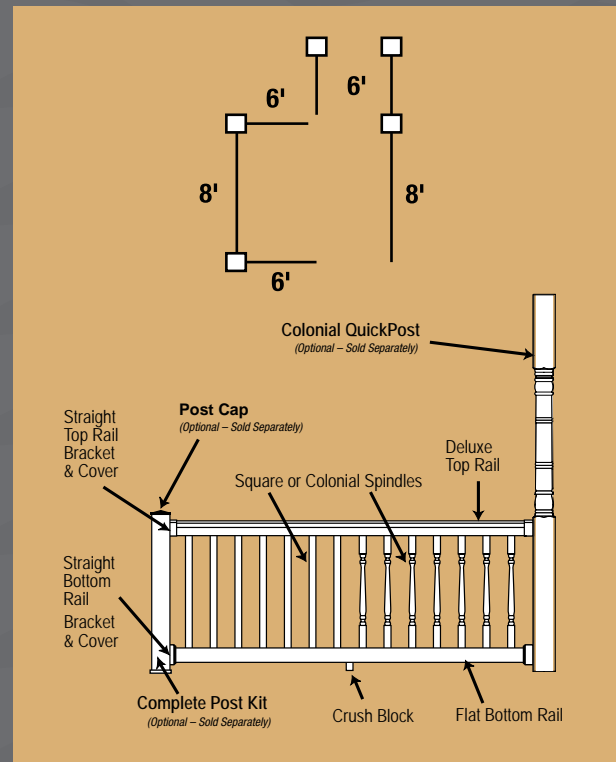

Building Code Compliance*

QuickRail products are building code compliant when installed on structural surfaces no more than 30" above ground. The 8' and 10' rail kits include a top rail aluminum insert that must be used in any installation. The 6' rail kits do not require an insert. In applications above 30", only rail lengths of 10' or less mounted between our ultra post kits or 4"x4" posts with post sleeves are building code compliant. The complete post kit with standard post mount can only be installed in applications that are less than 30" above ground.

Fypon has received confirmation from ICC Evaluation Service, LLC (ICC-ES), that its QuickRail synthetic railing systems comply with the provisions of the International Building Code and International Residential Code. The ICC-ES confirmation, published in evaluation report ESR-2601, will help code officials approve use of QuickRail systems under the codes. The Fypon evaluation report is available online at www.icc-es.org.

QuickRail® Railing Kits

Options & Features

- Height Options: 36" or 42" guardrail height
- Length Options: 6', 8', 10' or 12' nominal length
- Spindle Options: Colonial, square or glass
- Finish Color: White (standard) or tan (special order)
- Application: Straight or stair (30°-40° slope)
- Additional Accessories: Multi-angle brackets, 45° adapters and curved adapters are available as special order
- Conveniently packaged in one box, each kit includes a top rail, a bottom rail, spindles, brackets, bracket covers, a crush block, structural insert* and screws

Kit Contents

Straight & Stair Rail Kits

Each straight or stair rail kit includes the following:

- Deluxe Top Rail
- Top Rail Structural Insert (Not Included in 6' Kits)
- Colonial, Square or Glass Spindles
- Bottom Rail
- Crush Block
- Brackets & Bracket Covers
- Screw Pack

Finish Colors

QuickRail products come in our vibrant white or tan UV-protected finish.



Tan



White

NOTE: Printed colors may not be an accurate representation of actual product color.

* Structural insert is not included in the 6' kit.

NOTE: Always consult the local building code authority to determine suitability



Deluxe Rail with Square Spindles
(Posts Sold Separately)



Deluxe Rail with Colonial Spindles
(Posts Sold Separately)

Straight & Stair Rail Kits

QuickRail® Straight Rail Kits**

Deluxe Rail with Square or Colonial Spindles (Posts Sold Separately)

NOTE: Colonial spindle spacing is 3 1/4". Square spindle spacing is 3 7/8".

Description	Hand Rail Height	Spindle Style	No. of Spindles	Actual Rail Length	Bracket Style	White Part Number	Tan Part Number
6' Deluxe Rail Kit	36"	Colonial	14	70 1/2"	Straight	740636CLDF	74T636CLDF*
6' Deluxe Rail Kit	36"	Square	13	72"	Straight	740636SQDF	74T636SQDF*
6' Deluxe Rail Kit	42"	Square	13	72"	Straight	740642SQDF*	74T642SQDF*
8' Deluxe Rail Kit	36"	Colonial	19	94 1/8"	Straight	740836CLDF	74T836CLDF*
8' Deluxe Rail Kit	36"	Square	17	96"	Straight	740836SQDF	74T836SQDF*
8' Deluxe Rail Kit	42"	Square	17	96"	Straight	740842SQDF	74T842SQDF*
10' Deluxe Rail Kit	36"	Colonial	24	117 3/4"	Straight	741036CLDF	74T1036CLDF*
10' Deluxe Rail Kit	36"	Square	22	120"	Straight	741036SQDF	74T1036SQDF*
10' Deluxe Rail Kit	42"	Square	22	120"	Straight	741042SQDF	74T1042SQDF*
12' Deluxe Rail Kit	36"	Colonial	29	141 1/2"	Straight	741236CLDF*	74T1236CLDF*
12' Deluxe Rail Kit	36"	Square	26	144"	Straight	741236SQDF	74T1236SQDF*
12' Deluxe Rail Kit	42"	Square	26	144"	Straight	741242SQDF	74T1242SQDF*

QuickRail® Stair Rail Kits**

Deluxe Stair Rail with Square or Colonial Spindles (Posts Sold Separately)

NOTE: Colonial spindle spacing is 3 1/4". Square spindle spacing is 3 7/8".

Description	Hand Rail Height	Spindle Style	No. of Spindles	Actual Rail Length	Bracket Style	White Part Number	Tan Part Number
6' Deluxe Stair Rail Kit	36"	Colonial	11	78"	Stair	740636CLDS	74T636CLDS*
6' Deluxe Stair Rail Kit	36"	Square	11	78"	Stair	740636SQDS	74T636SQDS*
6' Deluxe Stair Rail Kit	42"	Square	11	78"	Stair	740642SQDS*	74T642SQDS*
8' Deluxe Stair Rail Kit	36"	Colonial	15	102"	Stair	740836CLDS	74T836CLDS*
8' Deluxe Stair Rail Kit	36"	Square	15	102"	Stair	740836SQDS	74T836SQDS*
8' Deluxe Stair Rail Kit	42"	Square	15	102"	Stair	740842SQDS	74T842SQDS*
10' Deluxe Stair Rail Kit	36"	Colonial	19	126"	Stair	741036CLDS	74T1036CLDS*
10' Deluxe Stair Rail Kit	36"	Square	19	126"	Stair	741036SQDS	74T1036SQDS*
10' Deluxe Stair Rail Kit	42"	Square	19	126"	Stair	741042SQDS*	74T1042SQDS*

Part numbers marked with an asterisk () are special order.

QuickRail® Straight Rail Kits**

Deluxe Straight Rail with Glass

Description	Hand Rail Height	Spindle Style	No. of Spindles	Actual Rail Length	Bracket Style	White Part Number	Tan Part Number
6' Deluxe Rail Kit	36"	Glass	6	72"	Straight	740636GLDF*	—

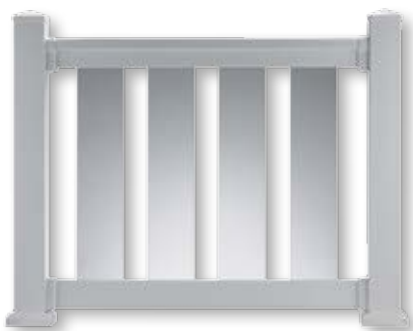

NOTE: This product can only be installed on structural surfaces less than 30" above ground.
CAUTION: Always exercise care when handling and installing glass products. Always use protective gloves and safety glasses.

** Always consult the local building code authority to determine suitability

System Accessories

Complete Post Kits

The complete post kit comes with a standard post mount and can be used to connect rail sections on substrates with elevation of 30" or less. Complete post kits include a cap, base, standard PVC post mount and the necessary hardware for installation on both pressure-treated wood decking and masonry surfaces.

- Kit Contents:**
- (1) Post Sleeve
 - (1) Taper Cap
 - (1) Post Base
 - (1) Standard PVC Post Mount
 - (1) Hardware Kit

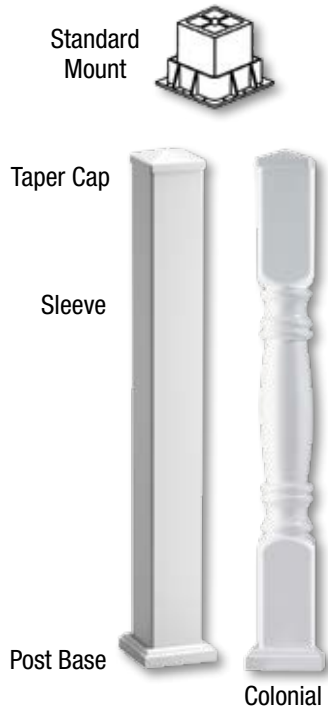

Post Size	Inside Width	Post Height	White Part Number	Tan Part Number
4" x 4" x 38"	3 5/8"	38"	40050438PK Plain Square	4T050438PK* Plain Square
4" x 4" x 38"	3 5/8"	38"	40050438CPK* Colonial	—
4" x 4" x 44"	3 5/8"	44"	40050444PK Plain Square	4T050444PK* Plain Square
Hardware Kit	Hardware kit is included in all complete post kits, but can also be purchased separately.		4005ACQHDR	

Ultra Post Kits

The ultra post is a structural, commercial-grade newel post that can be used on substrates with elevations higher than 30". Ultra post kits include a cap, base, structural post mount and the necessary hardware for installation on either wood / composite or concrete / masonry surfaces.

- Kit Contents:**
- (1) Post Sleeve
 - (1) Structural Post Mount
 - (1) Mounting Hardware (for ACQ pressure-treated wood or masonry)
 - (1) Taper Cap
 - (1) Post Base

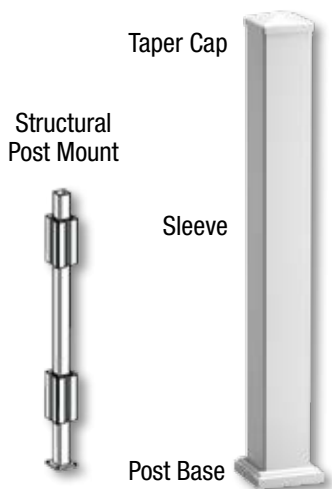

Post Size	Inside Width	Post Height	Substrate	White Part Number	Tan Part Number
4" x 4" x 38"	3 5/8"	38"	Wood or Composite	70050438WPK*	70T50438WPK*
4" x 4" x 38"	3 5/8"	38"	Concrete or Masonry	70050438CPK*	70T50438CPK*
4" x 4" x 44"	3 5/8"	44"	Wood or Composite	70050444WPK*	70T50444WPK*
4" x 4" x 44"	3 5/8"	44"	Concrete or Masonry	70050444CPK*	70T50444CPK*

* Part numbers marked with an asterisk (*) are special order.

System Accessories

Post Sleeves & Accessories

The post sleeve is a one-piece, hollow design that slides over an existing 4"x4" or 5"x5" support post. Post sleeves can be accented with a variety of caps and bases to customize your system.

Post Sleeve	Sleeve Style	Sleeve Size	Inside Width	Structural Support Size	White Part Number	Tan Part Number
	Plain	4" x 4" x 38"	3 5/8"	3 1/2"	40050438PS	4T050438PS*
	Plain	4" x 4" x 44"	3 5/8"	3 1/2"	40050444PS*	4T050444PS*
	Plain	4" x 4" x 48"	3 5/8"	3 1/2"	40050448PS*	4T050448PS*
	Plain	4" x 4" x 60"	3 5/8"	3 1/2"	40050460PS*	4T050460PS*
	Plain	4" x 4" x 96"	3 5/8"	3 1/2"	40050408PS*	4T050408PS*
	Plain	4" x 4" x 108"	3 5/8"	3 1/2"	40050409PS*	4T050409PS*
	Plain	5" x 5" x 38"	4 5/8"	4 1/2"	40050538PS*	—
	Recessed	5" x 5" x 38"	4 5/8"	4 1/2"	40050538RPPS*	—
	Plain	5" x 5" x 44"	4 5/8"	4 1/2"	40050544PS*	—
	Plain	5" x 5" x 96"	4 5/8"	4 1/2"	40050508PS*	—
	Plain	5" x 5" x 108"	4 5/8"	4 1/2"	40050509PS*	—

* Part numbers marked with an asterisk (*) are special order.

See next page for post caps and bases



System Accessories

Post Caps and Bases	Size and Style	Height	White Part Number	Tan Part Number
	4" Taper Cap	1 1/8"	40040404TC	4T040404TC*
	5" Taper Cap	1 1/8"	40040505TC*	—
	4" Ball Cap	4 5/8"	40040404BC*	4T040404BC*
	5" Ball Cap	5 3/4"	40040505BC*	—
	4" Gothic Cap	7 3/4"	40040404GC*	4T040404GC*
	5" Gothic Cap	9 3/4"	40040505GC*	—
	4" New England Cap	1 3/4"	40040404NC*	4T040404NC*
	5" New England Cap	2 1/8"	40040505NC*	—
	4" New England Base [^]	1 1/2"	40040404PB*	4T040404PB*
	5" New England Base	1 7/8"	40040505PB*	—

[^] Not compatible with complete post kit.

Gate Kits

Gate kits come with a latch, hinges and mounting hardware, and are available in 36" and 42" heights. The gate kit components are pre-cut to fit a 37 1/2" wide opening but can be trimmed for smaller applications. Be sure to check local building codes for any dimension requirements when planning your system layout.

Kit Contents:

- (1) Deluxe Top Rail
- (1) Flat Bottom Rail
- (5) Spindles
(Colonial or Square)
- (2) Post Sleeves
- (2) Taper Caps
- (1) Gate Hardware Kit

IMPORTANT: Gate kit should NOT be attached to complete post kit. It is recommended to attach the gate kit to a structural 4"x4" or 5"x5" treated post covered with a post sleeve.





















Description	Spindle Style	Gate Width	Kit Height	White Part Number	Tan Part Number
34" x 36" Gate Kit	Square	35"	36"	4436SQDFGK	44T36SQDFGK*
34" x 36" Gate Kit	Colonial	35"	36"	4436CLDFGK*	44T36CLDFGK*
34" x 42" Gate Kit	Square	35"	42"	4442SQDFGK*	44T42SQDFGK*

NOTE: This product can only be installed on structural surfaces less than 30" above ground.

* Part numbers marked with an asterisk (*) are special order.

System Accessories

Bracket & Adapter Kits

Straight Bracket Kit For use with QuickRail® Straight Rail Kits						White Part Number	Tan Part Number
						440900DFBK*	44T900DFBK*
(2) Top Rail Brackets	(2) Top Rail Bracket Covers	(2) Bottom Rail Brackets	(2) Bottom Rail Bracket Covers	(2) Screw Packs (Qty. 16)			
Stair Bracket Kit For use with QuickRail® Stair Rail Kits						White Part Number	Tan Part Number
						4409DFSUBK*	44T9DFSUBK*
(1) Top Rail Upper Stair Bracket Cover	(1) Top Rail Lower Stair Bracket Cover	(1) Bottom Rail Upper Stair Bracket Cover	(1) Bottom Rail Lower Stair Bracket Cover	(2) Top Rail Brackets	(2) Bottom Rail Brackets (2) Screw Packs (Qty. 16)		
Curved Adapter Kit To connect QuickRail® Straight Rail Kits to round columns						White Part Number	Tan Part Number
						440900DCBK*	74T700DCBK*
(2) Top Rail Curved Adapters	(2) Bottom Rail Curved Adapters			(1) Screw Pack (Qty. 8)			
Multi-Angle Bracket Kit For use with QuickRail® Straight Rail Kits in 22.5°-45° applications						White Part Number	Tan Part Number
						44070DFMBK*	44T70DFMBK*
(1) Top Rail Multi-Angle Connector	(1) Bottom Rail Multi-Angle Connector	(1) Top Rail Multi-Angle Pivot Bracket	(1) Bottom Rail Multi-Angle Pivot Bracket	(1) Screw Pack (Qty. 32)	(1) Rod Pack (Qty. 4 Rods; 8 Caps)		
45° Corner Post Bracket Kit For use with QuickRail® Straight Rail Kits in 45° applications						White Part Number	Tan Part Number
						74070FFPBK*	74T70FFPBK*
(1) Top Rail 45° Adapter	(1) Bottom Rail 45° Adapter			(1) Screw Pack (Qty. 8)			

* Part numbers marked with an asterisk (*) are special order.

Individual Components

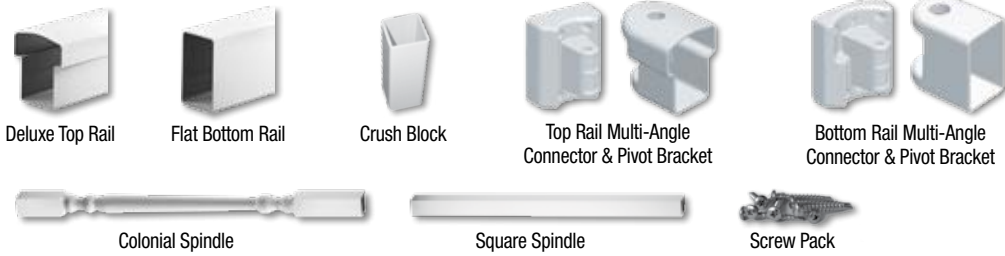

Description	White Part Number	Tan Part Number
6' Deluxe Top Rail - for Colonial Spindles	4407060CTR*	44T7060CTR*
6' Deluxe Top Rail - for Square Spindles	4407060STR*	44T7060STR*
6' Flat Bottom Rail - for Colonial Spindles	4007060CBR*	4T07060CBR*
6' Flat Bottom Rail - for Square Spindles	4007060SBR*	4T07060SBR*
6' Deluxe Stair Rail - for Colonial / Square Spindles	4407060SSR*	44T7060SSR*
6' Flat Stair Rail - for Colonial / Square Spindles	4007060SLR*	4T07060SLR*
8' Deluxe Rail - for Colonial Spindles	4407080CTR*	44T7080CTR*
8' Deluxe Rail - for Square Spindles	4407080STR*	44T7080STR*
8' Flat Bottom Rail - for Colonial Spindles	4007080CBR*	4T07080CBR*
8' Flat Bottom Rail - for Square Spindles	4007080SBR*	4T07080SBR*
8' Deluxe Stair Top Rail - for Colonial / Square Spindles	4407080SSR*	44T7080SSR*
8' Flat Stair Bottom Rail - for Colonial / Square Spindles	4007080SLR*	4T07080SLR*
10' Deluxe Rail - for Colonial Spindles	4407010CTR*	44T7010CTR*
10' Deluxe Rail - for Square Spindles	4407010STR*	44T7010STR*
10' Flat Bottom Rail - for Colonial Spindles	4007010CBR*	4T07010CBR*
10' Flat Bottom Rail - for Square Spindles	4007010SBR*	4T07010SBR*
10' Deluxe Sloped Top Rail - for Colonial / Square Spindles	4407010SSR*	44T7010SSR*
10' Flat Stair Bottom Rail - for Colonial / Square Spindles	4007010SLR*	4T07010SLR*
12' Deluxe Rail - for Colonial Spindles	4407012CTR*	44T7012CTR*
12' Deluxe Rail - for Square Spindles	4407012STR*	44T7012STR*
12' Flat Bottom Rail - for Colonial Spindles	4007012CBR*	4T07012CBR*
12' Flat Bottom Rail - for Square Spindles	4007012SBR*	4T07012SBR*
Colonial Spindle (1 1/2" x 1 1/2" x 32 3/4")	44043275CS*	44T43275CS*
Square Spindle (1 1/2" x 1 1/2" x 32 3/4")	44043275SS*	44T43275SS*
Square Spindle (1 1/2" x 1 1/2" x 38 3/4")	44043875SS*	44T43875SS*
Crush Block (1 1/2" x 8")	40071000CB*	4T071000CB*
Top Rail Multi-Angle Connector and Pivot Bracket (Includes 1 Rod and 2 Caps)	4407040MCT*	44T7040MCT*
Bottom Rail Multi-Angle Connector and Pivot Bracket (Includes 1 Rod and 2 Caps)	4407040MCB*	44T7040MCB*
Screw Pack (Qty. 32)	44070320SX*	44T70320SX*

* Part numbers marked with an asterisk (*) are special order.

QuickPost® Synthetic Porch Post

Structural Post with Lifetime Finish

QuickPost® synthetic porch posts are the perfect complement to our QuickRail® systems. Featuring the same lifetime finish as all QuickRail system components, the vibrant color is virtually maintenance-free and never needs to be painted.

- Structural post with steel insert
- Precise colonial detail
- Trim to fit your project
- Designed for use with QuickRail systems
- Virtually maintenance-free
- Limited lifetime warranty[^]

Product Details

- Shell is composed of UV-protected vinyl
- Internal core includes a structural, galvanized steel tube
- Kit includes mounting plates and screws
- Trim kit available (sold separately)

Product Options

- Sizes: 5" or 6" nominal width
(Actual widths are 4 1/4" or 5 1/4")
- Finish colors: White (standard) or tan (special order)
- Accessories: Trim kit available (sold separately)

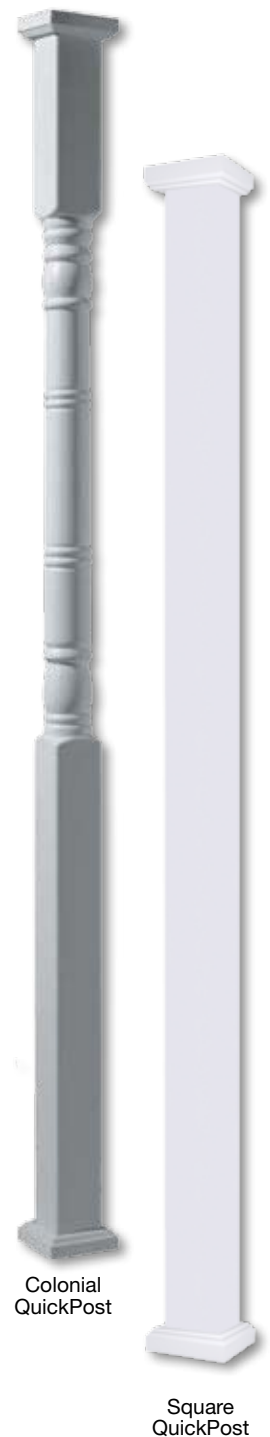
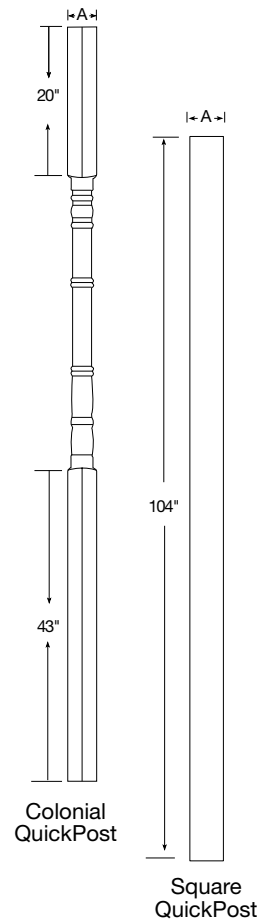

QuickPost® Synthetic Porch Post

Post Size	Actual Width (A)	Load Bearing Capacity	White Part Number	Tan Part Number	Post Style
4" x 4" x 8' 8"	4"	3,000 lbs.	40500488SQ	—	Square
5" x 5" x 8' 8"	5"	5,000 lbs.	40500588SQ	—	Square
5" x 5" x 8' 8"	4 1/2"	3,000 lbs.	40500588CL	4T500588CL*	Colonial
6" x 6" x 8' 8"	5 1/2"	5,000 lbs.	40500688CL	4T500688CL*	Colonial

QuickPost® Trim Kits (Sold Separately)

Trim Kit Size	White Part Number	Tan Part Number	Post Style
5" Trim Kit Fits 5" QuickPost	40020505TK	4T020505TK*	Colonial
6" Trim Kit Fits 6" QuickPost	400600PWTK	4T020606TK*	Colonial
4" Trim Kit Fits 4" QuickPost	405004SQTK	—	Square
5" Trim Kit Fits 5" QuickPost	405005SQTK	—	Square



Colonial Trim Kit
Sold Separately



Square Trim Kit
Sold Separately

* Part numbers marked with an asterisk (*) are special order.

[^] For complete details on our warranty, visit www.fypon.com.

NOTE: Dimensional drawings are approximate representations. Do not scale.

Grab Rail Handrail System

Fypon® grab rail perfectly complements all QuickRail® synthetic railing systems. The grab rail system is easy to install and can be mounted to QuickRail® complete post kits (in applications less than 30" above ground) or an existing wall. **IMPORTANT:** The illustration below is intended to show how the system components are used together. Grab rail must be attached to a guard rail in applications above 30".

- Meets ADA requirements
- White UV-protected finish resists fading
- Never needs painting
- Can be used with QuickRail systems
- Virtually maintenance-free
- Limited lifetime warranty[^]

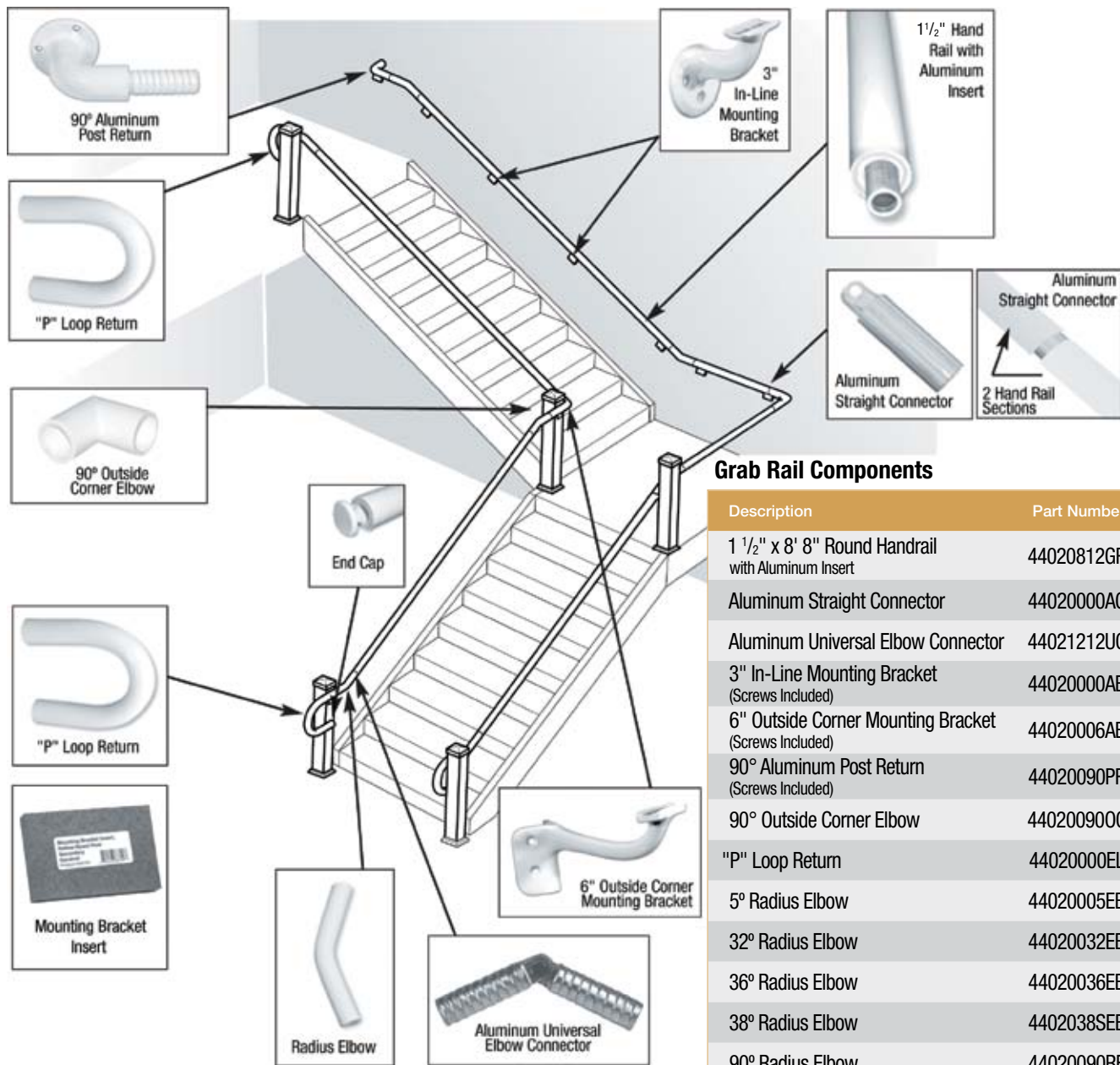

Grab Rail Components

Description	Part Number
1 1/2" x 8' 8" Round Handrail with Aluminum Insert	44020812GR*
Aluminum Straight Connector	44020000AC*
Aluminum Universal Elbow Connector	44021212UC*
3" In-Line Mounting Bracket (Screws Included)	44020000AB*
6" Outside Corner Mounting Bracket (Screws Included)	44020006AB*
90° Aluminum Post Return (Screws Included)	44020090PR*
90° Outside Corner Elbow	44020090OC*
"P" Loop Return	44020000EL*
5° Radius Elbow	44020005EB*
32° Radius Elbow	44020032EB*
36° Radius Elbow	44020036EB*
38° Radius Elbow	4402038SEB*
90° Radius Elbow	44020090RE*
End Caps	44020000EC*
Mounting Bracket Insert	44020000MB*

* Part numbers marked with an asterisk (*) are special order.

[^] For complete details on our warranty, visit www.fypon.com.

